

DECEMBER - 1945

A MCGRAW-HILL PUBLICATION

electronics

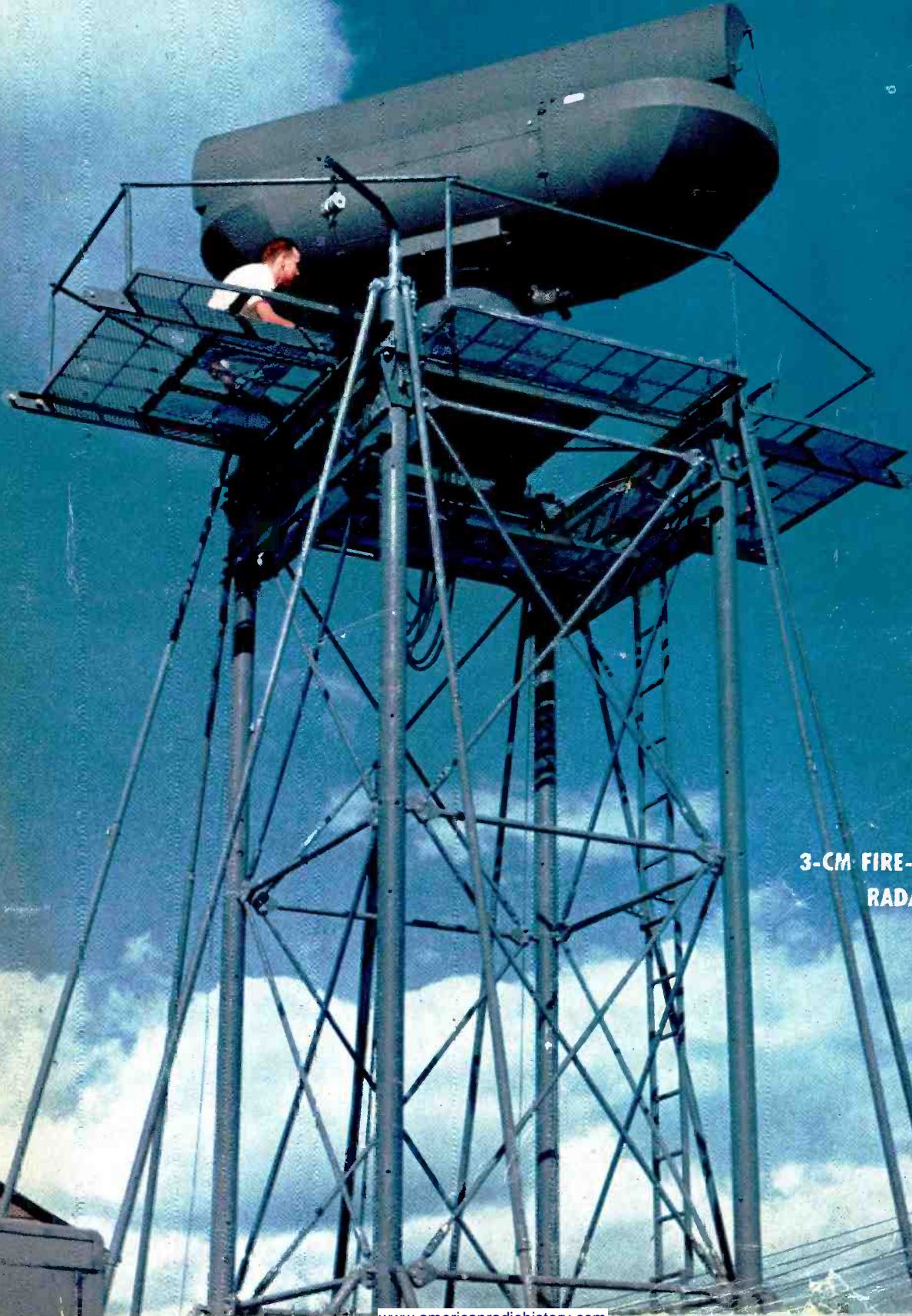

3-CM FIRE-CONTROL
RADAR

THE AMPEREXTRA FACTOR in SOUND TRANSMISSION

The Amperextra Factors of dependability and longevity represent important operational and replacement savings in the sound transmission field. Even in wartime, orders from essential civilian users were filled with fairly consistent regularity. Now, with nothing ahead but peace, the Amperextra Factor of service takes on an entirely new meaning for broadcasting stations, amateur radio operators and communications organizations. Your inquiries are invited.

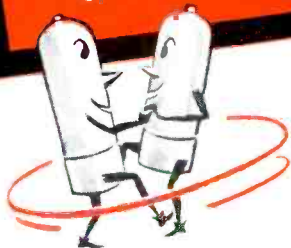

WHAT ONE USER SAYS...

... "the ease with which they can be driven to full output, the simplification of cooling arrangements, the relative immunity to heavy overloads, and the moderate plate voltages required result in a combination not easily surpassed."



AMPEREX INTERCHANGEABILITY

Amperex tubes will fit into all types of transmitters for which they are intended, and may be interchanged or used to replace tubes of other manufacture without need for circuit readjustment and without impairment of transmitter performance.

SPECIALLY PROCESSED GRAPHITE ANODES...

... in many of our exclusive designs make for more uniform temperature distribution, absence of change in characteristics with time, and a higher initial vacuum which keeps tubes harder and assures longer life.

AMPEREX

...THE HIGH PERFORMANCE TUBE

Many standard types of Amperex tubes are now available through leading radio equipment distributors. The Amperex Special Application Engineering Department will gladly work with you on the solution to your pressing problems.



Amperex Type ZB-120 Transmitting Tube. Filament voltage, 10-10.5 volts AC or DC. Filament current, 2 amperes. Amplification factor, 90. Grid-to-Plate Transconductance at 120 ma., 5000 micromhos. Direct Interelectrode Capacitances: grid-to-plate, 5.2 μ f; grid-to-filament, 5.3 μ f; plate-to-filament, 3.2 μ f.



Amperex Type HF-3000 Transmitting tube. Filament voltage, 21 to 22. Filament current, 40.5 amperes. Filament emission, 6 amperes. Amplification factor, 16. Grid-to-Plate Transconductance of plate current of 1 ampere, 6500 micromhos. Direct Interelectrode Capacitances: grid-to-plate, 10 μ f; grid-to-filament, 13 μ f; plate-to-filament, 4 μ f.



Amperex Type 891-R Transmitting Tube. Filament, two-unit type for single-phase or two-phase AC or DC operation—voltage per unit, 11; current per unit, 60 amperes; amplification factor, 8. Grid-to-Plate Transconductance at a plate current of 0.75 ampere, 4000 micromhos. Direct Interelectrode Capacitances: grid-to-plate, 30 μ f; grid-to-filament, 16 μ f; plate-to-filament, 3 μ f.



AMPEREX ELECTRONIC CORPORATION

25 Washington St., Brooklyn 1, N. Y., Export Division: 13 E. 40th St., New York 16, N. Y., Cables: "Arlab"
Canadian Distributor: Rogers Majestic Ltd. • 622 Fleet Street West, Toronto

electronics

A McGRAW-HILL
PUBLICATION

DECEMBER • 1945

MICROWAVE RADAR				Cover	
Antenna of the MPG-1, coast artillery unit described in detail in this issue (Bendix photo)					
FIRE-CONTROL RADAR MPG-1, by H. A. Straus, L. J. Rueger, C. A. Wert, S. J. Reisman, M. Taylor, R. J. Davis, and J. H. Taylor				92	
First description of microwave unit used for coast artillery gun-fire control					
GENERATOR-POWERED PROXIMITY FUZE, by R. D. Huntoon and B. J. Miller				98	
Development of an electronic, airborne-rocket detonator powered by a wind-driven generator					
THE SCR-584 RADAR				104	
Hitherto unpublished details of precision anti-aircraft gun-aiming radar					
LORAN RECEIVER-INDICATOR				110	
Circuit details and operating procedure, with examples of scope pattern sequence					
GEOPHYSICAL PROSPECTING EQUIPMENT, by David Sheffet				116	
Electronic circuits provide timing and automatic volume control for recording ground waves					
VOLUME EXPANDER DESIGN, by Robert W. Ehrlich				124	
Various types of program material are handled by a carefully designed expander					
CRYSTAL-DRIVEN MODULATOR FOR D-C AMPLIFIERS, by James A. Williams				128	
A 1000-cycle oscillator excites a rochelle-salt crystal that drives a carbon microphone					
CURVE-TRACER FOR ACOUSTIC DEVICES, by R. K. Hellmann				130	
Details of production fixtures and curve tracer used to check handset receivers					
MACHINE GUN RATE-OF-FIRE INDICATOR, by Arvid D. Peterson				134	
Device adaptable to non-military production uses rapid acceptance tests					
CHECKING UHF OSCILLATOR STABILITY, by L. E. Pinney				139	
A mixer for comparing the frequency of uhf oscillator against standard oscillator					
CASE STUDIES OF PRODUCTION, by Michael Lechner				140	
Practical examples of efficient use of workers and their tools					
A-C GALVANOMETER, by Arthur L. Quick and Henry D. Hall				147	
Theory and design of a sensitive visual null indicator for a-c bridge measurements					
REDUCTION OF HETERODYNE INTERFERENCE, by H. W. Belles				150	
Phase and amplitude components of interference are used to cancel each other					
ELECTRONIC TIMER FOR AIRCRAFT DE-ICER, by D. W. Blosser and G. R. Holt				152	
Four types of cycling for inflation and deflation of de-icer boots meet any condition					
VHF IMPEDANCE MEASUREMENTS, by D. Stanley Henry				156	
Description of the construction and operation of a Q-meter type instrument					
INTERFERENCE-FREE WEATHEROMETER, by W. B. Ritchie Agnew				160	
Automatically accelerated weathering tests, with photoelectric measuring of results					
VECTORIAL TREATMENT OF TRANSMISSION LINES, by J. P. Shanklin				162	
Feeding, matching, and stubbing problems are solved by means of vectors					
ANNUAL INDEX, VOLUME 18				428	
CROSSTALK	91	TUBES AT WORK	300	NEW BOOKS	404
NEW PRODUCTS	168	ELECTRON ART	330	BACKTALK	416
INDUSTRIAL CONTROL	232	NEWS OF THE INDUSTRY	364	INDEX TO ADVERTISERS	425

KEITH HENNEY, Editor; DONALD G. FINK, Executive Editor; W. W. MacDonald, Managing Editor; John Markus, Associate Editor; Vin Zeluff, Associate Editor; Assistant Editors—Frank Rockett, J. M. Heron, M. L. Matthey, and J. E. Grolimund; J. A. Myers, *Chicago Editor*; Frank Haylock, *Los Angeles Editor*; G. T. Montgomery, *Washington Editor*; Harry Phillips, *Art Director*

H. W. MATEER, Publisher; J. E. Blackburn, Jr., Director of Circulation, Electronics; Wallace B. Blood, Manager

DISTRICT MANAGERS, D. H. Miller, H. R. Denmead, Jr., New York; R. H. Flynn, New England; F. P. Coyle, R. E. Miller, Philadelphia; C. D. Wardner, A. F. Tischer, Chicago; E. J. Smith, Cleveland

Contents Copyright, 1945, by McGraw-Hill Publishing Company, Inc. All Rights Reserved

McGRAW-HILL PUBLISHING COMPANY, INCORPORATED

JAMES H. MCGRAW, Founder and Honorary Chairman

PUBLICATION OFFICE 99-129 North Broadway, Albany 1, N. Y., U. S. A.

EDITORIAL AND EXECUTIVE OFFICES 330 West 42nd St., New York 18, N. Y., U. S. A.

James H. McGraw, Jr., President; Curtis W. McGraw, Senior Vice-President and Treasurer; Howard Ehrlich, Vice-President (for business operations); Willard Chevalier, Vice-President (for editorial operations); Joseph A. Gerardi, Secretary; and J. E. Blackburn, Jr., Director of Circulation.
ELECTRONICS, December, 1945, Vol. 18, No. 12. Published monthly, price 50¢ a copy. Directory Issue \$1.00. Allow at least 10 days for change of address. All communications about subscriptions should be addressed to the Director of Circulation, 330 W. 42nd St., New York 18, N. Y.
Subscription rates—United States and possessions, Mexico, Central and South American countries, \$5.00 a year, \$8.00 for two years, \$10 for three years. Canada (Canadian funds accepted) \$5.50 a year, \$9.00 for two years, \$11.00 for three years. Great Britain and British Possessions, \$2 for two years, \$3 for three years. Canada three years. All other countries \$7.00 for one year, \$14.00 for three years. Please indicate position and company connection on all subscription orders. Entered as Second Class matter August 29, 1936, at Post Office, Albany, New York, under the Act of March 3, 1879. **BRANCH OFFICES:** 520 North Michigan Avenue, Chicago 11, Ill.; 68 Post Street, San Francisco 4; Aldwych House, Aldwych, London, W.C. 2; Washington, D. C. 4; Philadelphia 2; Cleveland 15; Detroit 26; St. Louis 8; Boston 16; Atlanta 3, Ga.; 821 So. Hope St., Los Angeles 14; 38-9 Oliver Building, Pittsburgh 22.

UNUSUAL DESIGNS AT



RESONANT TRANSFORMERS

This high voltage application involved a minimum size requirement. For maximum compactness, the final transformer produced has a turns ratio of 115/5,800, but a voltage ratio due to resonance of 115/10,000 V.



VARIABLE AC SATURATED INDUCTOR

This inductor is part of a voltage sensitive non-linear network. By adjustment of the inductor with a specific capacitor, peak non-linearity can be adjusted over a substantial range in voltage.

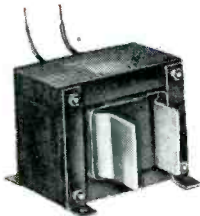

CONDENSER - PULSE WELDING TRANSFORMER

This transformer is designed for a small precise spot welding set. For this type of application, design factors include High Q and maximum surge power transfer. The transformer shown is the equivalent of 100 VA in size, but handles 1,000 VA pulses.

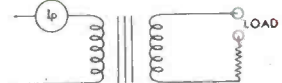

SPECIAL CONTROL TRANSFORMER

In this odd application, the requirements were that the primary current go down with increase in load current. In actual practice, when normal load is placed on the secondary, the primary current drops 50%.

The UTC application engineering section is available for your problem.

United Transformer Corp.

150 VARICK STREET

NEW YORK 13, N. Y.

EXPORT DIVISION: 13 EAST 40th STREET, NEW YORK 16, N. Y.,

CABLES: "ARLAB"



“Impossible” is a word that is not recognized by engineers. To dam a mighty river, tunnel under it or suspend a bridge across it—things such as these that once seemed pure imagination were made possible by instruments devised to refine and extend human faculties, to translate the precision of engineering thought into action.

Keuffel & Esser Co. is proud to have played so large a part in making such instruments widely available. In this way K & E equipment and materials have been partners of the engineer and draftsman for 78 years in shaping the modern world. So universally is this equipment used, it is self-evident that K & E have played a part in the completion of nearly every engineering project of any magnitude. Could you wish any surer guidance than this in the selection of your own “partners in creating”?

Not only for construction and building, but for setting up precision machine tools and long production lines, in the fabrication of large ships and aircraft, experienced engineers know that they can rely utterly on K & E transits and levels. Coated lenses for increased light transmission, precision-ground adjusting screws, chromium-coated inner center and draw tubes, completely enclosed leveling screws, improved achromatic telescopes—all these typify the advanced design of these instruments.

partners in creating



KEUFFEL & ESSER CO.

EST. 1867

NEW YORK • HOBOKEN, N. J

CHICAGO • ST. LOUIS • DETROIT • SAN FRANCISCO
LOS ANGELES • MONTREAL

How many ways can this
NEW BOOK help you?

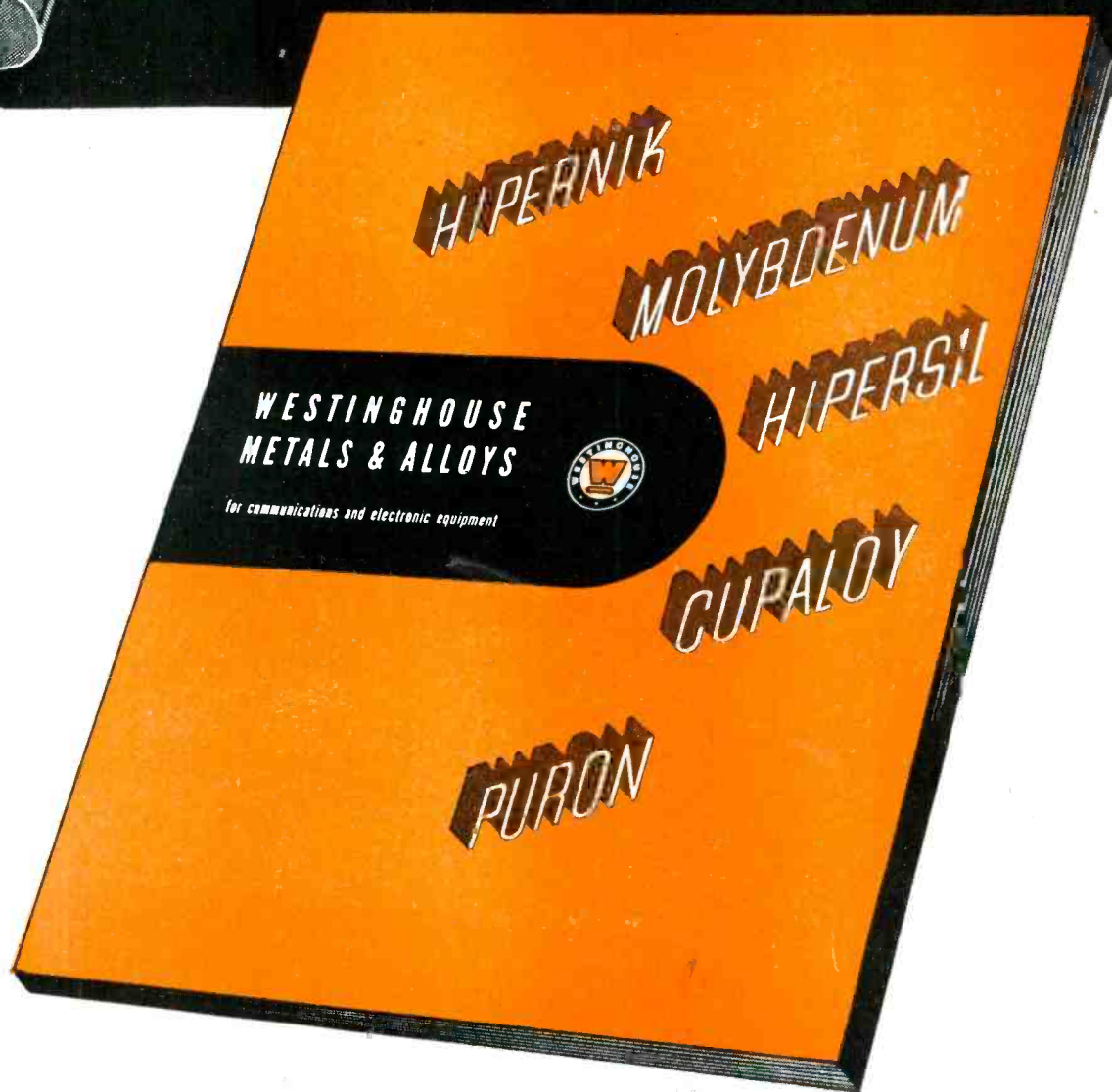

Here's real help for communications and electronic equipment designers . . . a fact-packed, thoroughly-illustrated book on Westinghouse metals and alloys.

This new book includes complete data, performance characteristics and applications for more than a dozen Westinghouse metals and alloys in five major classes: magnetic; electrodes, filaments and contacts; sealing; joining; and high temperature. An extensive table permits a detailed comparison of Westinghouse and other metals and alloys.

Your nearest Westinghouse office can supply you with copies of this new, authoritative book and a Westinghouse engineer will be glad to help you find

new ways to put these metals and alloys to work in your own product designs. Write today for your copy of B-3369. Westinghouse Electric Corporation, P. O. Box 868, Pittsburgh 30, Pa.

J-94672

Westinghouse
PLANTS IN 25 CITIES . . . OFFICES EVERYWHERE



... another Westinghouse guide prepared specifically for engineers who design electronic and communications equipment

This new, helpful book is another of many Westinghouse guides developed especially to help communications and electronic engineers gain outstanding performance in their designs.

Here is a quick check list of some of these metals and alloys described in the book . . . what they are, where to use them, what they will do.

Your nearest Westinghouse office will be glad to work in applying them to your own designs.

A QUICK CHECK LIST OF WESTINGHOUSE METALS AND ALLOYS

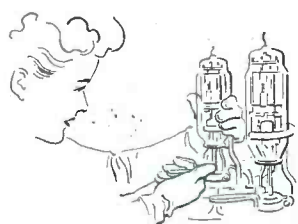

Sealing Alloys— Kovar "A" and Dumet are notable achievements in the search for tighter bonds between metal and glass. For example, Kovar "A" is easy to form and machine in large sections, seals perfectly into hard glass and solders readily. Dumet, on the other hand, is well suited to sealing with soft glass and is used extensively for leads and element supports.

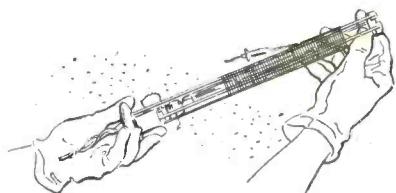

Electrodes, Filaments and Contacts— Cupaloy, molybdenum and tungsten are three Westinghouse metals with high purity and exceptional physical properties. Cupaloy—a nearly pure copper, alloyed with silver and chromium—offers many advantages because of its high yield and tensile strengths, contrasted with the softness of copper. Tungsten is hard, dense, has a high melting point, and makes a perfect seal with glass. "Moly", a metal with a promising future, finds wide usage because it can be made gas-free quite easily.



Magnetic— These five metals—Hipernik, Conpernik, Hipercu, Hipersil and Puron—practically blanket the needs of all non-permanent magnetic circuits, whether commonplace or critical. They offer a variety of characteristics in permeability, efficiency, purity and strength. Each has its own peculiar properties which—where applicable—improve performance far beyond the capacity of previously used materials. Puron—the magnetic characteristics of which are useful in fundamental research—is employed commercially as a spectroscopic standard. The other four are used entirely for magnetic circuits.

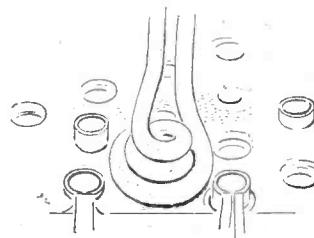

Brazing and Soldering Alloys— Westinghouse Phos-Copper, 35-Alloy and solders play an important role in every phase of industrial joining, and the particular characteristics of each metal fit it especially for certain joining operations. Comparative data and discussion make quick selection possible.

A New Catalog on Devices—

Westinghouse has just compiled a new catalog on general-purpose switches, relays and other devices. The devices listed in this catalog have been refined over many years to meet the exacting demands of engineers responsible for plant performance. The catalog contains data on the following classes of products: Indicating Lamps and Wiring Devices, Pushbuttons and Control Switches, General-Purpose Relays, Contactors, Pressure, Vacuum and Limit Switches, Timers, Protective Relays and Photoelectric Devices.



EQUIPMENT FOR THE
COMMUNICATIONS INDUSTRY

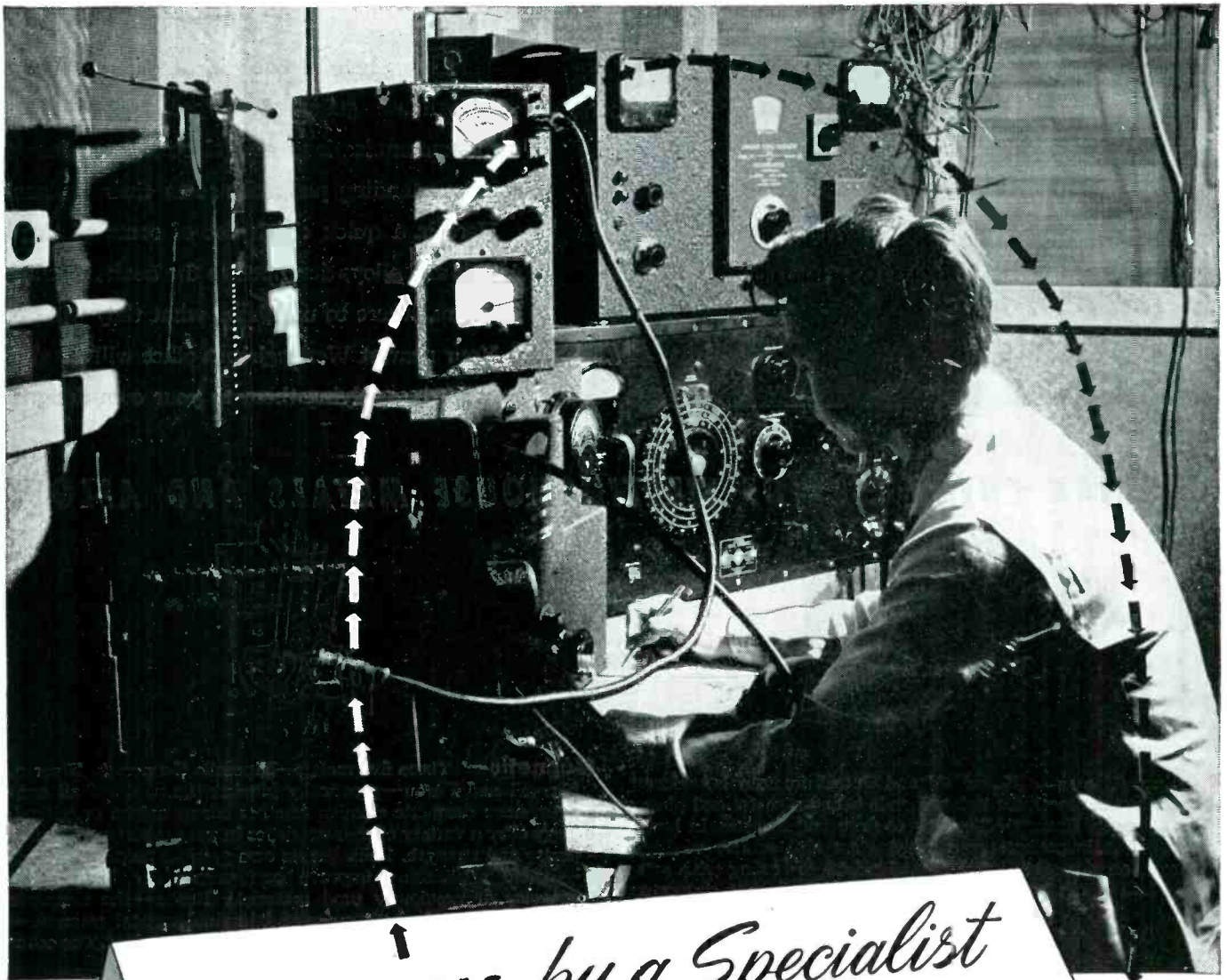

DIAGNOSIS *by a Specialist*

THE CURE OF RADIO NOISE is a highly specialized task that involves much more than simply "hooking a condenser across the line". It requires exact knowledge of the proper size and type of capacitor to use . . . of the correct place to add it to the noise-making circuit . . . of the necessary length or positioning of connecting leads . . . and of many other seemingly trivial, but actually vital, bits of information that cannot rightfully be expected of the electrical design engineer.

This exact knowledge is available to you when you must provide radio silence for electrical apparatus. Just send us the offending equipment and we will measure its radio noise output according to standard specifications, will design the most efficient Filterette to cure the noise, will specify the proper means of installing it, and, upon your adoption of our recommendations, will authorize your use of the FILTERIZED label that tells buyers your apparatus will not interfere with radio reception. This service is free to users of Tobe Filterettes . . . write for details.



TOBE DEUTSCHMANN CORPORATION-CANTON, MASSACHUSETTS

ORIGINATORS OF FILTERETTES . . . THE ACCEPTED CURE FOR RADIO NOISE

December 1945 — ELECTRONICS

MICA CERAMIC INSULATION

Molded TO YOUR SPECIFICATIONS

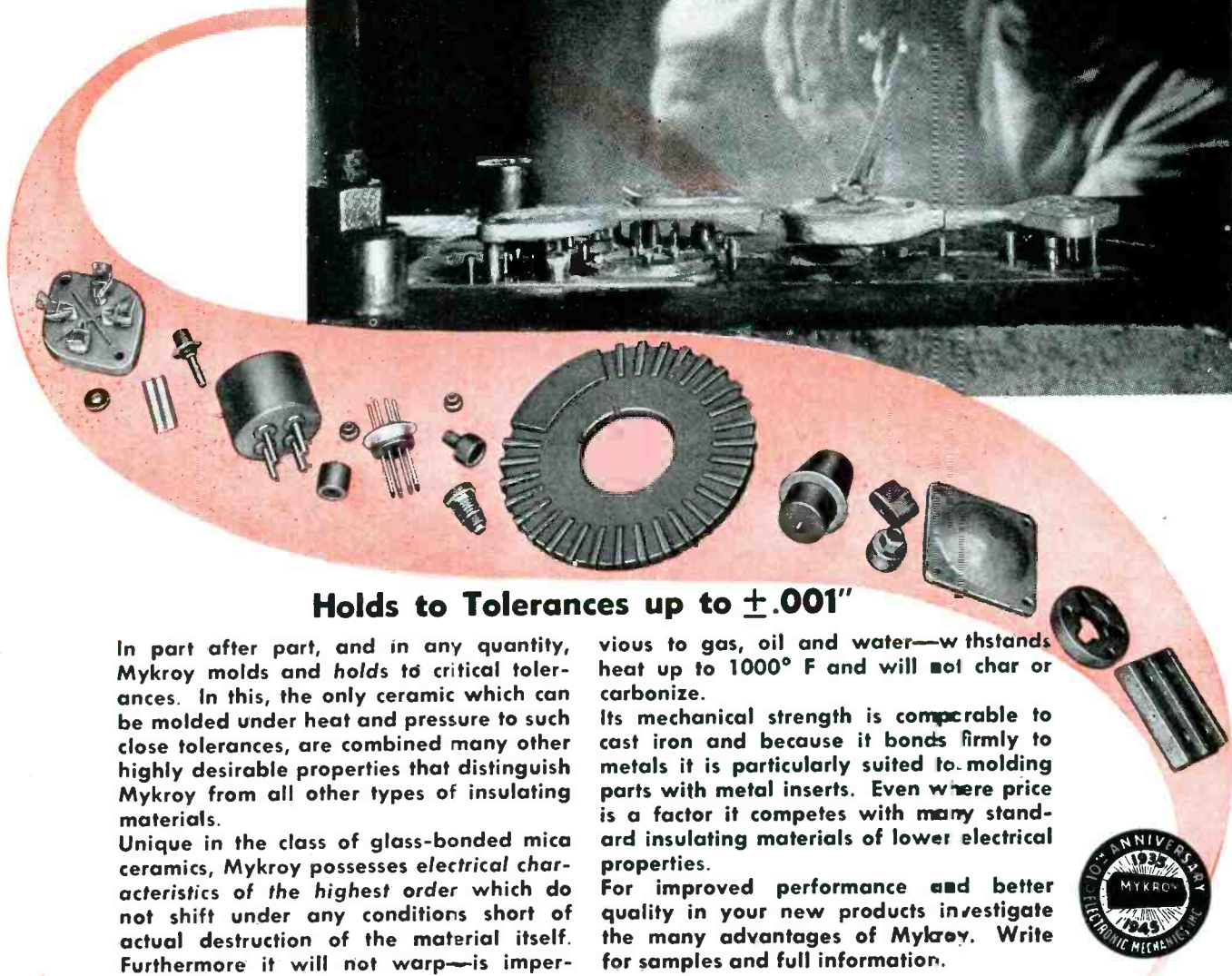

Holds to Tolerances up to $\pm .001''$

In part after part, and in any quantity, Mykroy molds and holds to critical tolerances. In this, the only ceramic which can be molded under heat and pressure to such close tolerances, are combined many other highly desirable properties that distinguish Mykroy from all other types of insulating materials. Unique in the class of glass-bonded mica ceramics, Mykroy possesses electrical characteristics of the highest order which do not shift under any conditions short of actual destruction of the material itself. Furthermore it will not warp—is imper-

vicious to gas, oil and water—withstands heat up to 1000° F and will not char or carbonize. Its mechanical strength is comparable to cast iron and because it bonds firmly to metals it is particularly suited to molding parts with metal inserts. Even where price is a factor it competes with many standard insulating materials of lower electrical properties. For improved performance and better quality in your new products investigate the many advantages of Mykroy. Write for samples and full information.



MADE EXCLUSIVELY BY

ELECTRONIC MECHANICS INC.

70 CLIFTON BLVD., CLIFTON, N. J.
 CHICAGO 47; 1917 N. Springfield Ave., Tel. Albany 4310
 EXPORT OFFICE: 89 Broad Street, New York 4, New York

A-C's Electronic Heater Gives You

NEW A-C WAY

A-C's Electronic Heater cuts production corners with new service features, wide application range.

STURDY, Long-Life Oscillating Tubes — fully protected by overload relays, water filters and pressure switches.

NEW Coupling System, developed by A-C, keeps losses low, permits adaptation to most applications without use of radio frequency transformers.

CHOKE COIL protects rectifier tubes from damage by high-frequency radio currents.

HEAVY-DUTY Transformer for handling overloads, other extreme operating conditions.

3-PHASE Rectifying System obtains maximum power from electronic heater, prevents unbalanced load on power lines.

INDIVIDUAL Filament Transformer for each rectifier tube, easy to get at.

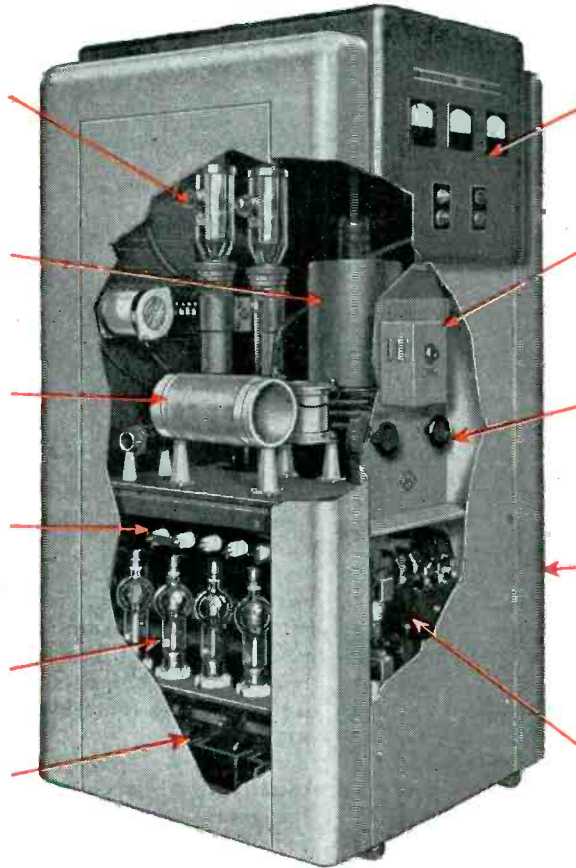

LARGE Indicator Panel for easy reading — shows at a glance when power is on, grid and plate currents, filament voltage.

AUTOMATIC Timer controls heat sequence from 2/10 seconds to 2 minutes, makes unit easy for unskilled operators to use.

ALL Controls on one panel for easy change in applications. No other internal adjustments needed. Protected from tampering by door and lock.

MODERN Industrial Cabinet encloses complete unit. All-Steel construction. Mounted on casters for mobility.

SAFETY FEATURES: Heavy-duty control, high water-temperature switch, fuses, interlocking switches on doors to protect operators.

Pioneer Builders of Electronic Equipment for Industry.

Allis



Fast, Uniform Production! Compare—

vs. OLD WAY!

A-C's Electronic Heater is clean, automatic — easy to operate . . . increases output, cuts cost.

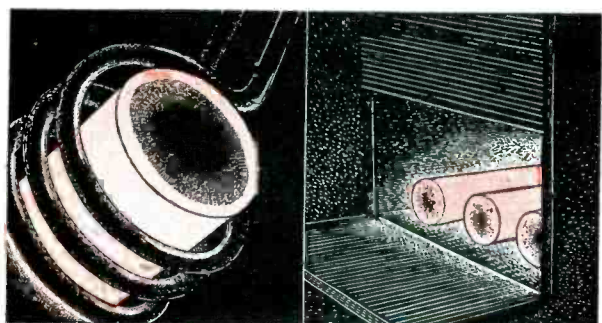

FAST Electronic Heat vs. **SLOW Furnace Heat**

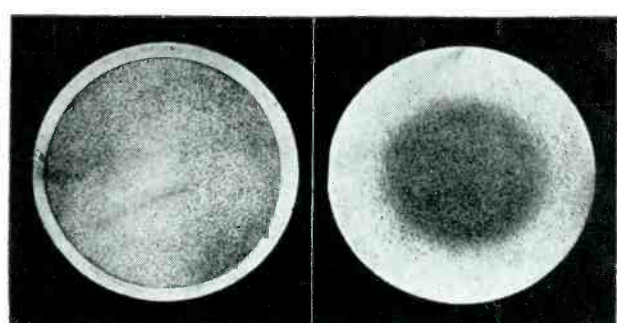

NEW Controlled Heat vs. **OLD Uncontrolled Heat**

A-C's Electronic Heater doubles and redoubles output of hardened metal parts because entire heating operation can be completed in a matter of seconds! Compare this with slow heat, time-waste of conventional methods.

Compare ideal hard surface and tough core of metal at left as treated by Allis-Chalmers Electronic Heater . . . with deep, irregular hardening and brittle core of metal at right, as treated by conventional methods.

INDUCTION HEATING at its newest and finest — that's what Allis-Chalmers Electronic Heater offers you! This great, new all-in-one production tool gives you flexible, selective, controllable heat for brazing, annealing, forging — yet it's simple to operate, requires no special skills. Write for further details about this modern answer to many modern production problems, or send samples for free laboratory test. No obligation. **ALLIS-CHALMERS, ELECTRONIC DEVICES SECTION, MILWAUKEE, WISCONSIN.**

A 1972

HEAR THE BOSTON SYMPHONY: Saturday, American Broadcasting Co.

Chalmers MILWAUKEE WISCONSIN

new

VARIABLE-TUNING CAPACITOR TECHNIQUE

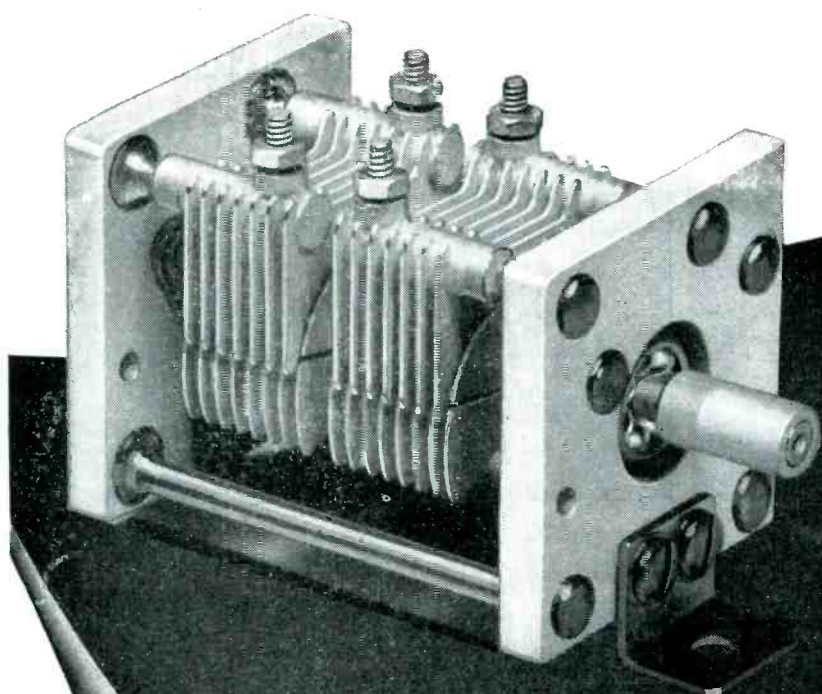

Send card for mechanical and electrical specifications.

Here's the answer to your UHF design problems. Noiseless operation — no rotor contacts — symmetrical layout. The new "VU" type variable capacitors can be used in conventional tuned circuits at frequencies as high as 500 megacycles. Write for folder with full technical data.



HAMMARLUND

THE HAMMARLUND MFG. CO., INC., 460 W. 34TH ST., NEW YORK 1, N.Y.
MANUFACTURERS OF PRECISION COMMUNICATIONS EQUIPMENT

December 1945 — ELECTRONICS



High power output, long life, feature these transmitting tube stalwarts!

- TYPE GL-892
Water-cooled . . . \$170
- TYPE GL-892-R
Forced-air-cooled . \$345

HERE is *proved* power, dependability, and long service life for the large AM transmitter owner or the manufacturer using electronic heating. General Electric Types GL-892 and GL-892-R have demonstrated their reliability in broadcasting and industrial sockets operating 24 hours a day, 7 days a week. With broad applications as high-power amplifiers, modulators, and oscillators, Types GL-892 and GL-892-R also are adaptable as to filament supply, their 2-unit filament permitting operation from 2-phase or single-phase a-c, as well as from d-c. For complete data to supplement the basic ratings at the right, see your nearest G-E Office or distributor, or write *Electronics Department, General Electric Company, Schenectady, N. Y.*



CHARACTERISTICS

Three-electrode high-vacuum power tubes for use as amplifiers and modulators in broadcasting and communications equipment—also oscillators in industrial electronic heating. Besides Types GL-892

and GL-892-R shown above, Types GL-891 and GL-891-R also are available at the same prices, and are similar in design characteristics except for the amplification factor, as given below.

Rating	GL-892	GL-892-R	GL-891	GL-891-R
Filament voltage	11 v	11v	11v	11 v
Filament current	60 amp	60 amp	60 amp	60 amp
Max plate voltage	15,000 v	12,500 v	12,000 v	10,000 v
Max plate current	2 amp	2 amp	2 amp	2 amp
Max plate input	30 kw	18 kw	18 kw	15 kw
Max plate dissipation	10 kw	4 kw	6 kw	4 kw
Amplification factor	50	50	8	8

Notes: (1) Filament voltage and current given above, are per unit of 2-unit filament. (2) Maximum frequency for all four tube types is 1.6 megacycles at max plate input; up to 20 megacycles at reduced ratings.

Come to GENERAL ELECTRIC with any special tube problems. A staff of experienced G-E tube engineers will work with you closely to meet your application or replacement needs.

TRANSMITTING, RECEIVING, INDUSTRIAL,
SPECIAL PURPOSE TUBES • VACUUM
SWITCHES AND CAPACITORS

GENERAL ELECTRIC

161-D12-8850



MICRO-TEL RELAY

Television's first MICROWAVE link

GENERAL ELECTRIC'S Micro-Tel relay—first 2000-megacycleradio relay in history—heralds a new era in network operation that will bring television and FM to more people at less cost.

● This simple relay, which eliminates connecting wire lines and costly right-of-ways, consists of a low-power microwave FM transmitter, a microwave FM receiver, and a highly directional transmitting and receiving antenna system which gives each watt of transmitter power the effectiveness of approximately one million watts. The system is simple, economical and provides unattended operation.

● Today, General Electric is testing a Micro-Tel link between the studio and transmitter of its great television station WRGB in Schenectady—a distance of 12½ airline miles.

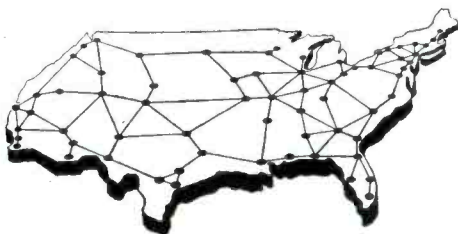

Soon, the world's first television microwave relay—equipped by G. E. and operated by the International Business Machines Corp.—will be added. This relay will extend to New York, Philadelphia, Baltimore, and Washington. Additional links will follow . . . for television programs, full fidelity channels for network broadcasting, facsimile channels, and multiple business machine channels—simultaneously in both directions.

● Further expansion of this network and the establishment of

others will bring television, broadcasting, and business machine services to smaller communities.

● Whether your requirements are for Micro-Tel relays, complete television broadcast stations, or Intra-Tel systems, look to General Electric for your equipment. Plan now to visit Schenectady to study G-E broadcast facilities. Wednesdays and Fridays are "open house" days. Write for the folder "How to Get To Schenectady," or ask your G-E broadcast equipment representative to help you plan your visit. Electronics Dept., General Electric Company, Schenectady 5, N. Y.

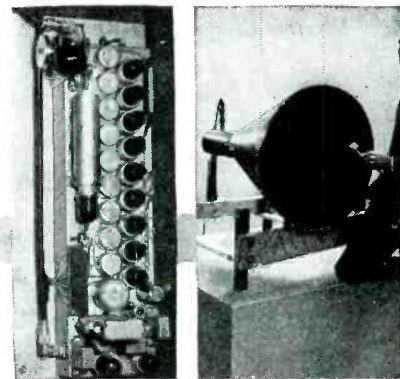

Receiving antenna and receiver for General Electric experimental Micro-Tel link in Schenectady. extreme simplicity of installation. The horn antenna is only 2 feet in diameter.

Authentic Guide to Television Programming

Write for the new book "Television Show Business," by Judy Dupuy. Published by General Electric. \$2.50 per copy. Address: Electronics Department, General Electric Company, Schenectady 5, N. Y.

For earliest possible delivery of your broadcast equipment, place your order now.

STUDIO AND STATION EQUIPMENT • TRANSMITTERS

GENERAL ELECTRIC

156-D3-6912

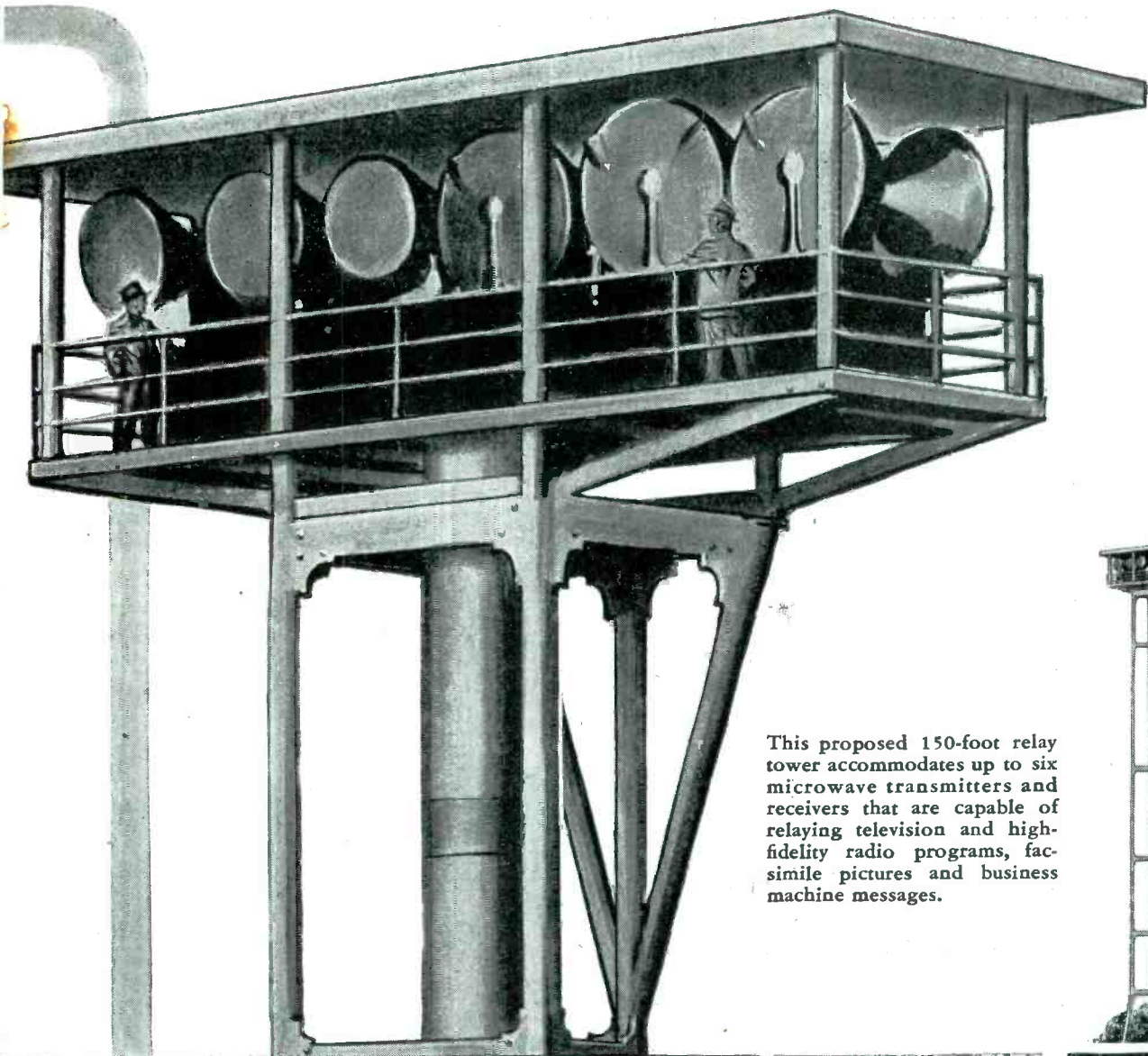

This proposed 150-foot relay tower accommodates up to six microwave transmitters and receivers that are capable of relaying television and high-fidelity radio programs, facsimile pictures and business machine messages.

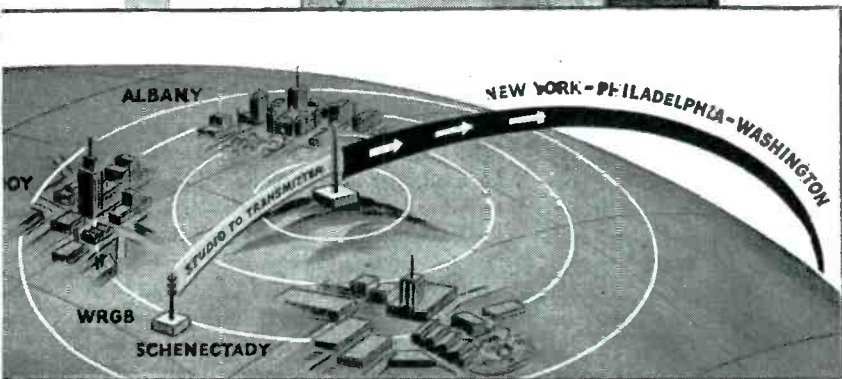
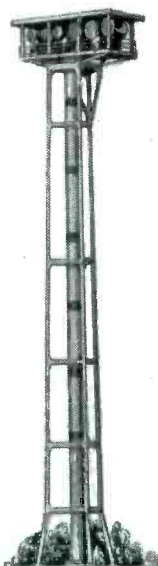

The G-E microwave television link. With the Micro-Tel relay, G.E. contributes another major development in television and broadcasting.

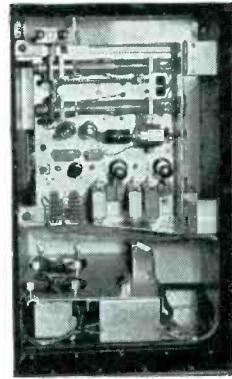
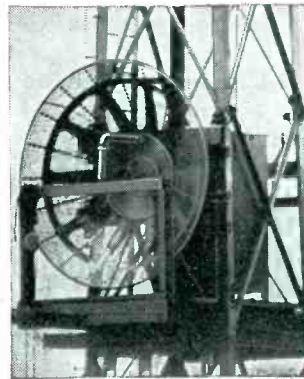

Micro-Tel link transmitter and antenna with highly directional reflector atop mast at WRGB. This system gives each transmitted watt of output the effectiveness of approximately 1,000 watts.

Lighthouse tubes make television microwave relaying possible. For maximum station dependability and performance, use G-E electronic tubes.

ANTENNAS • ELECTRONIC TUBES • HOME RECEIVERS

AM • TELEVISION • FM

See G.E. for all three!

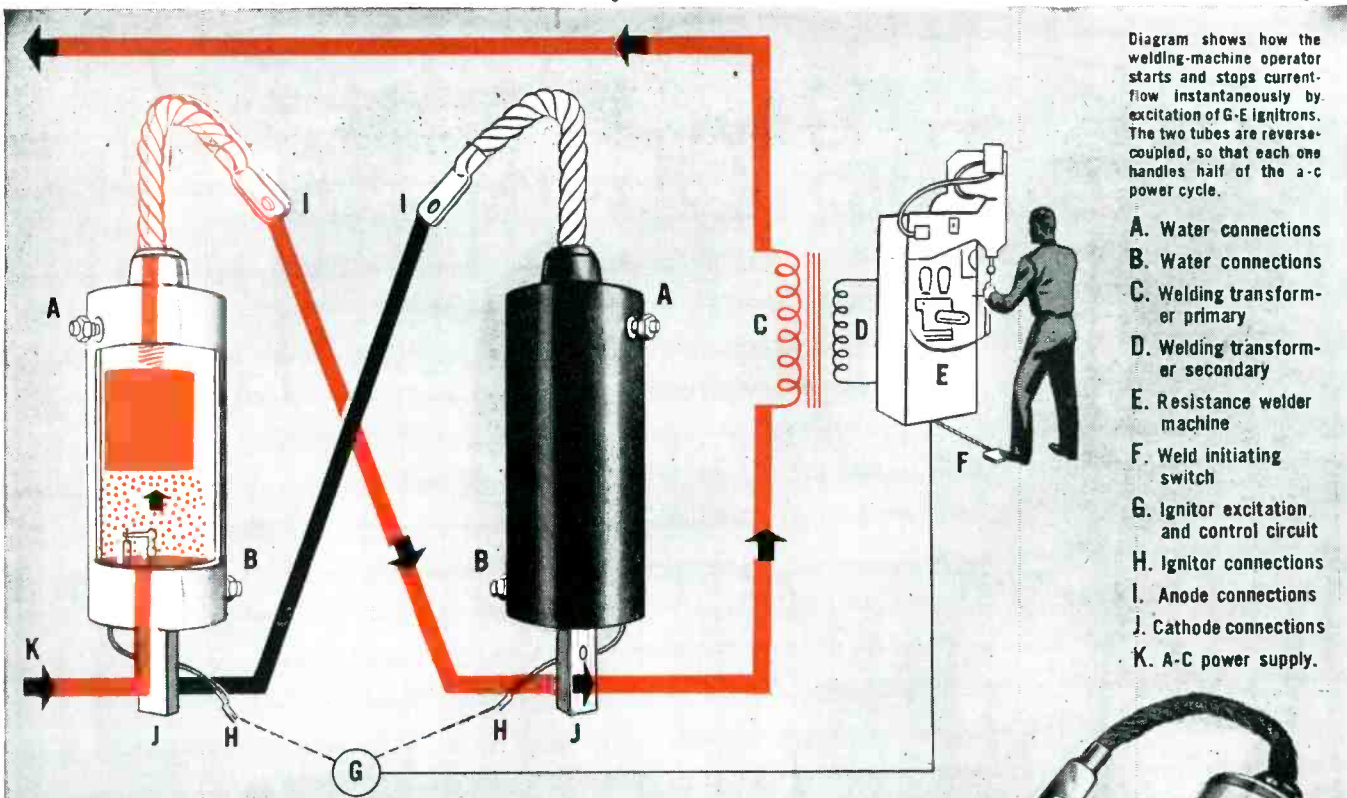

Diagram shows how the welding-machine operator starts and stops current-flow instantaneously by excitation of G-E ignitrons. The two tubes are reverse-coupled, so that each one handles half of the a-c power cycle.

- A. Water connections
- B. Water connections
- C. Welding transformer primary
- D. Welding transformer secondary
- E. Resistance welder machine
- F. Weld initiating switch
- G. Ignitor excitation and control circuit
- H. Ignitor connections
- I. Anode connections
- J. Cathode connections
- K. A-C power supply.



IGNITRONS "trigger" the heavy currents for resistance welding



AN important use of G-E ignitron tubes is shown above—controlling the primary current of resistance welders. The same benefits of split-second, positive "valve" action, with no mechanical linkage and no arcing between movable contacts, are provided by G-E ignitrons for other control circuits—furnace, motor, etc.—involving heavy electrical currents.

- Current control is but one of this tube's functions in industry. Another is current conversion—a-c to d-c. Here ignitrons offer the advantages of silent operation, no rotating parts, no need for lubrication,

no mechanical upkeep.

- Steel-jacket construction and mercury-pool type cathode, among other features, make the G-E ignitron sturdy, dependable, and long-lived. Learn more about this versatile electronic tube from G. E.'s new Booklet ETI-21, "Ignitron Tubes and How They Are Used." Its 24 profusely illustrated pages, complete with selected circuits, tell the full story of ignitrons and how they serve industrially. Telephone your nearest G-E office or distributor, or write *Electronics Department, General Electric Company, Schenectady 5, New York.*

IGNITRON FG-235-A . . . \$75.

This tube is one of the most widely used G-E ignitrons. It is a steel-jacketed, water-cooled, gas-filled triode with mercury-pool cathode, used for welder and other heavy current controls, and as a low-power current converter. For welder-control service, ratings are: max kva demand 1,200, with corresponding avg anode current 75.6 amp—max avg anode current 140 amp, with corresponding kva demand 400. (These ratings are for voltages of 600 v rms and below.) Ignitor requirements are 200 v and 30 amp. . . . Ratings for current conversion will be supplied on request, in which case please include a brief description of the application or circuit.

G. E. HAS MADE MORE BASIC ELECTRONIC TUBE DEVELOPMENTS THAN ANY OTHER MANUFACTURER

GENERAL ELECTRIC

162-D12-6850

TRANSMITTING, RECEIVING, INDUSTRIAL, SPECIAL PURPOSE TUBES ★ VACUUM SWITCHES AND CAPACITORS

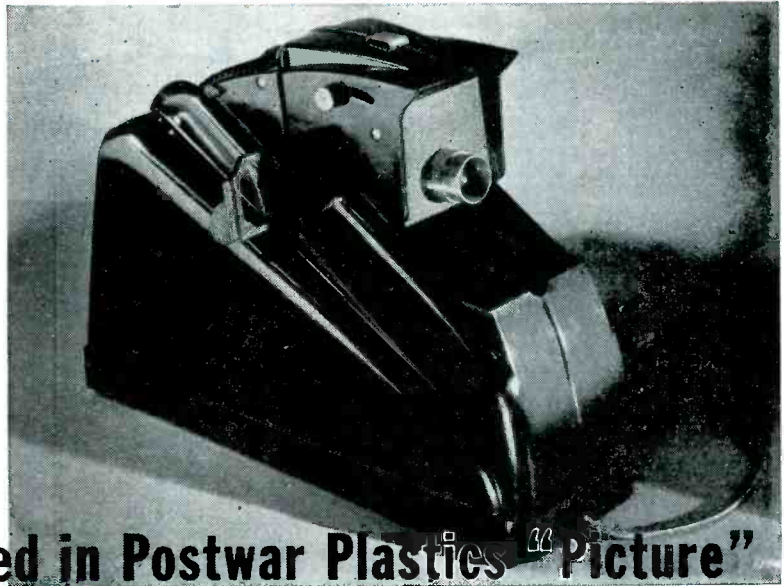
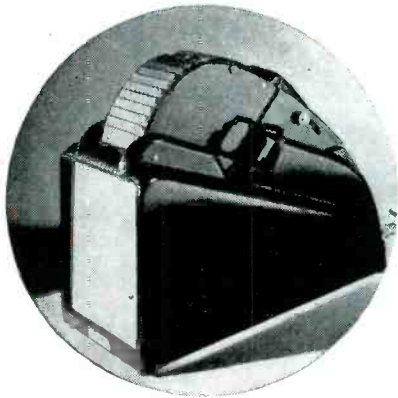

Phenolics featured in Postwar Plastics "Picture"

The phenolics are the most versatile of all plastics. Naturally, this makes their use practically universal throughout industry. In the electrical manufacturing field, for example, you will find phenolic molding compounds being used for literally thousands upon thousands of vital parts. The Novex Combination Projector Viewer shown above serves as an excellent illustration of this point. Its sturdy heat-resistant plastic housing was molded from a Durez phenolic compound.

This Novex Combination Projector Viewer effectively demonstrates the practical, sales-stimulating use to which Durez phenolic molding compounds can be put. Its durable, eye-appealing 14"-long body is molded in one piece. The complete unit embodies several molded Durez parts. With molded-in inserts, these, naturally, help to make assembly a simple process and keep production costs at a minimum.

Heat-Resistant Housing

By molding the housing for this Combination Projector Viewer of Durez, the manufacturers gain the heat-resisting and heat-insulating characteristics so necessary for the efficient operation of a machine of this type. Furthermore, a rugged yet lightweight construction results.

Properties of the Phenolics

Just as the Novex Corporation found a Durez phenolic plastic that fitted their job, so have many other manufacturers. Such desirable properties as heat and moisture resistance and dielectric strength make Durez compounds of unusual value to electrical manufacturers. Additional inherent characteristics such as highest dimensional stability at temperature extremes, excellent moldability, and impact strength make them extremely useful to the automotive industry. Closure manufacturers find the eye-appealing, non-bleeding finish of molded Durez to be the answer to

their materials problems. Time and again the versatility of the more than 300 Durez phenolic molding compounds has provided the solution to the materials problems of the imaginative design engineer.

Competent Assistance Available

The Durez laboratory technician is an experienced man. Years of successful development work and the continuing leadership of Durez phenolic plastics attest this. Your custom molder is also an experienced man. Many new molding methods and processes make his service even more valuable than before. Put these two men together and you'll stand an excellent chance of coming up with the answer to any practical plastic materials problem which you may have. The services of the Durez staff are available at all times to you and your custom molder. Durez Plastics & Chemicals, Inc., 3212 Walck Road, North Tonawanda, N. Y. Export Agents: Omni Products Corporation, 40 East 34th Street, New York 16, N. Y.

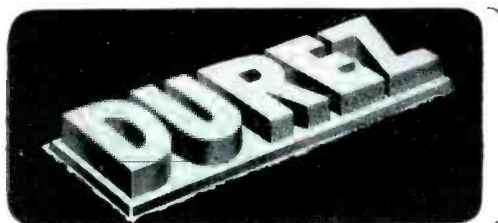

PHENOLIC
RESINS

MOLDING COMPOUNDS

INDUSTRIAL RESINS

OIL SOLUBLE RESINS

PLASTICS THAT FIT THE JOB



9 NEW RCA MINIATURES!

INCLUDES NEW COMPACT TYPES FOR AM, FM, AND TELEVISION RECEIVERS

• Here it is—that latest addition to the peacetime line of miniatures . . . 5 new miniature types that provide performance equivalents for the popular prewar kit 12SA7, 12SQ7, 12SK7 (or 12SG7), 35Z5GT/G, and 50L6GT—and 4 other tubes introduced as performance equivalents to the 6SA7, 6SG7, 6SQ7, and 6SH7.

These 9 new RCA miniatures bring to 35 the total number of tubes in the RCA miniature line—and all but 2 were developed by RCA engineers.

Such RCA pioneering means two important things to you:

1. That RCA knows your needs—keeps an eye on the industry—is ever striving to give you the tubes you want when you want them.
2. As the originator of miniatures and as the largest producer of them ever since their introduction, RCA can assure you of superior tube quality and uniformity at prices that are right.

For data on these 9 new tubes, send coupon.

If you are designing radio equipment and need tube-application assistance, don't forget that the RCA appli-

cation-engineering staff is always at your service for consultation. A telephone call to our nearest office, or a letter stating your problem, will do the trick. Address: Radio Corporation of America, Tube Division, Commercial Engineering Department, Section 62-41E, Harrison, N. J.

In Metals, Miniatures, or Glass Types . . .

THE FOUNTAINHEAD OF MODERN TUBE DEVELOPMENT IS RCA

AND HERE THEY ARE!

Miniatures New Types	DESCRIPTION	Performance Equivalent
★ 6AT6	Duplex-Diode High-Mu Triode	6SQ7
★ 6AU6	RF Amplifier Pentode with Sharp Cutoff	6SH7
★ 6BA6	RF Amplifier Pentode with Remote Cutoff	6SG7
★ 6BE6	Pentagrid Converter	6SA7
★ 12AT6	Duplex-Diode High-Mu Triode	12SQ7
★ 12BA6	RF Amplifier Pentode with Remote Cutoff	12SG7 (or 12SK7)
★ 12BE6	Pentagrid Converter	12SA7
★ 35W4	Half-wave High-Vacuum Rectifier	35Z5GT/G
★ 50B5	Beam-Power Amplifier	50L6GT

MAIL THIS TODAY FOR FREE DATA SHEETS

RCA, Commercial Engineering Department,
Section 62-41E, Harrison, N. J.

I'd like all the data available on the 9 new RCA miniatures announced in your December advertisement. Please rush me a complete set of data sheets, including ratings, curves, drawings, etc.

Name.....

Position.....

Company.....

Address.....

City..... Zone..... State.....



62-6126-41

RADIO CORPORATION OF AMERICA

TUBE DIVISION - HARRISON, N. J.

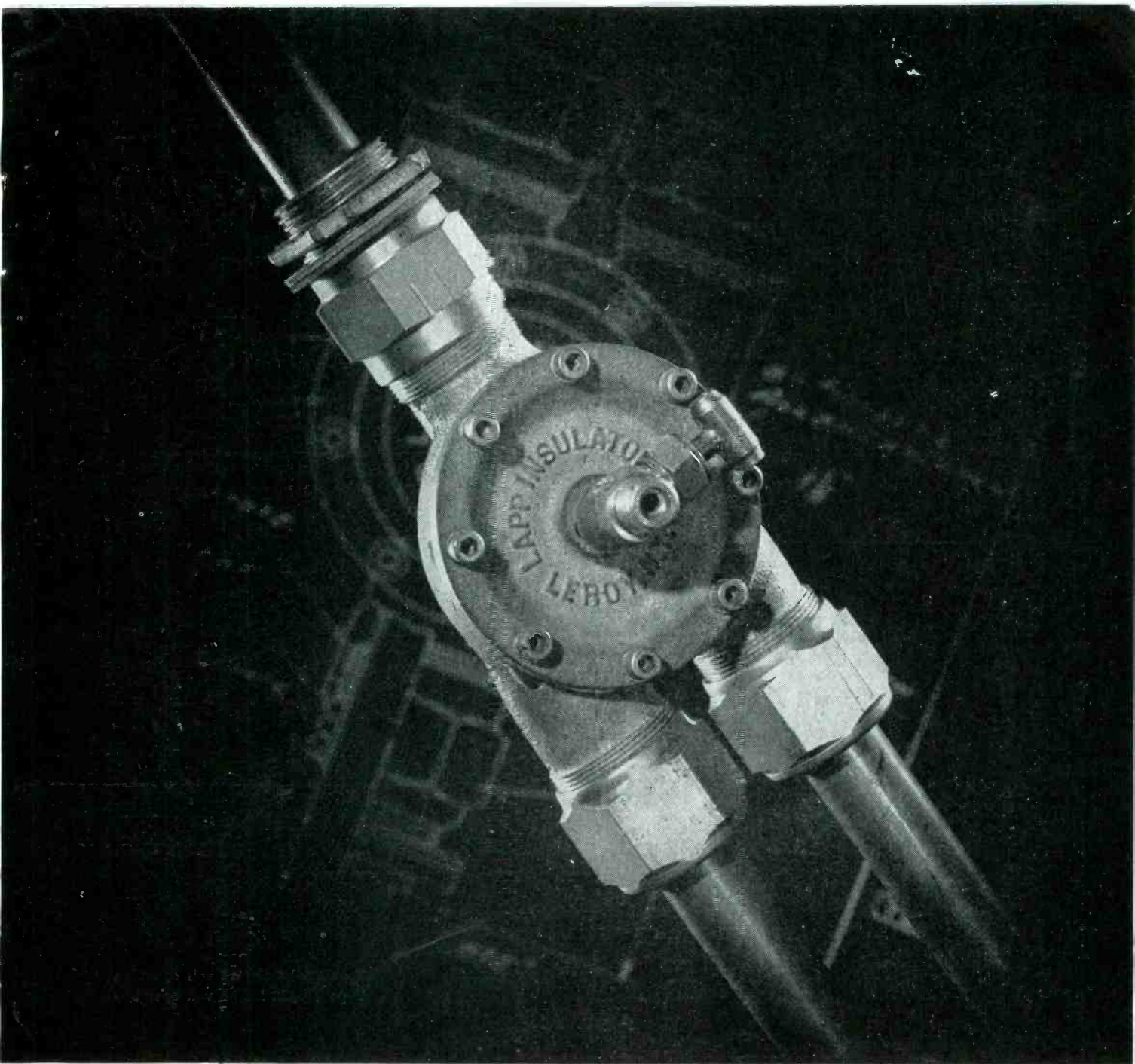

ENGINEERING AND PRODUCTION

The gadget above is a junction box for a co-axial gas-filled transmission line. It is one of a series of coupling units, end seals and other fittings for high-frequency transmission—designed and built by Lapp.

To this type of construction, Lapp brings several innovations and improvements. For example, such a line from Lapp parts is genuinely leak-proof. Every gasket is under spring loading, so there's no leakage created by vibration or thermal change.

Whether or not you're interested in gas-filled transmission lines, you ought to know about Lapp. Here is an organization of engineers and manufacturers with broad basic knowledge of ceramics and their application. With experience in hundreds upon hundreds of special-purpose electronic parts, we have been able countless times to improve performance, or reduce costs, or cut production time through

the application of our specialized skills to design and manufacture of parts involving porcelain or steatite and associated metal parts.

For quick and efficient assistance on a war production subcontract—or for the competitive advantage Lapp-designed and Lapp-built parts will give to you in the postwar battle—an inquiry to Lapp now may pay you dividends. *Lapp Insulator Co., Inc., LeRoy, N. Y.*



SPLITS SECONDS "just so"

THE W&T CONSTANT SPEED MOTOR MECHANISM meets precision standards

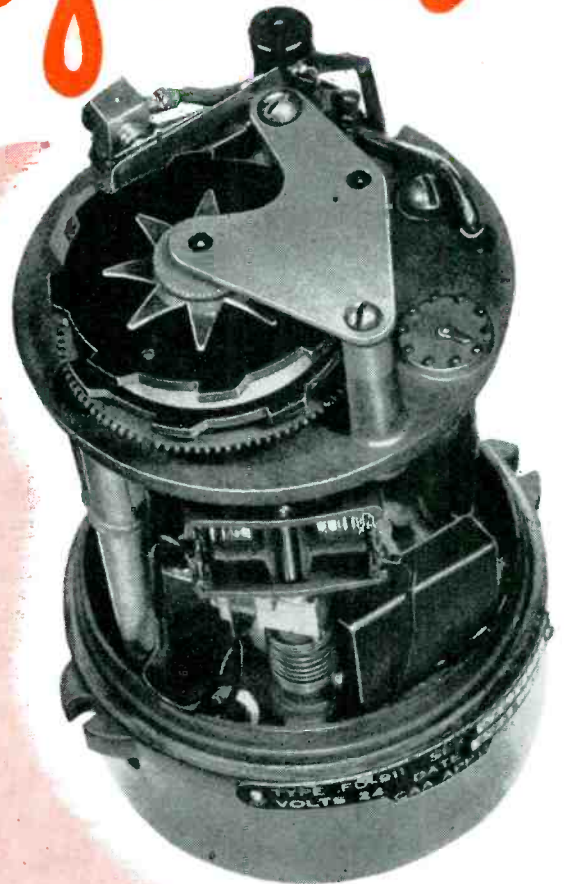

Type FA-121 for 12 volt operation
Type FA-122 for 24 volt operation

FOR coding, keying, monitoring, programming, or other timing applications this instrument, operating at a constant speed, regardless of voltage variations as great as $\pm 20\%$, permits accurate timing to hundredths of a second.

With a current input of only 0.003 milliamperes, the motor delivers 1800 gram inches per minute, a feature of especial importance in battery powered systems.

Interchangeable cams permit the use of any desired timing characteristic for two or more separate circuits.

Write for Technical Publication 234



WALLACE & TIERNAN PRODUCTS, INC.

BELLEVILLE 9 • NEW JERSEY



A 55

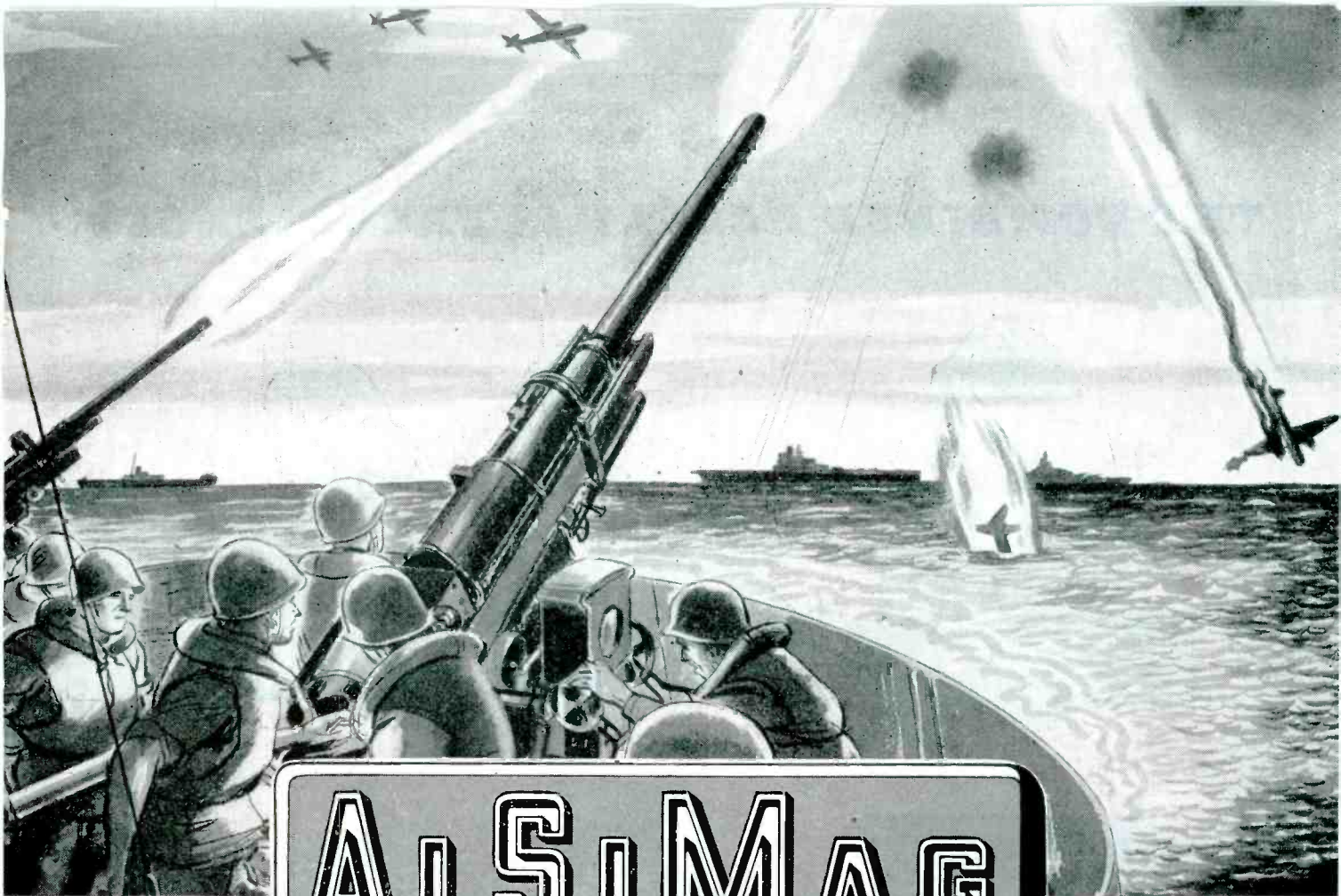

ALSiMAG

TRADE MARK REGISTERED U. S. PATENT OFFICE

CERAMICS
SO RUGGED THEY COULD WITHSTAND THE SHOCK
OF BEING FIRED FROM A GUN
WITH A FORCE OF
20,000g
in the
'RADIO PROXIMITY FUSE'
War's Number 2 Scientific Development

ALSiMAG Ceramic Insulators were extensively used in condensers for the 'Radio Proximity Fuse' described by high Navy officials as second only to the atomic bomb among the greatest scientific developments of the war.

Development of the fuse required production of electronic parts so rugged they could withstand the shock of being fired from a gun with a force 20,000 times that of gravity. The components had to be so small that a

complete unit could be installed in the nose of a projectile.

The fuse, developed at a cost of \$800,000,000 is an extremely rugged, five tube radio sending and receiving station which fits into the nose of a projectile. Reflected impulses explode the projectile when it passes within 70 feet of enemy planes.

The 'Radio Proximity Fuse' was the effective answer to Japanese suicide plane attacks,

as well as buzz bomb attacks on London.

American Lava Corporation is justly proud of the fact that it was able to provide the Ceramic Insulators capable of withstanding the tremendous shock of being fired from a gun in the 'Radio Proximity Fuse.'

Whatever you are planning in the field of electronics, we believe our specialized knowledge, research and production facilities will prove helpful. Let's work together.



ALCO has been awarded for the fifth time the Army-Navy "E" Award for continued excellence in quantity and quality of essential war production.

AMERICAN LAVA CORPORATION
CHATTANOOGA 5, TENNESSEE

43RD YEAR OF CERAMIC LEADERSHIP

www.americanradiohistory.com

THE COMBINED RESULT IS EXCELLENCE. . .



1 MICA SPLITTING



2 MICA GAUGING



3 MICA PUNCHING



5 CAPACITOR ASSEMBLY



6 HAND STACKING



7 CHECKING CAPACITANCE

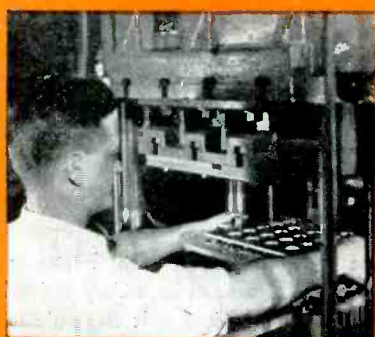

9 CAPACITOR MOULDING



10 CLEANING & INSPECTING

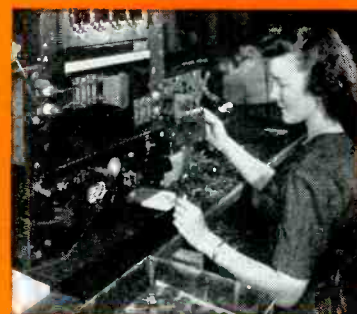

11 FINAL TESTING

SANGAMO ELECTRIC

ESTABLISHED 1898 . . . MICA CAPACITORS . . .

• IN Sangamo

MICA CAPACITORS

In our series of advertisements just completed, we have attempted to show "How Excellence is built into Sangamo Mica Capacitors" through featuring one department or process each month.

This review, depicting the various steps in the manufacture of a mica capacitor is a reminder of how important the SANGAMO MICA CAPACITOR production set-up is to you in the matter of quality control from the first operation—MICA SPLITTING—all the way through to the final operation—FINAL TESTING.

WRITE FOR
Catalog

As a user of MICA CAPACITORS, you will want to have the story of SANGAMO EXCELLENCE for reference. Therefore, we have bound the entire series of advertisements featuring the departments shown here, into a booklet. Simply write and ask for your copy of the booklet "HOW EXCELLENCE is built into SANGAMO MICA CAPACITORS."



4 MICA INSPECTION



CARTRIDGE IMPREGNATION



2 RESEARCH & ENGINEERING

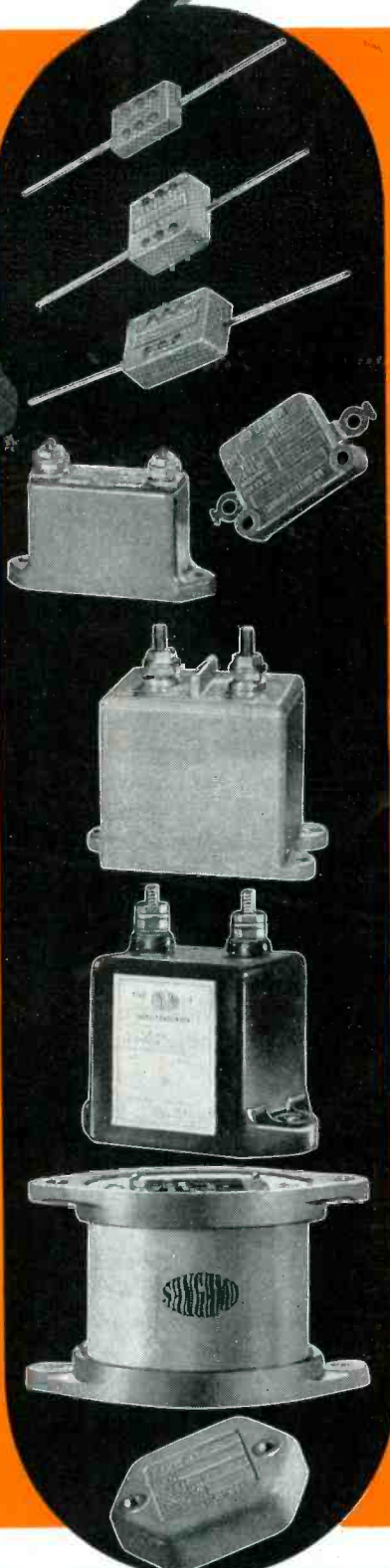

COMPANY SPRINGFIELD ILLINOIS

• • WATT HOUR METERS • • • TIME SWITCHES • • •

**DIRECT-VIEWING TELEVISION
RECEPTION AT ITS BEST, SPELLS...**

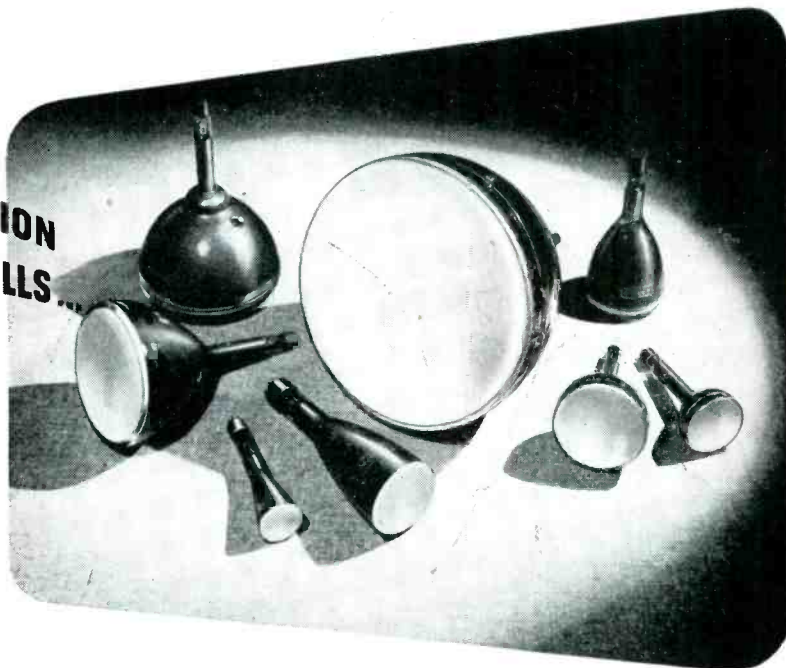

Du MONT

TELETRONS*

WHY DIRECT-VIEWING TELEVISION RECEPTION?

Because . . .

- Excellent pictorial resolution due to minimum spot size.
- Higher brilliance and better contrast range for vivid pictures.
- Wide-angle viewing, accommodating the largest audience for given screen size.
- Lower accelerating voltage, which means less costly receiver power supply.
- Simplicity of the focusing system, since it is entirely electronic.
- Longer tube life and therefore lower operating cost.
- Previous objections to curvature of face have been overcome by design of essentially flat-faced bulbs.
- DuMont offers the larger image tubes for adequate screen sizes and the greatest receiver value.

REG. TRADE-MARK

► It's *all in the tube* when dealing with direct-viewing television reception. The image is viewed directly as scanned. No mirrors or lenses; no dust or dirt to dim the image; no realignments ever required. The complete device for image reproduction is *permanently set and sealed at the plant.*

DuMont has led in the development and production of large-image cathode-ray tubes for television (Teletrons) in all sizes and types.

DuMont Teletrons make direct-viewing practical, logical, and truly economical.

► *Interested? Our engineers are ready to collaborate in fitting the right Teletron to your particular problem. Technical data on request.*

Remember, DuMONT also makes other types of cathode-ray tubes, oscillographs, television receivers and television transmitting equipment.

© ALLEN B. DUMONT LABORATORIES, INC.

DUMONT *Precision Electronics & Television*
 ALLEN B. DUMONT LABORATORIES, INC., PASSAIC, NEW JERSEY • CABLE ADDRESS: ALBEEDU, PASSAIC, N. J., U. S. A.

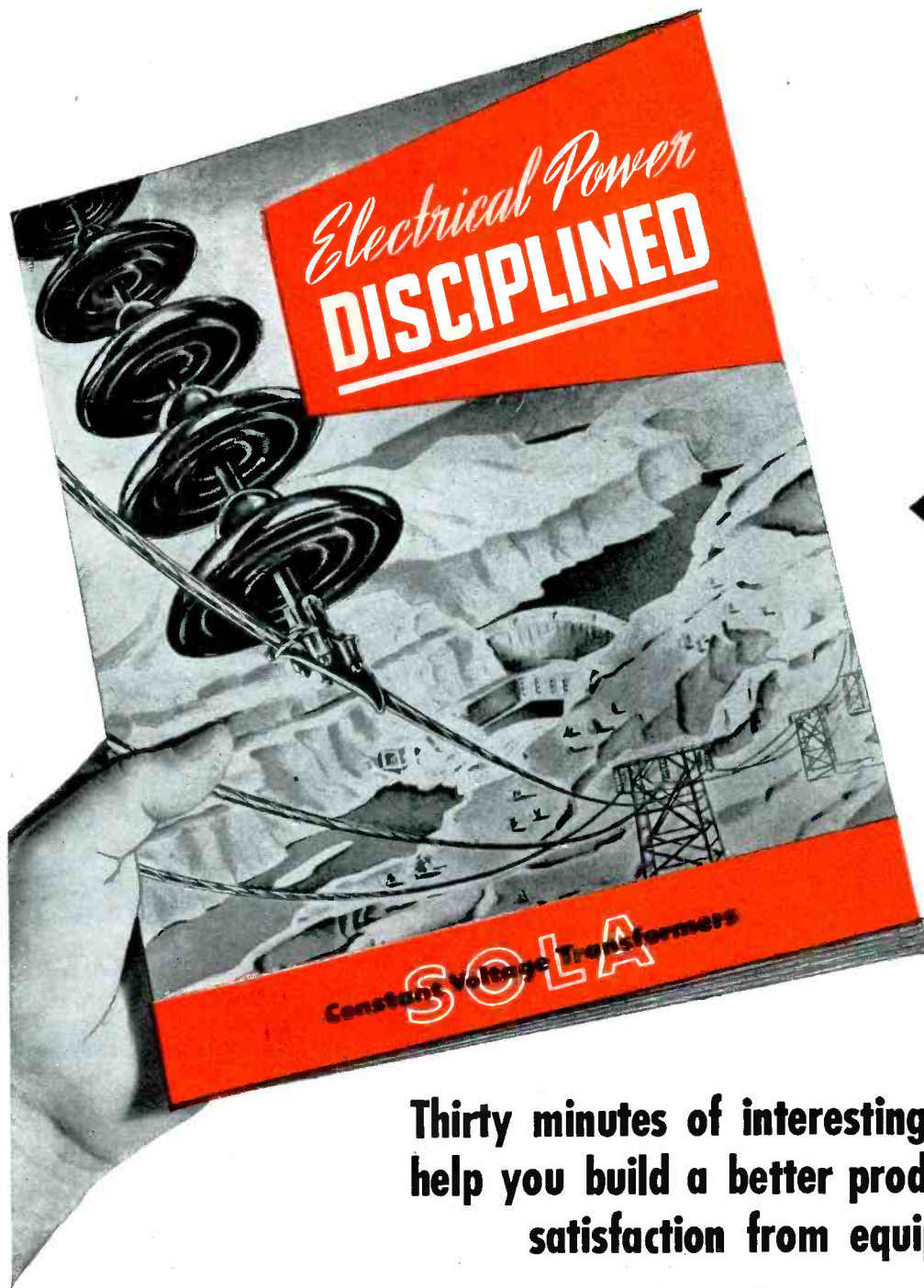

for:

designers

manufacturers

**maintenance
engineers**

salesmen

**users of
electronic and
electrically
operated
equipment**

Thirty minutes of interesting reading that will help you build a better product or get greater satisfaction from equipment now in use

What is a Constant Voltage Transformer?—why is it necessary?—how does it operate?—where can it be used?—what new developments have resulted from its world-wide, war-time use?—

... these and many other important questions are fully answered in this new SOLA handbook.

The Constant Voltage Transform-

mer is an exclusive SOLA product—the ONLY voltage regulating TRANSFORMER. In principle, design and construction it is different and should not be confused with ordinary types of voltage regulating networks.

It employs no tubes and has no moving parts. It is fully automatic in operation, it is not dependent on manual control or supervision and

protects both itself and the equipment it serves against voltage surges or short circuit. It instantly corrects voltage fluctuations as great as 30% to within $\pm 1\%$ of rated value.

Your product will serve more people—*better*—with built-in Constant Voltage. There are SOLA units specially designed for that purpose—fully described in this new handbook.

Constant Voltage Transformers
SOLA

Write for your copy

You will find in this handbook a final answer to the problem that confronts every manufacturer or user of electrically operated equipment.

Ask for Bulletin DCV-102

Transformers for: Constant Voltage • Cold Cathode Lighting • Mercury Lamps • Series Lighting • Fluorescent Lighting • X-Ray Equipment • Luminous Tube Signs • Oil Burner Ignition • Radio • Power • Controls • Signal Systems • etc. **SOLA ELECTRIC COMPANY, 2525 Clybourn Avenue, Chicago 14, Illinois**

Measuring SOUND

Why Western Electric equipment leads the way!

1. Western Electric products are designed by Bell Telephone Laboratories — world's largest organization devoted exclusively to research and development in all phases of electrical communication.

2. Since 1869, Western Electric has been the leading maker of communications apparatus. During the war this company was the nation's largest producer of electronic and communications equipment.

3. The outstanding quality of Western Electric equipment has been proved daily on land, at sea, in the air, under every extreme of climate. No other company supplied so much equipment of so many different kinds for military communications.

In flight tests at Wright Aeronautical, a Western Electric sound analyzer is used to measure sound characteristics of the plane and locate major sound disturbances.

Western Electric

Today's world is a world of sound. How different it would be without the telephone, radio, public address systems, aids for the hard of hearing, talking pictures!

For many years, Bell Telephone Laboratories and Western Electric — working closely as research and manufacturing teammates — have led the way in building this world of sound.

In the course of their sound-transmission work, these teammates

Western Electric has specialized

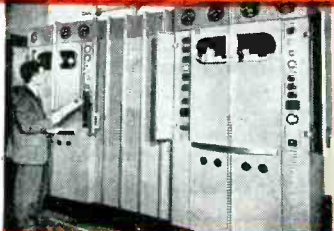

AM • BROADCASTING • FM



TELEVISION



AVIATION RADIO



MARINE RADIO

or spreading it around



A powerful Western Electric public address system spreads sound evenly throughout New York's huge Madison Square Garden which seats more than 18,000 people.

equipment leads the way!

have also developed scientifically accurate instruments for *measuring* and *analyzing* sound and vibration. These instruments have many important uses today — will have still more tomorrow.

Through their lifetime of pioneering in this field, Bell Labs and Western Electric have gained a unique knowledge of sound and how to handle it. Count on them for the finest equipment for measuring sound or spreading it around!



Buy all the Victory Bonds you can
. . . and keep all you buy!

knowledge in all of these fields



MOBILE RADIO



HEARING AIDS



SOUND MOTION PICTURES



VACUUM TUBES

How **KARP** cuts costs on sheet metal fabrication

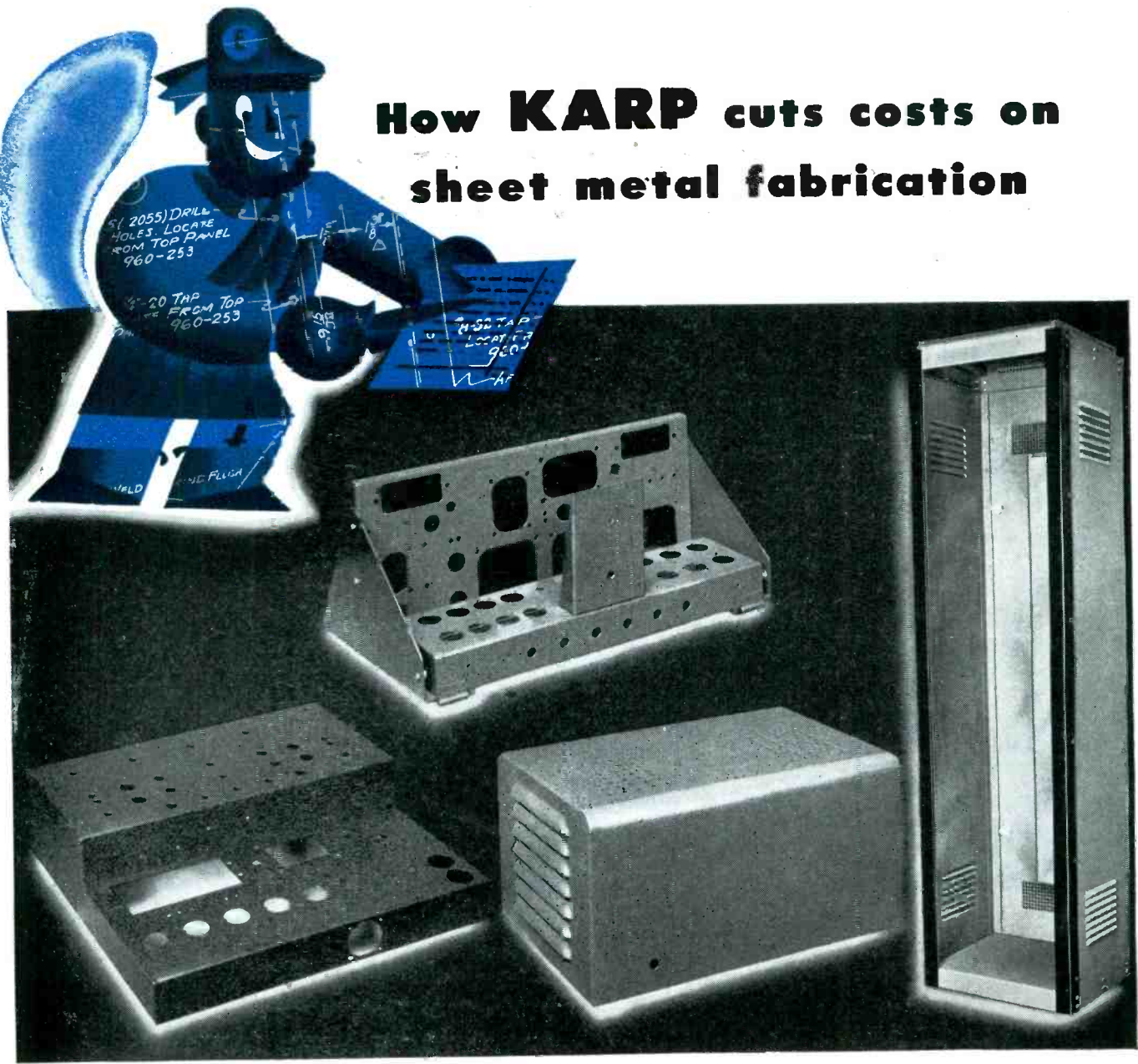

Every job we do is a special-built job, individualized to exact specifications. Yet our superior machine installations and vast stocks of dies and jigs permit us to fabricate your order economically and with precision—frequently saving you the cost of special dies.

Since 1925, our specialty has been the fabrication of cabinets, housings, chassis and enclosures for electronic, electrical and mechanical apparatus. Prior to and during the war, we continued and intensified

this specialty, and shall now continue it in peace. Therefore, we are not reconverting to any other line. We are not a "war baby"—but our wartime experience has added to our facilities and abilities.

Tell us your sheet metal fabrication needs. We can serve you with satisfaction and speed. More often than not, we can save you money, too.



**ANY METAL • ANY SIZE
ANY GAUGE • ANY FINISH**

KARP METAL PRODUCTS CO., INC.

124-30th Street, Brooklyn 32, N. Y.

Custom Craftsmen in Sheet Metal



READY TO SERVE YOU AGAIN!

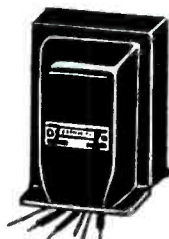

Thordarson has returned from the war and is ready now to serve its many customers. *Thordarson* regrets there has been an interruption in service performance to regular customers and that orders could not be filled during the war. Here's the reason.

The superior quality of *Thordarson* transformers and other electronic devices was recognized immediately by Uncle Sam at the outbreak of the war and *Thordarson* production (100%) was required to fill all-important government orders.

Now the same high quality that was so acceptable in the recent emergency is available to you. *Thordarson* transformers—always the gauge of superior quality and unexcelled performance—are now even better because of many new additions and developments made during the war. *Thordarson* research-engineering plus *Thordarson* quality team together in the production of better equipment and devices for the electronics industry.

New distribution policies and sales promotion plans make *Thordarson* products and complete informative data on their application and use available to all customers—everywhere!

ALWAYS THINK OF THORDARSON FOR TOP-NOTCH TRANSFORMERS!

500 WEST HURON ST., CHICAGO, ILL.

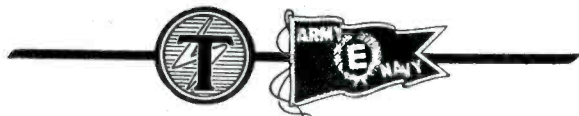

ORIGINATORS OF TRU-FIDELITY AMPLIFIERS

THORDARSON

ELECTRIC MANUFACTURING DIVISION

MAGUIRE INDUSTRIES, INCORPORATED

SMALL SPACE
LONG LIFE
MOISTUREPROOF
HEATPROOF

DUMONT
 PAPER
CAPACITORS
TYPE P6



**DUMONT RESINOID
 SEALED • WILL NOT
 MELT AT 300° F**

**NO AIR VOIDS
 FILLED UNDER VACUUM**

CAT. NO.	CAPACITY MFD	200 V.D.C. SIZES DXL	400 V.D.C. SIZES DXL	600 V.D.C. SIZES DXL	1000 V.D.C. SIZES DXL
P6-1	.001	3/8 X 1"	3/8 X 1"	3/8 X 1"	3/8 X 1 1/4"
P6-2	.002	3/8 X 1"	3/8 X 1"	3/8 X 1"	3/8 X 1 1/4"
P6-3	.003	3/8 X 1"	3/8 X 1"	3/8 X 1"	3/8 X 1 1/4"
P6-4	.004	3/8 X 1"	3/8 X 1"	3/8 X 1"	3/8 X 1 1/4"
P6-5	.005	3/8 X 1"	3/8 X 1"	7/16 X 1"	3/8 X 1 1/4"
P6-6	.006	3/8 X 1"	3/8 X 1"	7/16 X 1"	3/8 X 1 1/4"
P6-7	.008	3/8 X 1"	3/8 X 1"	7/16 X 1"	3/8 X 1 1/4"
P6-8	.01	3/8 X 1"	3/8 X 1"	7/16 X 1"	3/8 X 1 1/4"
P6-9	.02	3/8 X 1"	3/8 X 1"	7/16 X 1"	3/8 X 1 1/2"
P6-10	.03	3/8 X 1"	3/8 X 1 3/8"	1/2 X 1 1/2"	3/8 X 1 1/2"
P6-11	.05	7/16 X 1 3/8"	1/2 X 1 3/8"	1/2 X 1 1/2"	3/8 X 2"
P6-12	.1	7/16 X 1 3/8"	5/8 X 1 3/8"	5/8 X 2"	3/4 X 2"
P6-13	.25	5/8 X 1 3/8"	3/4 X 1 3/8"	3/4 X 2 1/2"	7/8 X 2 1/2"
P6-14	.5	3/4 X 1 3/8"	7/8 X 1 3/8"	3/4 X 2 1/2"	1 X 2 1/2"

Also made
 in 1600 and
 2000 volts
 SIZES ± 1/32"

DUMONT
ELECTRIC CO.
 MFR'S OF
 CAPACITORS FOR EVERY REQUIREMENT
 34 HUBERT STREET NEW YORK, N. Y.

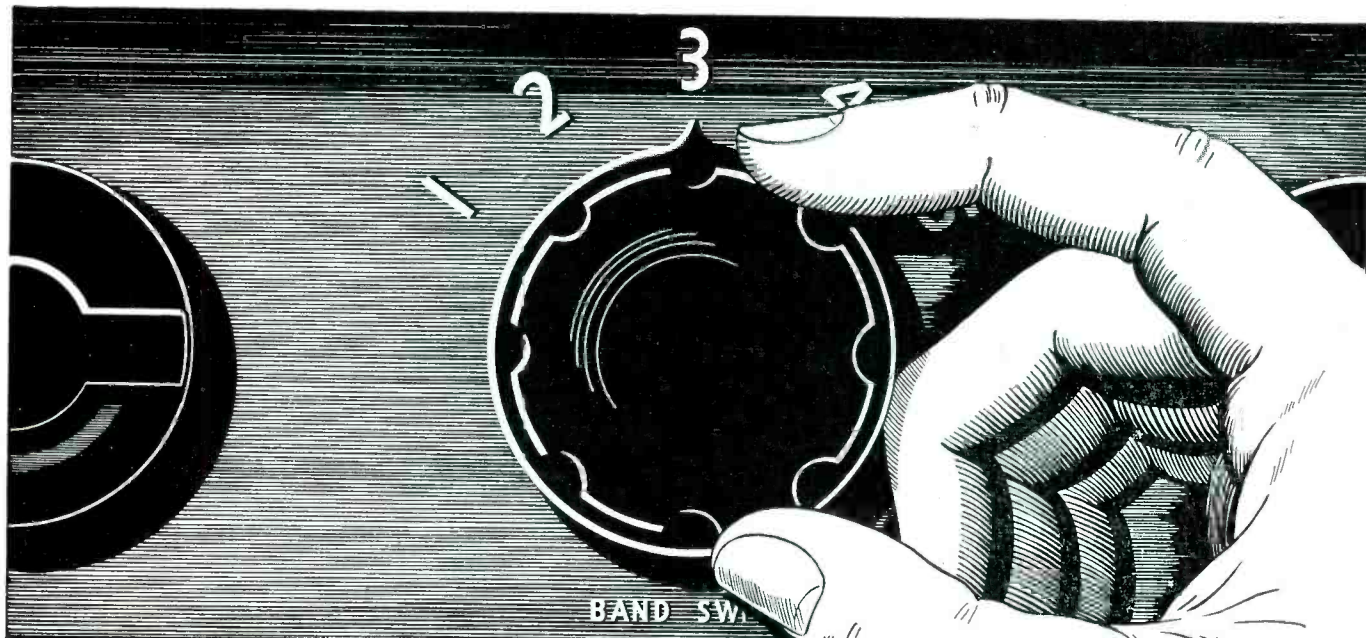

For easier bandswitching use the 257B Gammatron!

The HK-257B beam pentode, originated by Heintz and Kaufman engineers, facilitates the design, construction, and operation of multi-band transmitters since it requires very little driving power and no neutralization.

The wiring diagram below shows a transmitter capable of operating on all amateur bands from 10 to 160 meters. A single 6V6 metal tube in the oscillator circuit drives the r.f. amplifier to its full output. The precise internal shielding of the HK-257B makes neutralization unnecessary.

Write today for complete data on the 257B Gammatron, a versatile tube capable of very high frequency operation.

HEINTZ AND KAUFMAN LTD.

SOUTH SAN FRANCISCO • CALIFORNIA



Export Agents: M. Simon and Son Co., Inc.
25 Warren Street • New York City

KEEP IT UP... BUY WAR BONDS

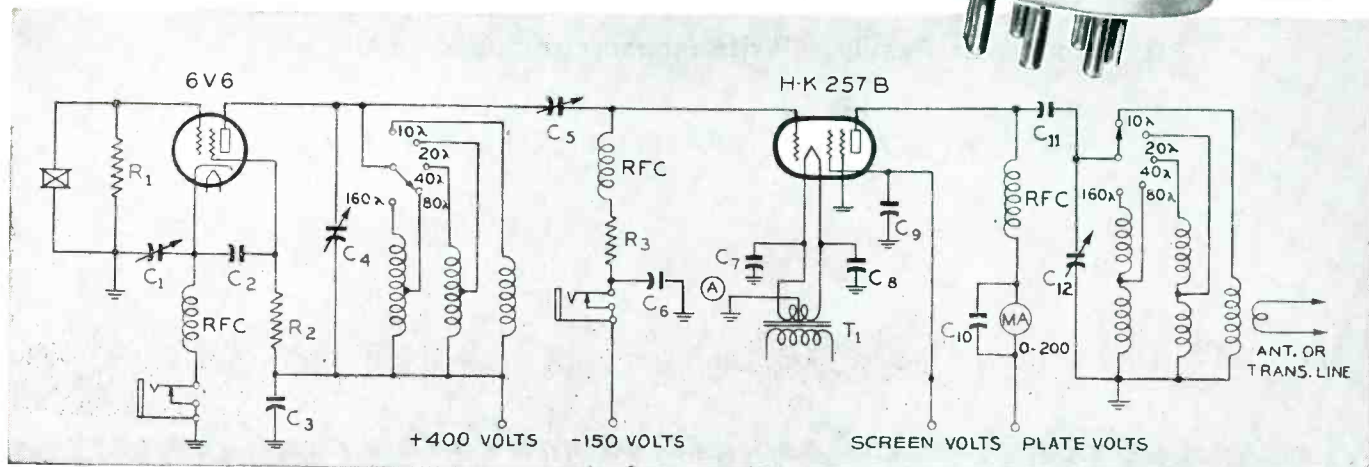
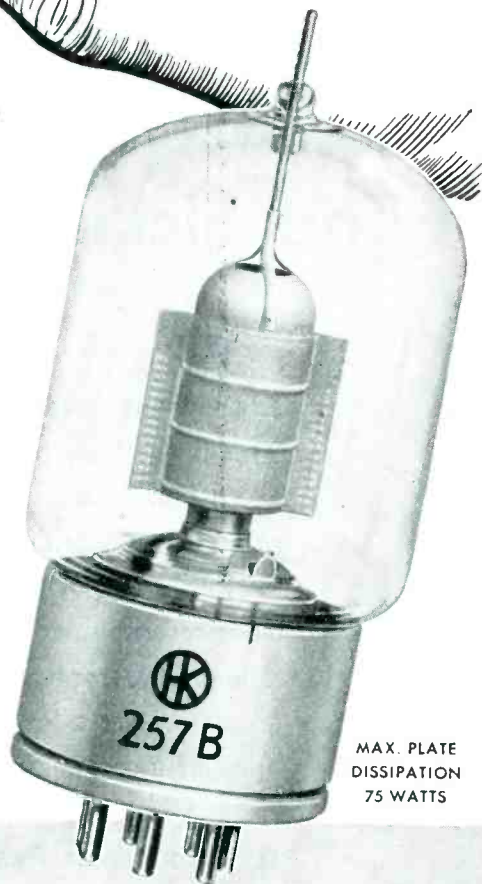

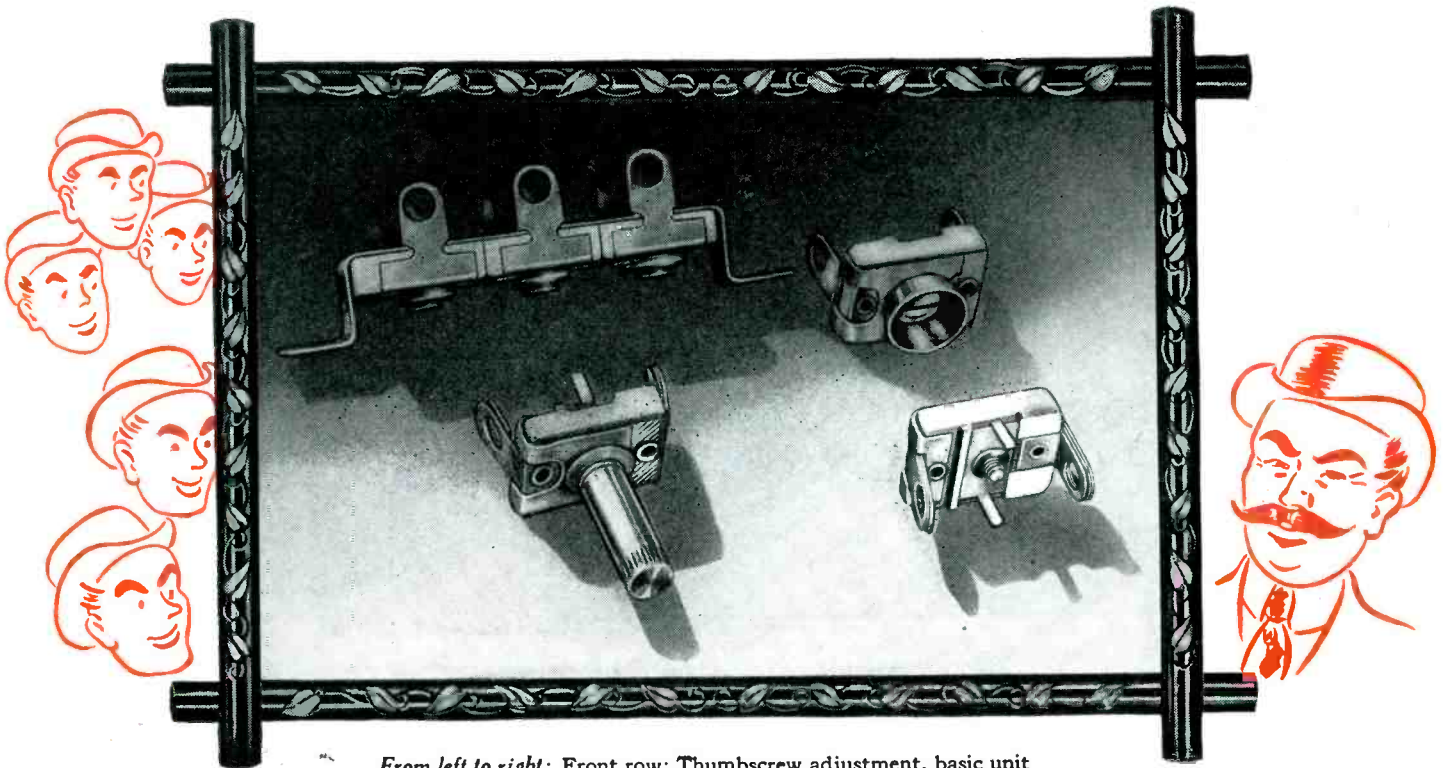

From left to right: Front row: Thumbscrew adjustment, basic unit
Back Row: Multiplicity of brackets, guide cup

The Sickles' ILC Condenser Family

Just like their Dad . . . only more so

In the front row is the "Poppa" of the ILC Sickles' Condenser family. This is the basic unit from which all other ILC's are adapted.

This basic unit is available in six different ranges. It is possible to add silvered mica for increased stability (at some sacrifice of range).

Note a few of the ILC offsprings in the picture above. See their close resemblance to their "Dad." Yet they all have special features. The one in front at left has a thumbscrew adjustment, the one behind it has brackets for as many ILC's in a unit as desired, and the other one has a screw guide cup.

Many different special features are found on other members of the ILC Condenser Family. Write for more complete details.

THE F. W. SICKLES COMPANY • CHICOPEE, MASS.

SICKLES

Radio and Electronic Specialties for Today and Tomorrow

In Springs—

it's the X-Dimension that gives a Glider and You a Lift

Ever hear of the X-Dimension of a Spring? Probably not. But, sure as you're born it's there, in every spring. Take, for instance, the intriguing what-is-it pictured below. It's a glider release spring, an assembly which holds the pick-up rope until the parent plane hitches on—then let's go at a precise jerk on the towline.

If Hunter had only manufactured and delivered dependable glider release springs on time and in needed quantities, its job would have been

satisfactory. But Hunter invented the device for All American Aviation, Inc., and assigned the patents to them. That's the X-Dimension at work.

It's also at work in such pioneering efforts in spring manufacture as control gaging and statistical methods in quality control. It's your guarantee of good springs, your insurance against failures, and customer complaints. It's *more* than you bargained for—in springs.



HUNTER PRESSED STEEL COMPANY
Lansdale, Pennsylvania
SPRINGS • METAL STAMPINGS • WIRE FORMS
MECHANICAL AND ELECTRICAL ASSEMBLIES

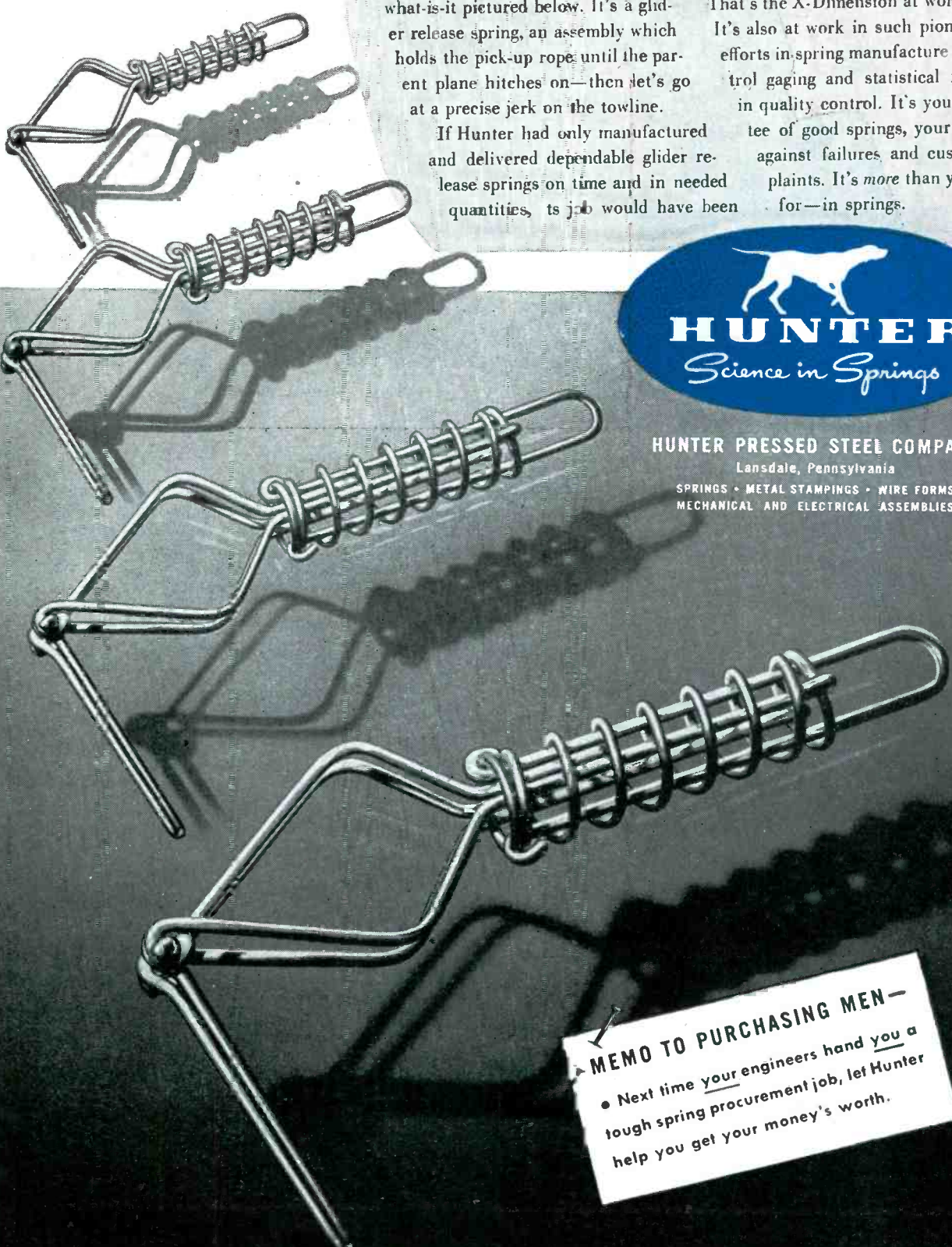

MEMO TO PURCHASING MEN—
• Next time your engineers hand you a tough spring procurement job, let Hunter help you get your money's worth.

Announcing **RCA-6C24**

1100 WATTS OUTPUT AT 160 MEGACYCLES!

PRICE
\$45⁰⁰



Keep
Buying
Bonds

TECHNICAL DATA

Filament Voltage (A.C.), volts	11.0
Filament Current, amperes	12.1
Amplification Factor	30
Direct Interelectrode Capacitances, micromicrofarads	
grid-to-plate	4.4
grid-to-filament	4.6
plate-to-filament	3.2
Overall length (less lead wires), inches	6 1/8"
Max. diameter, inches	1 7/8"

Typical Operation at Maximum Plate Volts

	Class B* Audio Amplifier or Modulator	Class B Telephone R.F. Amplifier	Plate- Modulated Class C Telephons	Class C Telegraph
Plate Volts	3000	3000	2500	3000
Plate Milliampères	800#	200	400	500
Driving Power (Approx.) Watts	30#	16	75	75
Power Output (Approx.) Watts	1600#	200	800	1100

*Two tubes #At max. signal

Here's a tube that fills that important need for medium power in the new FM and television bands—a compact and efficient tube for commercial, emergency, government, and industrial service, in the frequency range above that of the popular RCA-833A.

The 6C24 is a triode having low interelectrode capacitances and low lead inductance for high-frequency applications. Forced-air cooling of the sturdy copper radiators results in a simple and convenient system.

The 6C24 is designed for either fixed or portable operation. Takes full input up to 160 megacycles.

Industrial Applications

The 6C24 is rated at both 400 and 600 watts

plate dissipation. This higher rating requires increased air flow, but is of particular interest to designers of electronic heating equipment in which it is desired to hold tube and circuit conditions to moderately low efficiencies for conservative operation of the 6C24.

Application Assistance

If you have an application for the 6C24, or for other RCA tubes, and would like the assistance of our application engineers, please write, stating your problem. For technical bulletin on the 6C24, send the coupon for complete technical data, curves, drawings, and application hints. Address: Radio Corporation of America, Tube Division, Commercial Engineering Department, Section 62-102E, Harrison, New Jersey.

The Fountainhead of Modern Tube Development Is RCA

—Send Coupon Now for Free Technical Bulletin—

RCA, COMMERCIAL ENGINEERING DEPARTMENT
Section 62-102E, Harrison, N. J.

Please send me free bulletin on the RCA-6C24 triode giving complete technical data, drawings, curves, and application hints.

Name.....
Position.....
Company.....
Address.....
City..... Zone..... State.....



Now RCA Offers a
Complete Line of
Dry Batteries, Too

62-6536-102

**RADIO CORPORATION
OF AMERICA**

TUBE DIVISION · HARRISON, N. J.

A STANDARD RELAY FOR DOZENS OF SPECIAL APPLICATIONS

... requiring a compact light weight unit that handles plenty of power and is highly resistant to shock and vibration

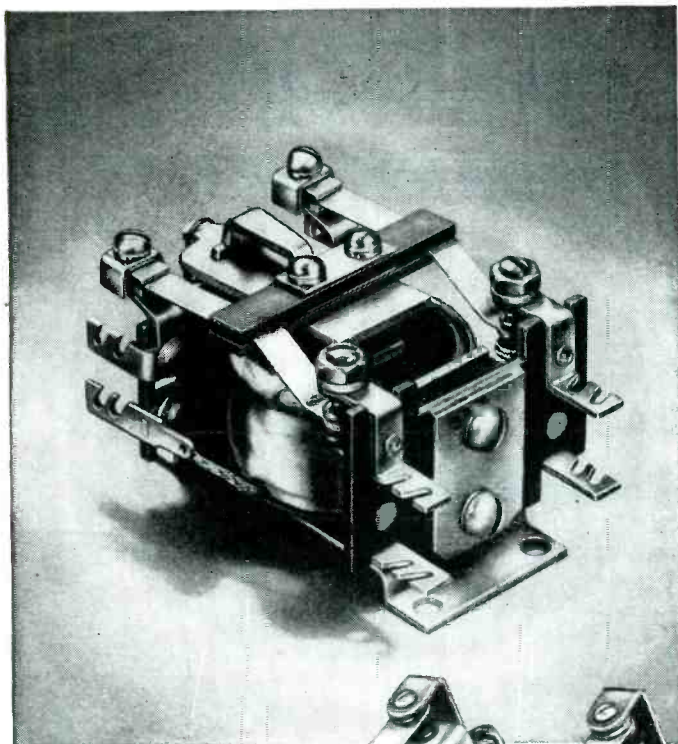

The design flexibility of Struthers-Dunn 10 Frame a-c and d-c relays coupled with their proven dependability under adverse operating conditions make them ideal for many applications usually requiring more costly special types. 10 Frame Relays are small and light and particularly built to withstand shock and continuous vibration.

Features include: — One- to four-pole, single- and double-throw contact arrangements; insulations suitable for power or radio-frequency circuits; high contact pressures and plenty of "follow-up" for long contact life.

Struthers-Dunn #10 Frame Relays are currently used in many Radar, Radio, and Communications circuits for shipboard, aircraft and general use, including a wide variety of industrial installations requiring extra quality and plus performance. Write for Data Sheet 10-000 describing the 10-Frame Relay Series and outlining a few of the many available modifications.

STRUTHERS-DUNN, Inc.
1321 Arch Street, Phila. 7, Pa.

▲ **TYPE 10XBX**—Two-pole, double-throw contacts, featuring phenolic insulation, metal base, and solder terminals.

▶ Modified 10 Frame construction Type 10XBX117 for R-F application. Features include bonded mica insulation and binding post type terminals.

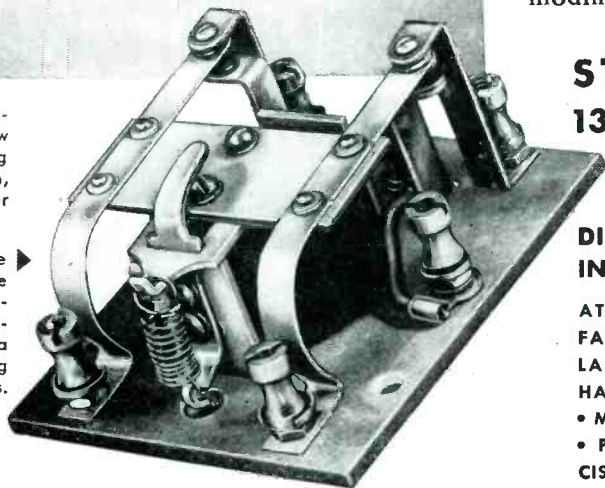

DISTRICT ENGINEERING OFFICES IN THESE CITIES TO SERVE YOU:

ATLANTA • BALTIMORE • BOSTON • BUFFALO • CHICAGO • CINCINNATI • CLEVELAND • DALLAS • DENVER • DETROIT • HARTFORD • INDIANAPOLIS • LOS ANGELES • MINNEAPOLIS • MONTREAL • NEW YORK • PITTSBURGH • ST. LOUIS • SAN FRANCISCO • SEATTLE • SYRACUSE • TORONTO



STRUTHERS-DUNN

5,312 RELAY TYPES

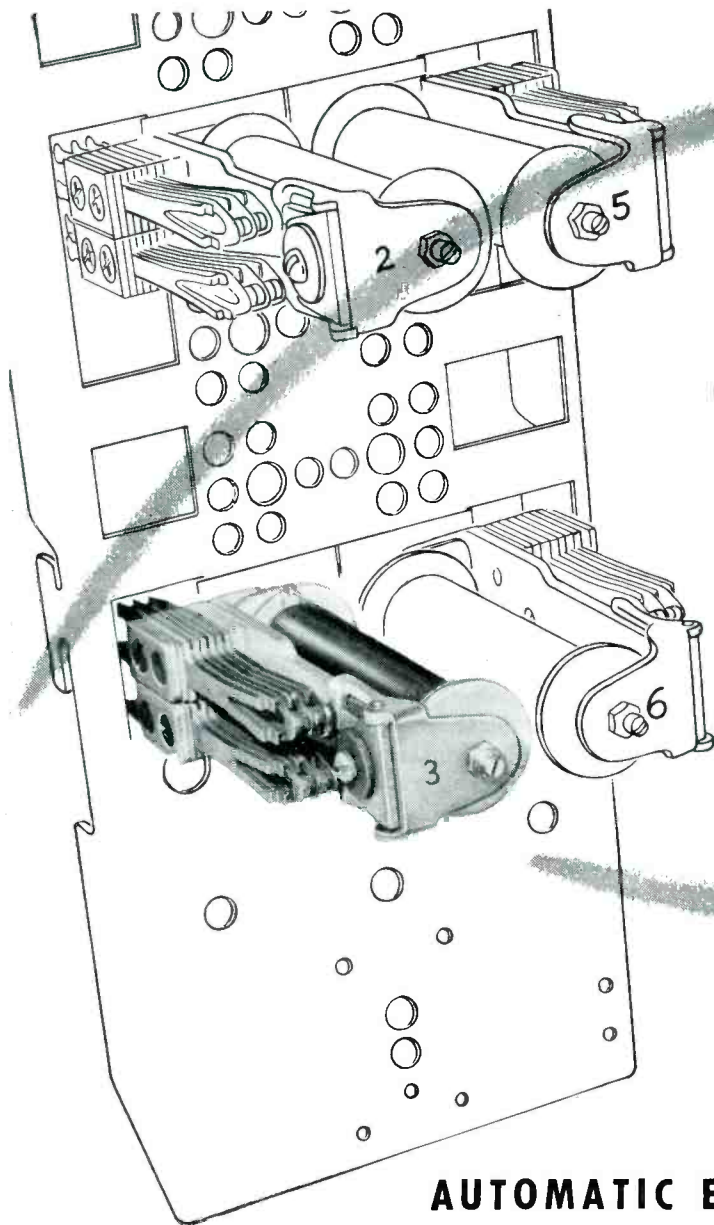

More

**THAN 300,000,000
OPERATIONS**

AUTOMATIC ELECTRIC'S CLASS "B" RELAY

Want real proof of relay ruggedness? Many months ago, several Class "B" relays, taken from regular production, were placed on "life test." Today, with no attention except for occasional lubrication, they are still functioning satisfactorily—and every one has hung up the amazing record of more than 300,000,000 operations! For ruggedness—for all the other features you need, specify Automatic Electric's Class "B" relays.

Independent twin contacts for dependable contact closure... efficient magnetic circuit for sensitivity and high contact pressure... unique armature bearing for long wear under severe conditions... compact

design for important savings in space and weight. Now available for coil voltages to 300 volts DC and 230 volts AC, with capacities up to 28 springs; also with magnetic shielding cover, when specified.

The Class "B" relay, and many others, are shown in Catalog 4071. Write today for your copy.

Relays by

AUTOMATIC  ELECTRIC

AUTOMATIC ELECTRIC SALES CORPORATION
1033 WEST VAN BUREN STREET • CHICAGO 7, ILLINOIS
In Canada: AUTOMATIC ELECTRIC (CANADA) LIMITED, TORONTO

PARTS AND ASSEMBLIES FOR EVERY ELECTRICAL CONTROL NEED

NEW RAYTHEON SUB-MINIATURE TUBES for Pocket Receivers

Since 1938 Raytheon has pioneered in the design, development and production of small, low drain, long life tubes. These have helped to make possible the modern extremely compact hearing aid.

Now for Radio Receivers—Now Raytheon announces a physically similar kit of flat style, sub-miniature tubes for radio receiver applications. Included is a shielded RF-pentode amplifier, a triode-heptode converter, a diode-pentode detector-amplifier and an output pentode for earphone operation.

Much Smaller Radios Possible—These tubes make it possible to construct radios a fraction the size of prewar "personals," with sensitivity rivaling much larger sets.

The ratio of performance to battery drain is maintained very high, thus assuring the maximum possible operating life from the small size batteries now available.

The line consists of tubes approximately $1\frac{1}{16}$ " long x 0.3" x 0.4" in cross section. Each type is available with pins for use with small commercially available sockets as illustrated, or may be had with long flexible leads for wiring the tube directly into the circuit.

No progressive radio manufacturer will overlook the tremendous possibilities inherent in the small pocket receiver—built around the new Raytheon sub-miniature tubes. But call on Raytheon for every tube need—large or small—for the finest in engineering, production and performance.

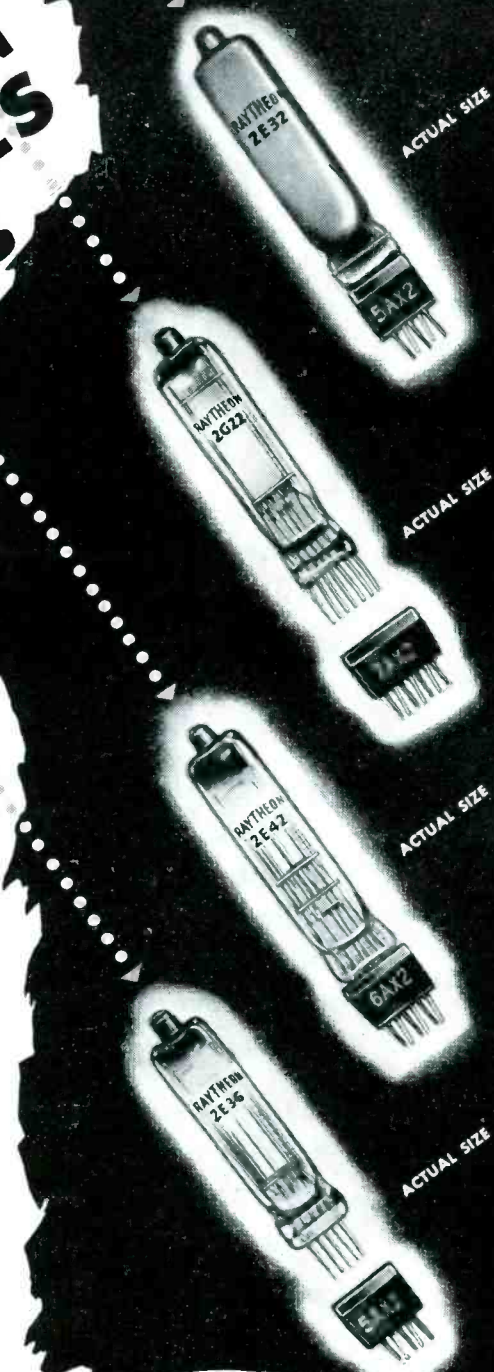

ELECTRICAL CHARACTERISTICS

	2E31† 2E32# Shielded RF Pentode	2G21† 2G22# Triode- Heptode	2E41† 2E42# Diode- Pentode	2E35† 2E36# Output Pentode
Filament Voltage	1.25 V	1.25 V	1.25 V	1.25 V
Filament Current	50 ma	50 ma	30 ma	30 ma
Max. Grid-Plate Capacitance	0.018 μf	0.065 μf‡	0.10 μf	0.2 μf
Plate Voltage**	22.5 V	22.5 V	22.5 V	22.5 V
Screen Voltage	22.5 V	22.5 V	22.5 V	22.5 V
Control Grid Voltage*	0	0	0	0
Osc. Plate Voltage	—	22.5 V	—	—
Plate Current	0.35 ma	0.2 ma	0.4 ma	0.27 ma
Screen Current	0.3 ma	0.3 ma	0.15 ma	0.07 ma
Osc. Plate Current	—	1.0 ma	—	—
Transconductance	500 μmhos	60 μmhos (Gc)	400 μmhos	385 μmhos
Plate Resistance	0.35 meg	0.5 meg##	0.25 meg	0.22 meg

*With 5 megohm grid resistance connected to F —.
**Higher voltage operation is possible as shown on engineering characteristics sheet available by request.

†Flexible lead Types.
#Plug-in Types.
##Approximate conversion Rp.
‡Signal grid to mixer plate Capacitance

RAYTHEON
MANUFACTURING COMPANY

Radio Receiving Tube Division
NEWTON, MASSACHUSETTS • LOS ANGELES
NEW YORK • CHICAGO • ATLANTA

EXCELLENCE IN ELECTRONICS

CINAUDAGRAPH

designed over 100 different
PERMANENT MAGNETS
FOR
RADAR

Many manufacturers shared in the development of Radar. Skilled scientists in many a research laboratory contributed to the perfection of this remarkably effective instrument for detecting, locating, and defining objects at a distance through fog or storm, in the night.

In every modern Radar Set a permanent magnet is an essential element. We, at Cinaudagraph, feel that it was distinctly a tribute to the skill of our engineers and workmen that we were called upon to design and manufacture a large portion of the permanent magnets for all the Radar Sets. Our engineers designed over 100 different types of magnets, and tens of thousands of these were manufactured in our plant.

In the rapidly developing field of electronics, the permanent magnet is bound to play an important part. Our engineering department will be glad to help on magnet problems in connection with any apparatus or instrument you are planning to produce.

Send for our pamphlet, "Permanent Magnet Design"

2 SELLECK ST.

**CINAUDAGRAPH
CORPORATION**

STAMFORD, CONN.

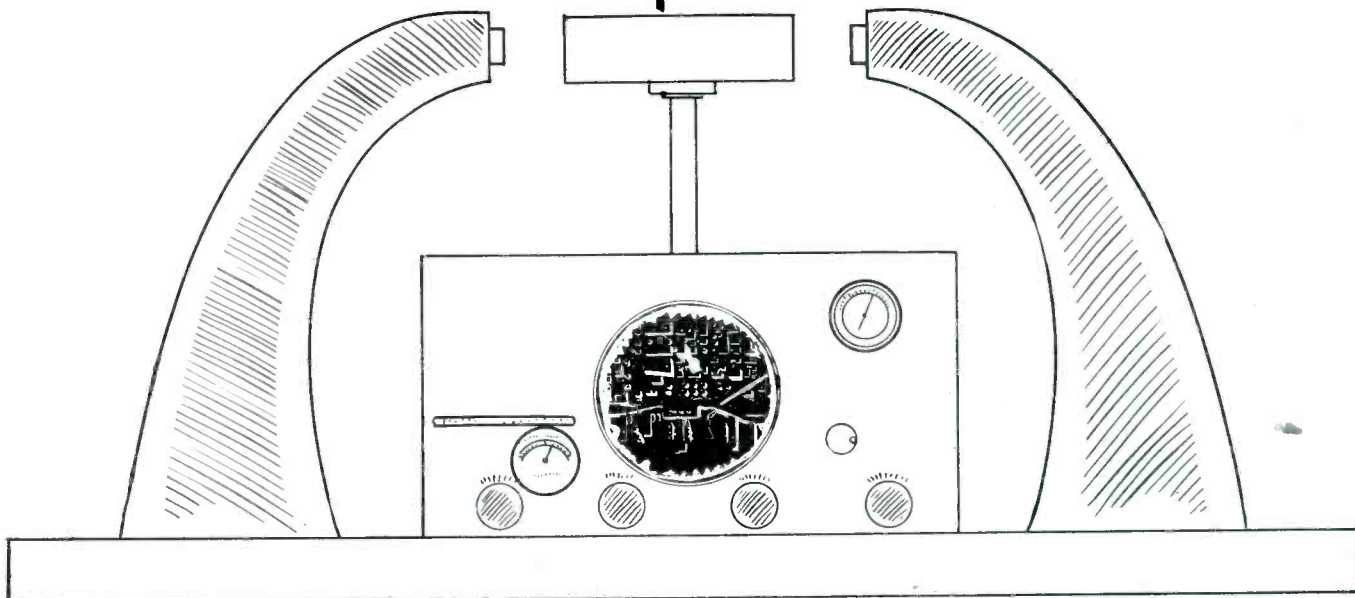
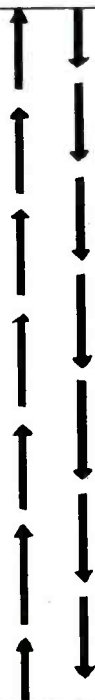
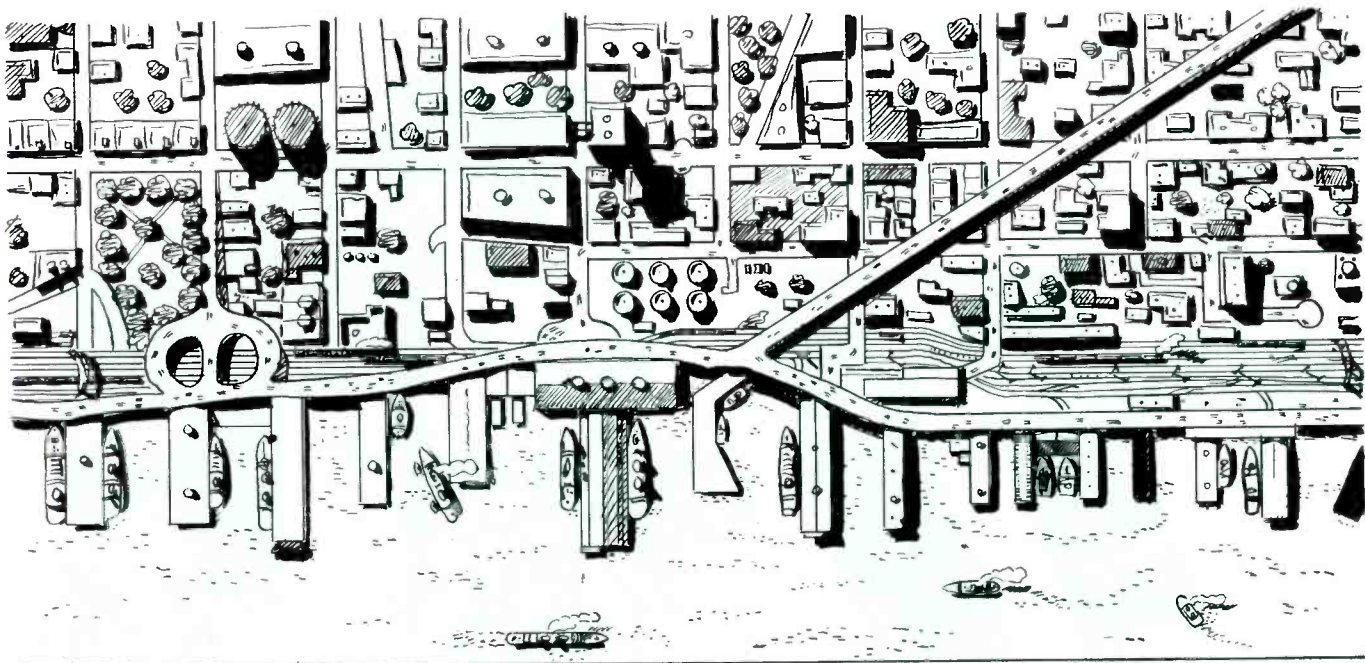

11 CAPACITOR

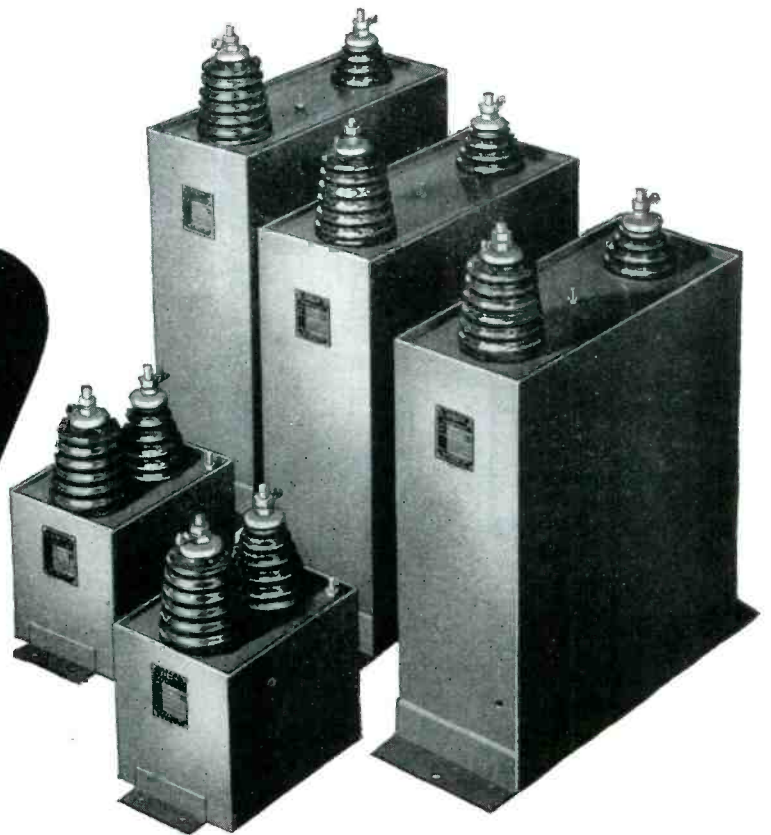

READNAUGHT'S

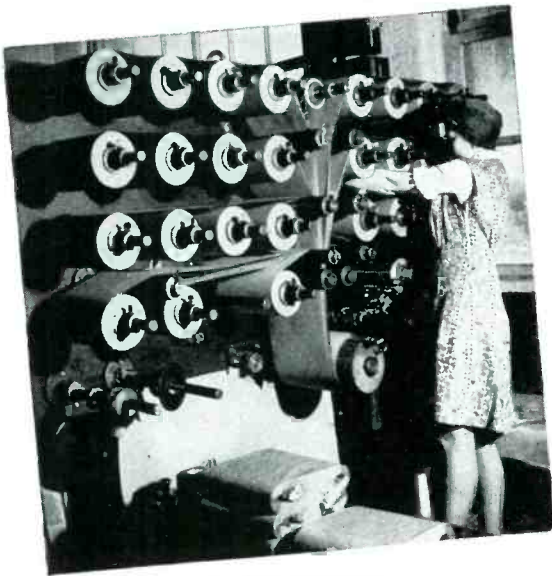

● Interested?
Write for detailed literature.

● Outstanding production equipment in the hands of Aerovox craftsmen, accounts for these veritable capacitor dreadnaughts. In exacting services such as radio transmitters, heavy-duty electronic equipment, and in the electric power field, these units have won citation after citation for exceptional ruggedness.

Such ruggedness stems from the Aerovox winding facilities second to none. Special winding machines insure that the multi-layered sections are uniformly and accurately wound under critically-controlled tension. Also, a system of impregnation tanks, pumps and control equipment guarantees the necessary drying after vacuum impregnation that is positively unexcelled by any impregnation process anywhere.

Hermetically-sealed welded steel containers; heavy-duty porcelain insulators; cork gaskets and pressure sealing; non-ferrous metal hardware; silver-soldered joints; sturdy mounting means—these are the externals of these capacitor dreadnaughts. Standard listings of Type 20 up to 50,000 v. D.C.W. Capacitances from 0.1 to 10 mfd.



Capacitors

INDIVIDUALLY TESTED

AEROVOX CORPORATION, NEW BEDFORD, MASS., U. S. A.

SALES OFFICES IN ALL PRINCIPAL CITIES

Export: 13 E. 40 St., New York 16, N. Y. • Cable: 'ARLAB' • In Canada: AEROVOX CANADA LTD., HAMILTON, ONT.



CLAIM STAKING

Hallicrafters and Very High Frequency

Based on the facts in the case, Hallicrafters can stake out a very strong claim to leadership in the very high frequency field. The facts include such things as the Model S-37, FM-AM receiver for very high frequency work. The Model S-37 operates from 130 to 210 Mc.—the highest frequency range of any general coverage commercial type receiver.

Hallicrafters further supports its claim to domination in the high frequency field with the Model S-36A, FM-AM-CW receiver. The 36A operates from 27.8 to 143 Mc., covers both old and new FM bands and is the only commercially built receiver covering this range.

Further developments in this direction can soon be revealed—adding further support to Hallicrafters claim to continued supremacy in the high frequency field.

HALLICRAFTERS NEW \$600,000 HOME NOW UNDER CONSTRUCTION.



hallicrafters RADIO



THE HALLICRAFTERS CO., MANUFACTURERS OF RADIO AND ELECTRONIC EQUIPMENT • CHICAGO 16, U. S. A.

COPYRIGHT 1945 THE HALLICRAFTERS CO.

Both are

FERRANTI

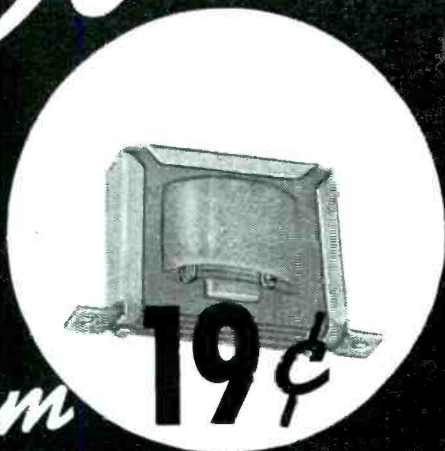

19¢

from
THE

**LOWEST PRICED
TRANSFORMER** *to*

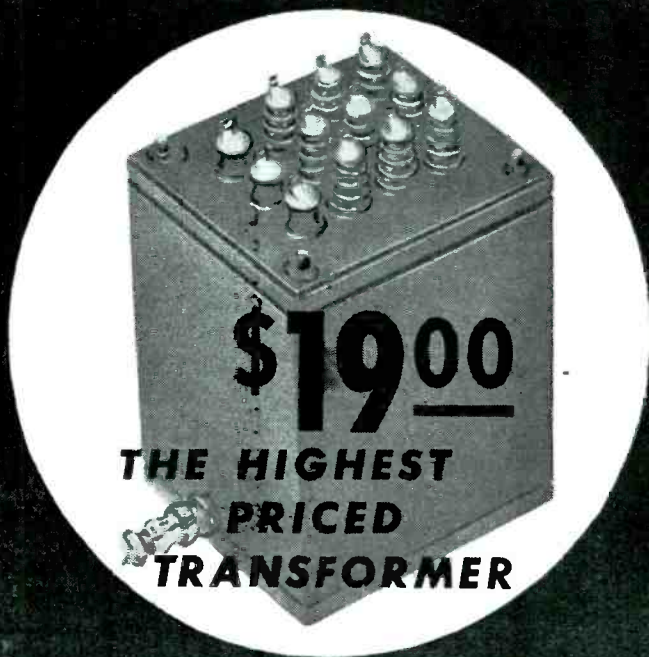

\$19⁰⁰

**THE HIGHEST
PRICED
TRANSFORMER**

Both backed by

**FERRANTI
HIGH QUALITY
PROMPT SERVICE
RAPID DELIVERY
and
COMPLETE ENGINEERING SERVICE**

Order any Quantity - no matter how small or large



FERRANTI ELECTRIC, INCORPORATED

NEW YORK 20

RCA

NEW YORK

BUILDING

TRANSFORMERS • CHOKES • FILTERS • WIRING AND ASSEMBLIES

Two rectifiers with citations for

RUGGEDNESS!



NOW AVAILABLE FOR PEACETIME APPLICATIONS

These rugged Chatham rectifiers offer proven dependability under severe operating conditions. Xenon gas fill results in heavy current capacity, low voltage drop, and high peak inverse voltage rating. Another feature is very wide ambient temperature range. Chatham engineering provides immunity to shock and vibration. Both types are especially applicable to mobile, airborne and remote installations where extreme

temperature ranges are encountered. Types 3B28 and 4B32 operate dependably, and without auxiliary heaters, within a temperature range of -75°C to $+90^{\circ}\text{C}$. All ratings are conservative and ample overload capacity prevents failure under accidental overload. Further details will be furnished promptly on request.

INQUIRIES
INVITED

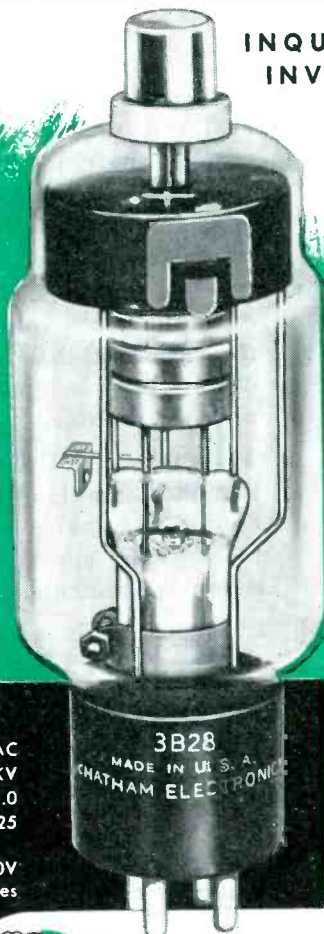

TYPE 3B28:
 Filament Volts2.5AC
 Peak Inv. Volts.....10.0KV
 Peak Anode Amps.....1.0
 Aver. Anode Amps....0.25
 Voltage Drop Approx.
 10V
 Height6.38 Inches



TYPE 4B32:
 Filament Volts5.0AC
 Peak Inv. Volts10KV
 Peak Anode Amps.....5.0
 Aver. Anode Amps....1.25
 Voltage Drop Approx.
 10V
 Height7.88 Inches



CHATHAM ELECTRONICS

475 WASHINGTON ST., NEWARK 2, NEW JERSEY

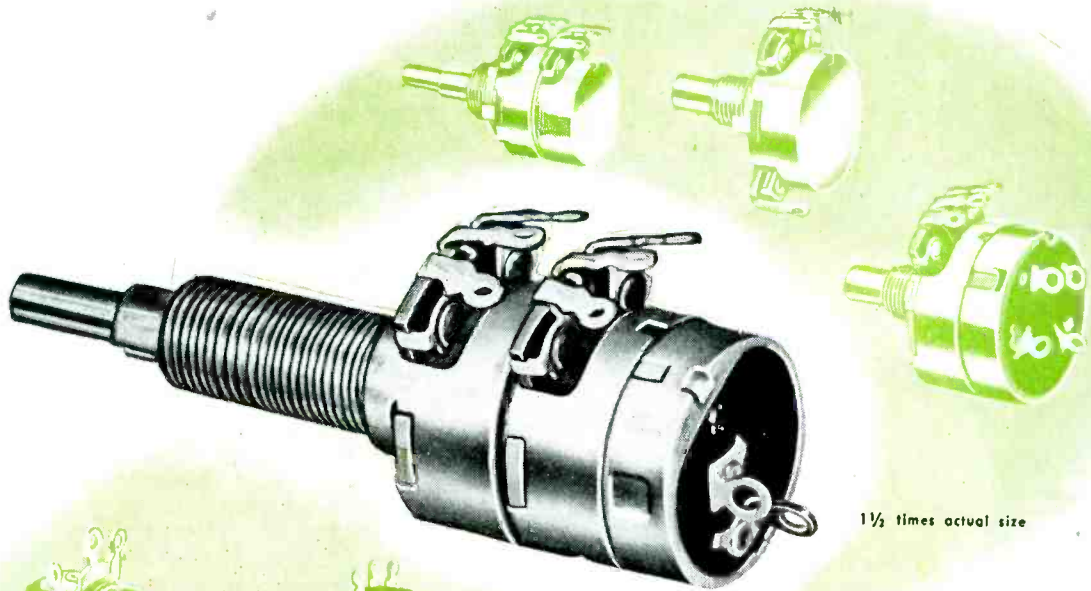

The Toughest Engineering Problems

Featured is CTS Type G-C-45-47 concentric shaft tandem tone control, volume control and off-on switch. This resistor was specially designed for use where panel space is limited and the going is rough—as in auto radios, for example. Both volume and tone controls are combined in this resistor and occupy only as much panel space as a single resistor.

This featured G-C-45-47 resistor is just one example of the ability of CTS engineers to solve new problems . . . to provide special adaptations for new requirements.

Electronic engineers all over the world depend on CTS for:

- A resistor engineered for the application.
- Uniform quality throughout the shipment.
- Each resistor carefully tested to assure top performance.
- Delivery when promised.

Call on CTS specialists for aid in solving your variable resistor problems.

REPRESENTATIVES

R. W. Farris Co.
406 West Thirty-fourth Street
Kansas City 2, Missouri
Phone: Logan 7495

Frank A. Emmet Co.
2837 West Pico Boulevard
Los Angeles 6, California
Phone: Rochester 9111

George A. Coleman
420 Market Street
San Francisco 11, Calif.

BRANCH OFFICES

S. J. Hutchinson, Jr.
401 North Broad Street
Philadelphia 8, Pennsylvania
Phone: Walnut 5389

IN ENGLAND

Chicago Telephone Supply Co.
St. John's Woods
103 Grove End Gardens
London, N. W. 8, England

CANADIAN ASSEMBLY PLANT

C. C. Meredith & Co.
Streetsville, Ontario



IN SOUTH AMERICA

Jose Luis Pontet
Cordoba 1472
Buenos Aires, Argentina
South America

Masculino 2624
Montevideo, Uruguay
South America

Avda. Conselheiro Rodrigues
Alves 1057
Villa Mariana
Sao Paulo, Brazil
South America

Walter Th. Kammann Willson
Apartado 1891
Norte 6 No. 17
Caracas, Venezuela
South America

CHICAGO TELEPHONE SUPPLY
Company

ELKHART ★ INDIANA

VARIABLE RESISTORS AND ASSOCIATED SWITCHES

Manufacturers of Quality Electro-Mechanical Components Since 1896

In **FM** too – The Same **TEMCO** Team Will continue to SET DELIVERY RECORDS

Bendix Radio

DIVISION OF BENDIX AVIATION CORPORATION
BALTIMORE 4, MARYLAND

August 3, 1945

Mr. M. B. Kahn
Transmitter Equipment Mfg. Co.
345 Hudson Street
New York-14, New York

Dear Mr. Kahn:

May we take this opportunity of expressing our appreciation and thanks for the efficient manner in which your firm has handled our orders for subcontracted items on the WPT equipment.

Your Company, by the all-out effort of yourself, your subordinates, and your personnel, have consistently met the requirements under the most trying conditions possible.

You are to be complemented on the flexibility and versatility of your operation. This has enabled you to put into effect with a minimum of effort the many changes necessary without jeopardizing our delivery requirements.

We have been advised that this is the first radar equipment ever ordered by the Army on which the schedules have been consistently met. For this also, we can thank TEMCO as you are building about seventy per cent of all the electrical components used on this contract.

In conclusion, may we convey our appreciation and thanks to the officers, supervisors and personnel of TEMCO for a job well done under the most trying conditions.

Cordially yours,

BENDIX RADIO, Division of
Bendix Aviation Corporation

R.A. Anderson
R.A. Anderson
Procurement Manager

Write for complete descriptive data, prices
and information for filing with
FCC for license application.

Improved
F M Broadcasting Equipment
NOW Being Produced by
TEMCO'S

Microwave Radar Technicians
NEW MODEL 250 BCF
NOW IN PRODUCTION

Normal Rated Output 250 Watts
Maximum Rated Output 375 Watts

Features...

- New miniature high frequency tubes permitting high efficiency and perfect shielding.
- Newly designed amplifier circuit completely eliminating tank radiation, feedback and radio frequency potentials from transmitting frame.
- Built-in center frequency deviation meter calibrated directly in cycles.
- Frequency range of 88-106 megacycles.
- Frequency stability ± 1500 cps or better of assigned center frequency.
- Audio frequency response $\pm 1\frac{1}{2}$ db 30-16000 cps (after deemphasis).
- Audio distortion 50-16000 cycles less than 2% RMS.
- Noise level FM db below ± 75 Kc swing.
- Noise level AM 70 db below 100% modulation.

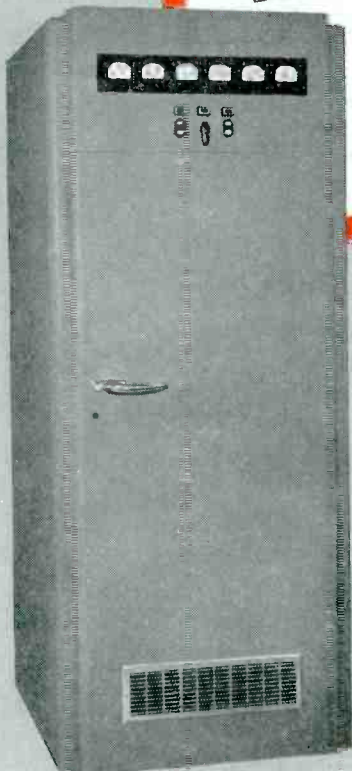

TEMCO

RADIO COMMUNICATION EQUIPMENT
TRANSMITTER EQUIPMENT MFG. CO., INC.

345 Hudson Street, New York 14, N. Y.

PRESTO-1946

A PREVIEW OF THE **NEWEST** PRESTO RECORDER

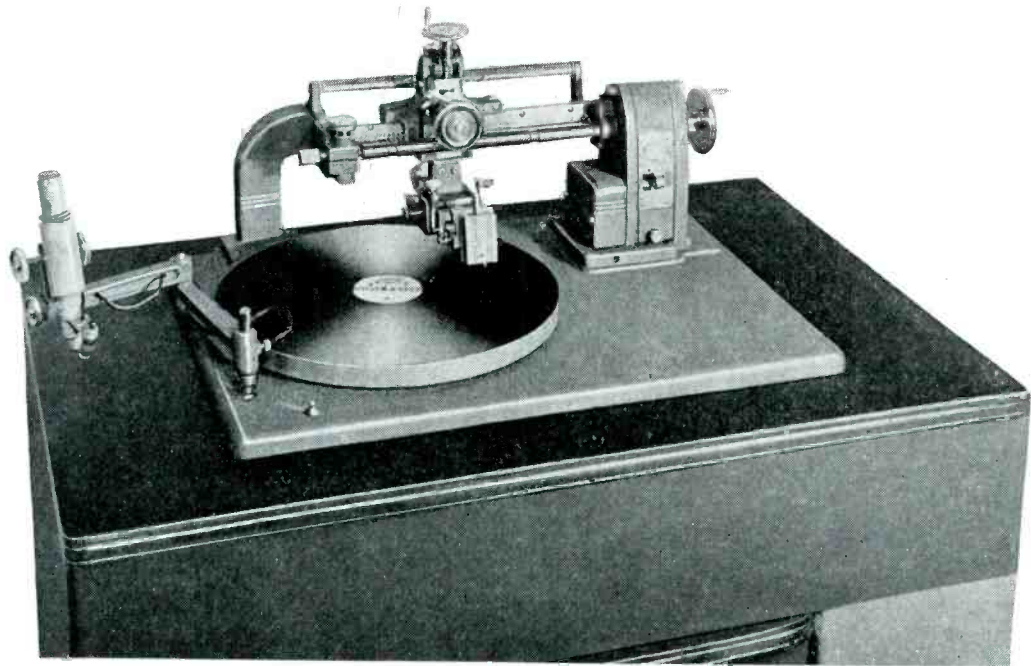

Presto's new 14A Recorder herewith makes its bow to all major radio stations, recording companies and motion picture studios. In presenting this model for the first time, Presto offers many new features that are fully described on Page One of Presto's postwar catalog. Send for Page One today.

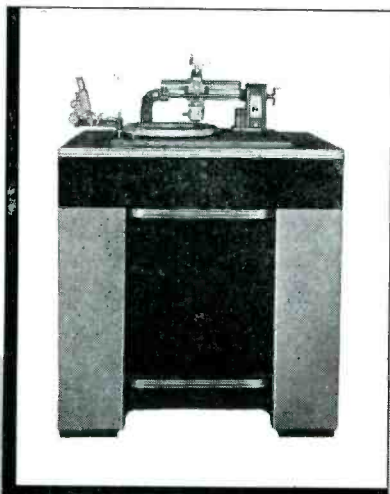

PRESTO

RECORDING CORPORATION

242 West 55th Street, New York 19, N. Y.

Walter P. Downs, Ltd., in Canada



WORLD'S LARGEST MANUFACTURER OF INSTANTANEOUS SOUND RECORDING EQUIPMENT AND DISCS

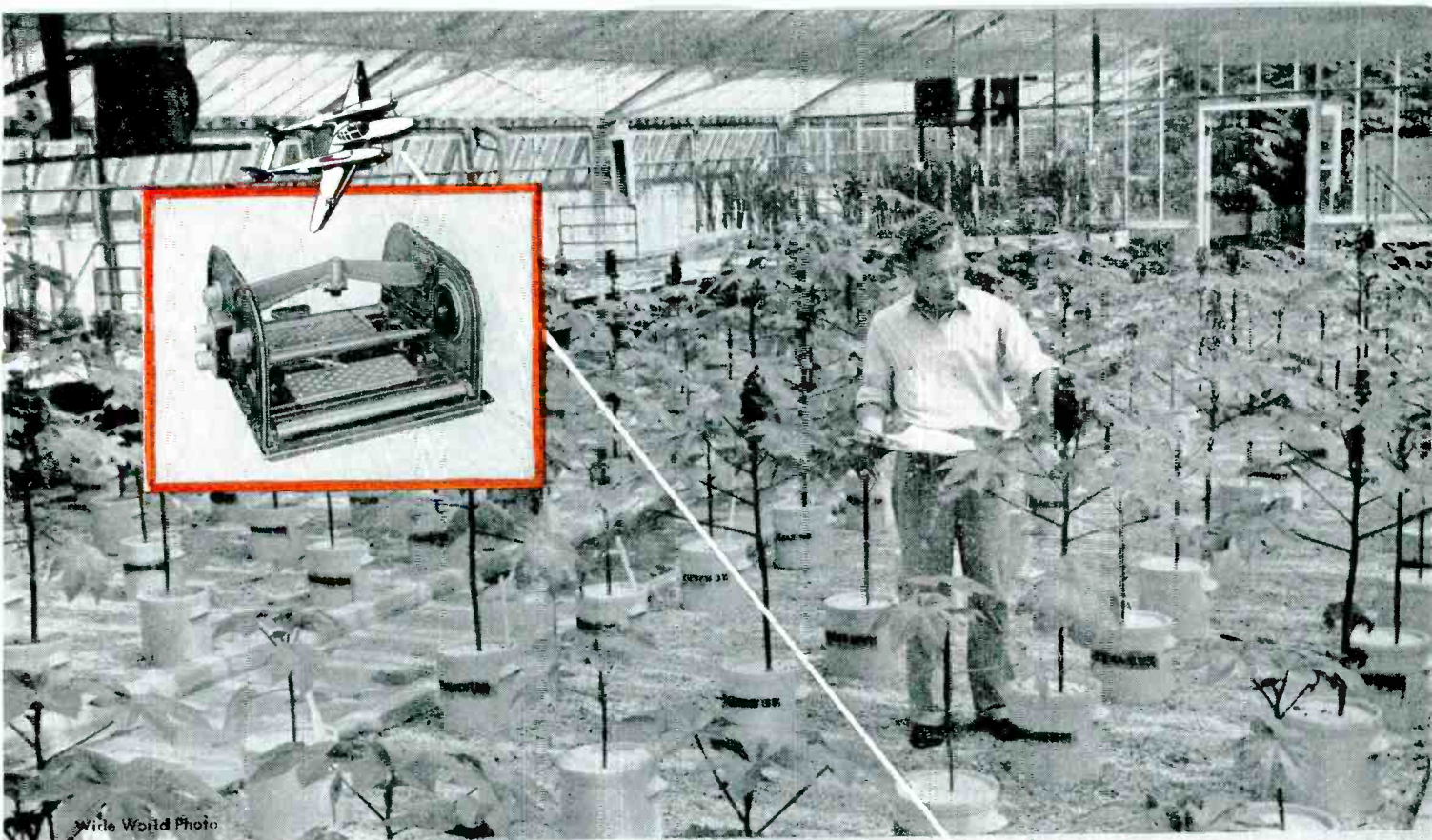

Wide World Photo

TURN ON THE

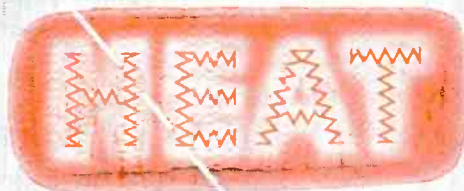

when and where you want it...

...with **NICHROME***

In addition to toasters, electric irons, radiant heaters, stoves, etc., the uses for electrical heating elements have multiplied into an almost endless list of new and novel applications during the war.

From keeping aerial cameras warm in the stratosphere to protecting delicate roots underground, Nichrome heating elements have been impressed into service to deliver dependable heat . . . wherever and whenever it is required.

In all of these applications the vital factor of dependability leaves no room for compromise with quality.

For this reason and because Nichrome insures long heater life and close control over wide temperature range, it has been specified for more new electrical heating applications than any other alloy resistance wire.

Although there are several excellent Nickel-Chromium combinations there is only one NICHROME and it is made only by Driver-Harris. For improved performance and longer life in your new products, specify Nichrome and other resistance alloys by Driver-Harris. Tell us what you need.

*Trade Mark Reg. U. S. Pat. Off.

NICHROME
is made only by



Driver-Harris
COMPANY
HARRISON, N. J.

BRANCHES: Chicago, Detroit, Cleveland, Los Angeles, San Francisco, Seattle

LET US DEMONSTRATE WHAT ELECTRONIC HEATING can do for YOU

PROOF BY TRIAL . . . that's our motto. Before you invest in electronic heating equipment you should be shown how any process requiring heat can be done *better, faster and more economically* for you with a Scientific Electric unit.

Our engineers will gladly—*without obligation*—make a study of the heating process under consideration. They will then make recommendations supported by practical demonstrations on the S.E. heater best suited for the job.

This procedure will enable you to figure accurately the economies that will result; also permit you to estimate the time required to pay for the equipment out of resultant savings.

You can submit your heating problems to us with the assurance that absolute secrecy will be observed, if so desired. Investigate the advantages of applying electronic heating in your manufacturing operations **NOW**. Consult with us at your earliest opportunity.

Write for free copy of
The ABC of Electronic Heating

**Manufacturers of
Vacuum Tube and Spark Gap Converters Since 1921**

Scientific Electric

DIVISION OF "S" CORRUGATED QUENCHED GAP COMPANY

119 MONROE ST.  GARFIELD, N. J.

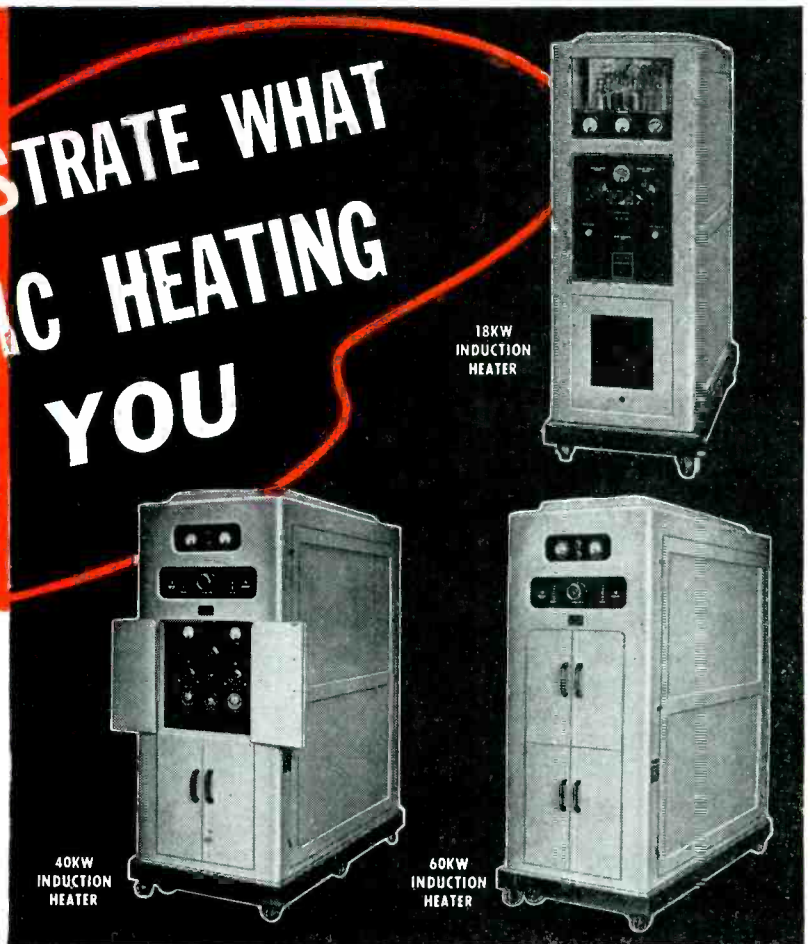

Dielectric Heating **\$1500.**
Units priced from
(3 KW complete)

Induction Heating **\$1285.**
Units priced from
(for 5 KW complete
with 1 work coil)

Scientific Electric Electronic Heaters are made in the following range of power; 3—5—7½—8—10—12½—15—18—25—40—60—80—100—250 KW. — and range of frequency up to 300 Megacycles depending on power required.

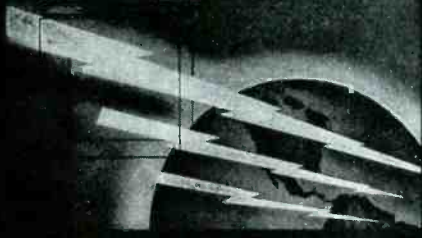

- PRECISION WIRE WOUND RESISTORS
- WHEATSTONE BRIDGES
- RADIO & ELECTRONIC TEST EQUIPMENT
- RADAR ASSEMBLIES

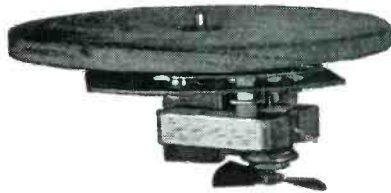

Eastern Electronics Corp.

PHONOGRAPH TURNTABLE UNIT

The need at this time for large quantities of phonograph turntable assemblies has prompted us to quickly design and tool up for the immediate production of this item. Engineers will find this compact turntable meeting all of their requirements for performance. We are prepared to make immediate deliveries and suggest that purchasing agents place their orders at once.

PERFORMANCE:—Correct and uniform speed is secured through the use of a motor of ample capacity, preloaded to operate on the flattest portion of the torque-speed characteristic.



ROTARY SELECTOR SWITCH

Designed for use where low contact resistance and mechanical sturdiness is required. Its construction insures long wear with low contact resistance of less than .001 ohm. May be arranged to have several sections to obtain multi-polar switching.

Well suited for precision test instruments; shunt ammeters, thermo-couple types, Wheatstone Bridges, and similar devices.

Korect-Ohm Precision Wire Wound Resistors

General Specifications

KORECT-OHM Resistors are wound on a sectional Ceramic bobbin, the direction of the winding being alternated on each section so that the resistor is non-inductive. Resistors can also be inductively wound when required.

To insure stability Korect-Ohm Resistors are aged and treated to relieve strains due to winding before the final adjustment is made.

Final resistance adjustment to an accuracy of better than .1%.

TEMPERATURE COEFFICIENT. Resistors are wound with selected alloy wire having a resistance change vs. temperature of less than .08% between —55 degree C and plus 55 degree C.

IMPREGNATION. A radically new material, INSO-FLEX, used for impregnating Korect-Ohm resistors has been developed by our engineering laboratory. This new material has several outstanding advantages, being extremely flexible it does not chip nor crack due to expansion or contraction under temperature variations. INSO-FLEX has high insulating qualities and is highly resistant to alkalis and weak acids, is resistant to moisture and mechanical shock. It forms an intimate bond between the ceramic bobbin, winding and lead wires. Being flexible, the lead wires may be bent and formed without disturbing the moisture-proof bond between the lead wires and INSO-FLEX covering.

Korect-Ohm resistors can also be supplied impregnated with our anti-fungi varnish or anti-fungi wax.



Type C
Maximum resistance 500,000 ohms.

Type A
Maximum resistance 1,000,000 ohms.

Type B
Maximum resistance 1,000,000 ohms.

Type XM
Instrument resistance shunt .1 ohms or lower. 25 watts.

We will make special resistors to any value or tolerance. Our Regular Line of Resistors are ready for delivery.

Eastern Electronics Corp.

41 CHESTNUT STREET, NEW HAVEN, CONN.

New York Sales Office

Turney & Beale
215-05 27th Ave.

Bayside, Long Island, N.Y.
Tel. BA 9-8958

Chicago Sales Office

Bauman & Bluzat

2753 West North Ave.
Tel. Humboldt 6809

Los Angeles Sales Office

Norman B. Neeley
7422 Melrose Ave.

Hollywood, Calif.
Tel. Whitney 1147

Boston Sales Office
11 Pemberton Square
Tel. Capitol 2425

HERE 3 CAPACITORS

DO TWICE THE WORK OF 25

A MANUFACTURER of induction heaters replaced 25 mica capacitors in his resonant (tank) circuit with three General Electric HFP parallel-plate, water-cooled capacitors. He saved nearly half the cost and space, and more than doubled the kva. Result: a more compact, more powerful, and more efficient heater.

Class HFP capacitors, with their two sets of heavy, sheet-aluminum plates, are specifically designed for use in resonant circuits of high-frequency oscillators, such as those employed in electronic heaters. Outstanding features of Class HFP capacitors are compact construction, and ability to operate at high voltages and to carry heavy continuous currents at frequencies from 50 kilocycles up into the megacycles. The special dielectric is a new, stable, synthetic liquid which combines the desirable characteristics of low loss, high dielectric constant, and high dielectric strength.

A coil of copper tubing, for water-cooling the capacitor, is installed inside the case in direct contact with the grounded pair of capacitor plates. Couplings are provided for connection to 3/8-in. copper tubing. The cooling feature permits a compact assembly and high current rating per unit volume.

The cases are of nonmagnetic metal, hermetically sealed, and flexible enough to take care of thermal expansion of the liquid dielectric. Capacitance tolerance is from plus 5 per cent to minus 5 per cent of the rated capacitance at 25 C; Q factor is above 2000 for full load operation at frequencies from 50 kilocycles to one megacycle. Internal inductance is low, which gives resonant frequencies from 3 to 9 megacycles, depending upon the capacitance rating. Write for Bulletin GEA-4365. Apparatus Dept., General Electric Company, Schenectady 5, N. Y.

Keep on buying BONDS—and keep all you buy

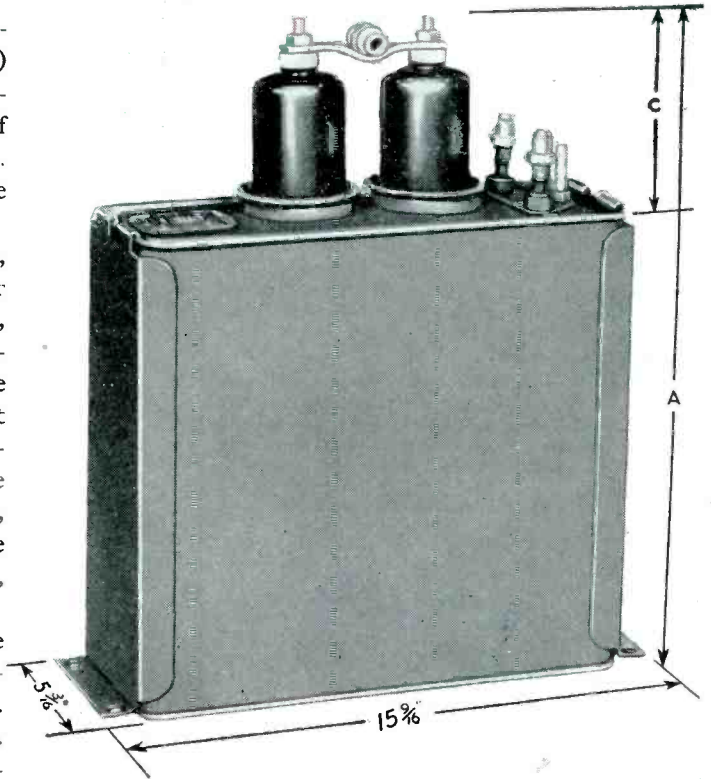

CLASS HFP HIGH-FREQUENCY, PARALLEL-PLATE, WATER-COOLED CAPACITORS

Maximum Permissible Rms Working Voltage	Microfarad Rating	Maximum Permissible Rms Working Current in Amp at 540 Kilocycles	Approximate Dimensions in Inches	
			A	C
2000	0.025	170	16 7/32	2 1/2
	0.030	204		
	0.034	230		
3000	0.0165	168	16 7/32	2 1/2
6000	0.0075	153	18 7/16	4 7/16
	0.01	204		
6600	0.009	202	18 7/16	4 7/16
	0.0029	88		
9000	0.005	153	18 7/16	4 7/16
	0.0056	171		

GENERAL  ELECTRIC

DIGEST

Timely Highlights on G-E Components

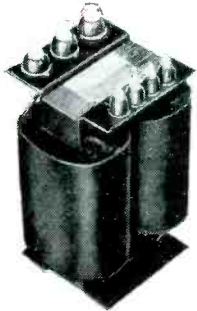

LIGHT-WEIGHT TRANSFORMERS

for tight spots

When size and weight are important and weather resistance isn't, G-E core-and-coil transformers solve a lot of electronic-design problems. Uniform coils, automatically wound over the finest-grade core laminations, are of the same high quality and give the same reliable performance as G-E cased transformers.

Standard core and coil units include 60 types and ratings of plate transformers, 106 filament transformers, 34 plate-and-filament transformers, and 61 reactors. Ratings up to 50 kva (physical size) are wound on standard laminated cores; larger units can be built from special parts. Write for Bulletin GEA-4280.

Small ONLY IN Size

Inside these G-E small panel instruments are packed accuracy and reliability usually associated with larger G-E instruments. They have space-saving internal-pivot construction. They respond quickly. Accurate readings are easily made. The instrument weighs a mere 3 ounces and is just 1½ inches wide and less than 1 inch deep. Either watertight or conventional construction is available for direct-current, audio-frequency and radio frequency applications. Write for Bulletin GEA-4380.

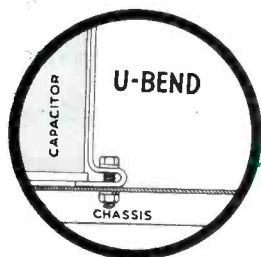

BRACKETS

that hold their own

A distinct advance in bracket design simplifies the mounting of rectangular-cased G-E capacitors. A U-bend replaces the conventional L-shape and provides a spring-washer effect for secure capacitor mounting. At the same time, it reduces strain on both capacitor and chassis, and compensates for tolerances in capacitor case heights.

For either base or inverted mounting, U-bend brackets are available for most G-E rectangular-case a-c and d-c capacitors. Write for Bulletin GEA-4357.

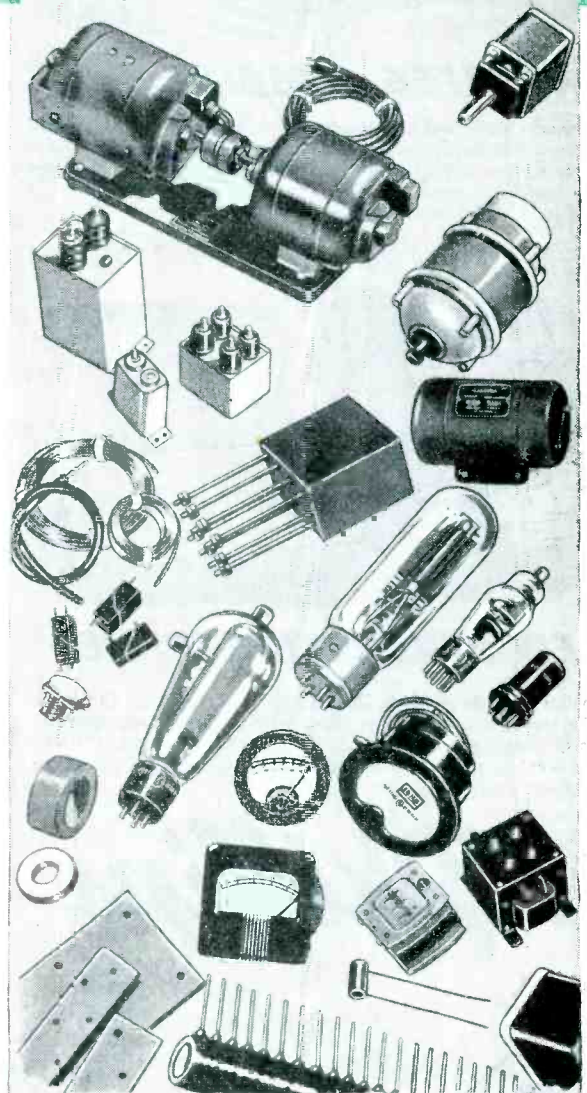

Capacitors • Sensitive control and time-delay relays • Limit switches • Motors, dynamotors, amplidyne • Motor-generator sets • Alnico magnets • Small panel instruments • Formex[®] magnet wire • Radio transformers • Switchettes • Selsyns • Chokes • also tubes, crystals, plastics products, insulation materials, and many others

General Electric Company
Apparatus Dept., Sec. 642-10
Schenectady 5, N. Y.

Please send me the bulletins checked:

..... GEA-4365
..... GEA-4380

..... GEA-4280
..... GEA-4357

NAME

COMPANY

ADDRESS

CITY

STATE



TROUBLES SUBSIDE

It was a slow and troublesome job to drive small slotted screws in fastening a pressed fabric panel on this electrical relay for the P-80 Jet Plane. Frequent driver skids gouged the special fungus-resistant varnish, forced disassembly and junking of marred panels.



OUTPUT HITS STRIDE

Assembly of this part was speeded up 400% when a change was made to Phillips Recessed Head Screws. Fumbling was ended, and a spiral driver could be used, permitting faster driving. Driver skids were eliminated, along with waste of parts and time for disassembly and reassembly.

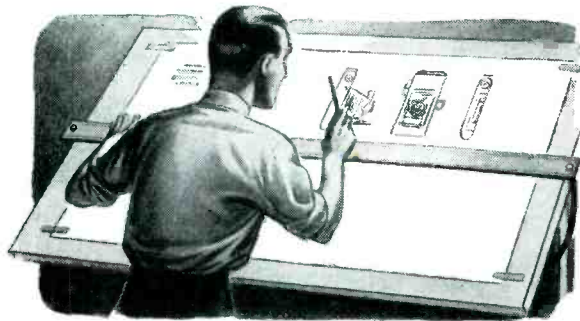

NEW STRENGTH SUPPLIED

Design engineers favor Phillips Screws, because they not only speed output and reduce costs . . . they also permit design improvements that add strength, often with the use of fewer screws. This advantage is especially evident in compact, complicated assemblies.



SHOW IT WITH PRIDE

Wherever screw heads are exposed, the Phillips Recess adds a sales advantage. No unsightly burrs to snag clothing or nick fingers - and sidetrack sales! Its ornamental design blends with modern contours - and it needs only a quarter turn to line up - looks well in any position.

It's Phillips *the engineered recess!*



In the Phillips Recess, mechanical principles are so correctly applied that every angle, plane, and dimension contributes fully to screw-driving efficiency.

... It's the exact pitch of the angles that eliminates driver skids.

... It's the engineered design of the 16 planes that makes it easy to apply full turning power - without reaming.

... It's the "just-right" depth of recess that enables Phillips Screw Heads to take heaviest driving pressures.

With such precise engineering, is it any wonder that Phillips Screws speed driving as much as 50% - cut costs correspondingly?

To give workers a chance to do their best, give them faster, easier-driving Phillips Recessed Head Screws. Plan Phillips Screws into your product now.

PHILLIPS *Recessed Head* SCREWS

WOOD SCREWS • MACHINE SCREWS • SELF-TAPPING SCREWS • STOVE BOLTS

Made in all sizes, types and head styles

**25
SOURCES**

American Screw Co., Providence, R. I.
Atlantic Screw Works, Hartford, Conn.
The Bristol Co., Waterbury, Conn.
Central Screw Co., Chicago, Ill.
Chandler Products Corp., Cleveland, Ohio
Continental Screw Co., New Bedford, Mass.
The Corbin Screw Corp., New Britain, Conn.
General Screw Mfg. Co., Chicago, Ill.

The H. M. Harger Co., Chicago, Ill.
International Screw Co., Detroit, Mich.
The Lamson & Sessions Co., Cleveland, Ohio
Manufacturers Screw Products, Chicago, Ill.
Milford Rivet and Machine Co., Milford, Conn.
The National Screw & Mfg. Co., Cleveland, Ohio
New England Screw Co., Keene, N. H.
Parker-Kalon Corp., New York, N. Y.
Pawtucket Screw Co., Pawtucket, R. I.

Shell Manufacturing Co., Chicago, Ill.
Reading Screw Co., Norristown, Pa.
Russell Burdett & Ward Bolt & Nut Co., Port Chester, N. Y.
Sovill Manufacturing Co., Waterville, Conn.
Shakerproof Inc., Chicago, Ill.
The Southington Hardware Mfg. Co., Southington, Conn.
The Steel Company of Canada Ltd., Hamilton, Canada
Wolverine Bolt Co., Detroit, Mich.



DECIDE ON **DIEFLEX**
 VARNISHED TUBING PRODUCTS
 ...**THEY'RE THE BEST**

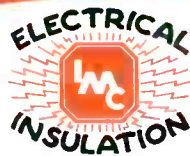

Dieflex Varnished Tubing Products are made of closely braided sleeveings completely impregnated and treated with special insulating varnishes. A smooth inside bore to prevent snagging, uniformity of size, complete roundness, maximum flexibility, and excellent ageing qualities are found in all Dieflex products. They do not fray or pinch when cut.

Cotton or Fiberglas Base Tubings and Sleeveings—Dieflex Varnished Tubing Products are made both with cotton base or glass base braided sleeveings in all standard grades and sizes.

Dieflex Varnished Tubing Products—both cotton and Fiberglas base—are made to meet and surpass the V.T.A. and A.S.T.M. standards. Grade A-1 Magneto quality, Grade B-1 Radio quality varnished tubings, and Grades C-1 Extra Heavily Coated, C-2 Heavily Coated, and C-3 Lightly Coated Saturated Sleeveings are “tops in quality.”

Silicone Treated Fiberglas Tubings and Sleeveings are also now available. These are made by impregnating and treating Fiberglas Sleeveings with the latest Dow Corning high temperature resins.

INSULATION

MANUFACTURERS CORPORATION

★CHICAGO 6
 565 West Washington Blvd.

★CLEVELAND 14
 1005 Leader Building

Representatives in:
 MILWAUKEE 2: 312 East Wisconsin Avenue
 DETROIT 2: 11341 Woodward Avenue
 MINNEAPOLIS 3: 1208 Harmon Place
 PEORIA 5: 101 Heinz Court

OTHER IMC PRODUCTS—Vartex Varnished Cloth and Tapes—Varslot Combination Slot Insulation—Varnished Silk and Paper—Fiberglas Electrical Insulation—Manning Insulating Papers and Pressboards—Dow Corning Silicones—Pedigree Varnishes—Hard Vulcanized Fibre and Fishpaper—Laminated Bakelite—Adhesive Tapes—Asbestos Woven Tapes and Sleeveings—Cotton Tapes, Webbing, Sleeveings, Wood Wedges, and other insulating materials.



Must we go back?

The evolution of electronics will always remain a bright page in the history books of science. And the record has been significantly brilliant during the past four years when improvements and developments were advanced at a faster rate than normal. With the ending of the war, there may be a few who do not feel the urgency to progress at a similar pace . . . who will be willing to relax the rigid wartime standards. Or there may be those who do not too accurately gauge the temper of the consumer, now in a mood to anticipate only the best from an industry which has accomplished such miracles in the past few years.

Along with many other far-sighted producers, we here at Marion fully intend to maintain our wartime quality pattern, and to cooperate in every known way to provide even better products for a peaceful world. We endorse the postwar standardization program of the Army and Navy Electronics Standards Agency, and will continue to manufacture all Marion electrical indicating instruments in conformity with JAN specifications. Our customers have a right to expect nothing else.

It is important to note that continued adherence to the Electronics Standards Agency program need not result in increased costs, either to the manufacturer or the consumer . . . while it will definitely result in improved product performance wherever such standardized components are used.

We, the manufacturers, engineers, consumers of electronics, are part of a vital, daring, visionary industry. It is with this realization that we are faced with the responsibility of deciding, at this time, whether we can relax, or whether we shouldn't give as much to a world at peace as we gave to a world at war.

Your comments will be welcomed.



MARION ELECTRICAL INSTRUMENT CO.
MANCHESTER, NEW HAMPSHIRE

EXPORT DIVISION 458 BROADWAY · NEW YORK 13, N. Y., U. S. A.
CABLE ADDRESS: MORMANEX

COMPACT CONTROLS

with Allied's "E" and "F" Relays

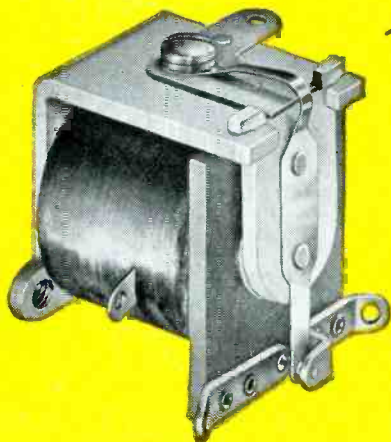

The E relay illustrated is a single pole, double throw arrangement. The standard silver contacts are capable of carrying one ampere at 24 volts DC or 115 volts AC non-inductive. Insulation is bakelite. Alloy contacts are available. Other contact arrangements may be furnished. The E is 15/16" high, 1 1/16" wide and 1 1/15" long. Weight 1 1/8 ounces.

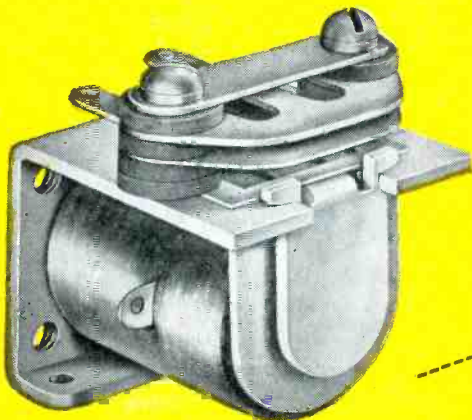

The F relay shown is a single pole, single throw normally open combination. The standard contacts carry three amperes at 24 volts DC or 115 volts AC non-inductive. Bakelite insulation is used. May be supplied on other contact combinations. Silver is standard contact material, alloy contacts can be substituted. The F is 1 11/32" high, 1 3/16" wide and 1 3/32" long. Weight is 1 7/8 ounces.



DESIGNED for electronic controls in which space limitation is a critical factor, the E relay is small enough to fit into an area of approximately one cubic inch. Light too, it weighs about one ounce. The F relay, although available in two pole, double throw, is only slightly larger and weighs less than two ounces.

Used in your electronic assembly these relays will save you space and weight. Moreover you will be assured of positive and quiet operation, for into these relays go the same careful design and manufacturing precision found in Allied's larger relays.

Whatever your relay applications, check with Allied. In addition to sensitive, telephone, power, differential and other types of relays Allied manufactures solenoids and electro-magnetic devices. A number of strategically located plants are available to supply your immediate requirements. Allied's quality standard is in keeping with your post war products . . . write today for more information.



ALLIED CONTROL COMPANY, INC.

GENERAL OFFICES: 2 East End Ave. (of 79th St.) New York 21, N. Y. Factories: New York City (2 East End Ave.) — Plantsville, Conn. Chicago—4321 N. Knox Avenue, Chicago 41, Illinois. In California: Allied Control Co. of California, Inc. 1633 South Hope St., Los Angeles 15, Calif.



Centralab METALLIZED STEATITE

COIL forms, spacer rods, strain insulators and rotor shafts of steatite can now be bonded in an inseparable union with brass, stainless steel, silver, copper and other metals. These shafts of steatite and metal are indicated wherever high frequency insulating material is specified. Both electrically and mechanically they fulfill the most exacting requirements. . . . Centralab is now equipped to supply metallized Steatite in practically any form.

**Centralab**

Division of GLOBE-UNION INC., Milwaukee

PRODUCERS OF: Variable Resistors • Selector Switches
• Ceramic Capacitors, Fixed and Variable • Steatite
Insulators and Button-type Silver Mica Capacitors.



SYNTHETICS FOR ELECTRONICS

CONNECTORS

STEATITE SOCKETS

SYNTHETICS FOR ELECTRONICS

COAXIAL CABLES

A-N FITTINGS

**The Line That Reaches
'Round the World**



A-N CONNECTORS

CONNECTORS

PREFOCUSED LAMP RECEPTACLES

MICROPHONE CONNECTORS

With a proven background of honorable service on far-flung battlefronts around the world, Amphenol components — greatly improved by wartime experience and augmented in number, style and type — are now available to normal markets. Simplifying both buying and selling, this wider selection of high quality, tested items can be procured from one manufacturer. To know these popular Amphenol products better — write today for the new Condensed Catalog No. 72.

AMERICAN PHENOLIC CORPORATION
CHICAGO 50, ILLINOIS

In Canada • Amphenol Limited • Toronto

U.H.F. Cables and Connectors • Conduit • Cable Assemblies • Connectors (A-N, U.H.F., British) • Radio Parts • Plastics for Industry

Problem Solvers

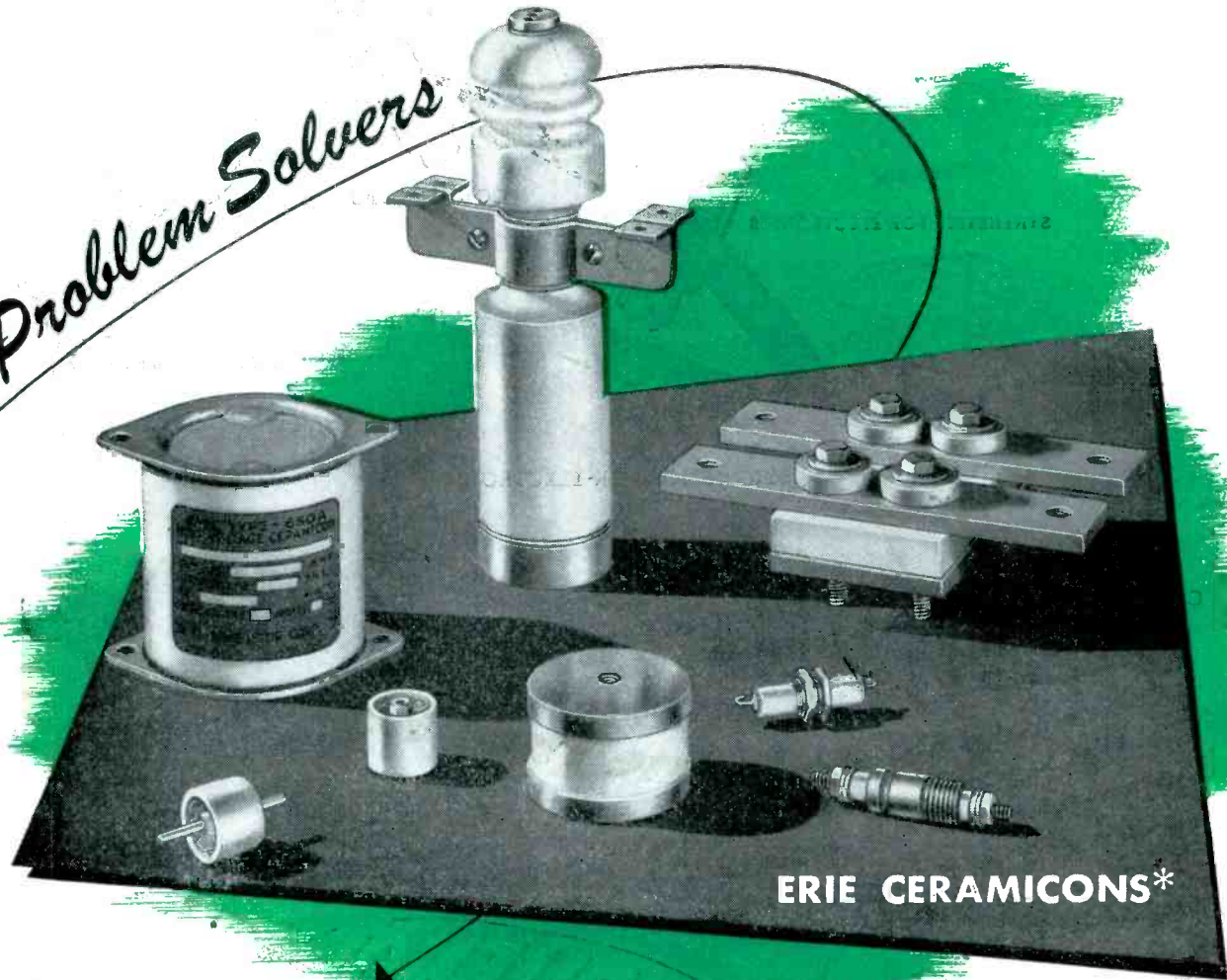

ERIE CERAMICONS*

For Electronic Heating and Television Capacitor Applications

WITH the growing importance of electronic heating and television, design engineers can find the solution to many of their capacitor problems in Erie Ceramicons.

These silvered-ceramic condensers offer advantages because of their low inductance at high frequencies and extremely simple construction that eliminates circulating currents tending to reduce power ratings. Design is further simplified by the fact that where required, corona shields are incorporated directly into the ceramic dielectrics.

Erie Resistor has developed a number of High Voltage and High KVA Ceramicons of special design and several standard styles are now in production. Included in the above group is a specially designed 30,000 volt

feed-thru Ceramicon; a dual filament by-pass unit having conductors to carry 325 amps. The standard Erie Resistor High Voltage ceramic condensers shown include two styles of double cup Ceramicons; a new double cup unit for television power supply filtering, rated at 500 MMF and 10,000 volts D. C.; two High Voltage feed-thru Ceramicons; and a High KVA, High Voltage, multiple plate condenser comparable in size to mica type CM75 but particularly adapted to use at very high frequencies.

Write for data sheets on standard Erie Ceramicons for television and electronic heating applications. You are invited to make use of our extensive knowledge and background for the development of special Ceramicons for these applications.



* CERAMICON IS THE REGISTERED TRADE NAME OF SILVERED CERAMIC CONDENSERS MADE BY ERIE RESISTOR CORPORATION.

★ BUY VICTORY BONDS ★

Electronics Division
ERIE RESISTOR CORP., ERIE, PA.

LONDON, ENGLAND

TORONTO, CANADA.



LABORATORY INSTRUMENTS FOR SPEED AND ACCURACY



TAILOR-MADE WAVES FOR RAPID TESTING

The *-hp-* Model 210A Square Wave Generator is designed to amplify and clip the tops of a sine wave, and thus convert it into a wave which has vertical sides and a flat top. When the square wave voltage is applied to the amplifier or network under test, the shape of the output wave immediately shows up any distortion.

In production testing, one or two observations with an *-hp-* Square Wave Generator will accurately check the frequency response. In development work, the *-hp-* Model 210A shows up phase shift and transient effects, both of which are difficult to study by other methods.

In practice, a wave which appears to be perfectly square will contain 30 or more harmonics; and when the amplitude or phase re-

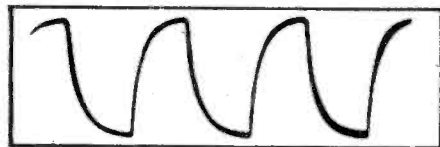

Fig. 1—Shows the square wave distortion caused by poor high frequency response

lation of the harmonics is disturbed, the square wave will be distorted. (See Fig. 1.) Thus the application of a square wave to a circuit shows up any irregularities in amplitude or phase

transmission of that circuit, not only at the square wave frequency, but also at frequencies far removed from the test point. These characteristics are particularly important in television video amplifier work.

The output of the generator is square within 1 percent over the frequency range from 20 cps to 10,000 cps; a relatively square wave can be obtained even at 100 kc. The frequency response of the attenuator is sufficiently wide so that the output wave shape is not affected even at the highest frequencies. Once proper criteria have been established, the *-hp-* Model 210A Square Wave Generator is the modern,

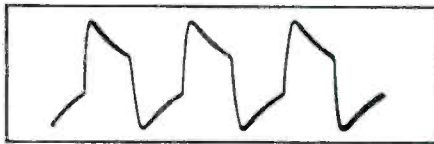

Fig. 2—Low frequency phase distortion serious in television video circuits

rapid means of production testing, with the speed and accuracy which are characteristic of all *-hp-* instruments.

Write for complete details on the Model 210A. Ask for *-hp-* Catalog No. 17B, which includes much valuable information on development and measurements.

HEWLETT-PACKARD COMPANY

BOX 1134 • STATION A • PALO ALTO, CALIFORNIA

Audio Frequency Oscillators

Signal Generators

Vacuum Tube Voltmeters

Noise and Distortion Analyzers

Wave Analyzers

Frequency Meters

Square Wave Generators

Frequency Standards

Attenuators

Electronic Tachometers

OTHER *-hp-* INSTRUMENTS



RESISTANCE-TUNED AUDIO OSCILLATORS

Require no zero setting . . . Several models available to cover frequency ranges from 2 cps to 200 kc.



NOISE AND DISTORTION ANALYZER MODEL 325B

Combines a vacuum-tube voltmeter with a set of fundamental elimination filters for general purpose measurements of total harmonic distortion, noise and voltage level.



VACUUM TUBE VOLTMETER MODEL 400A

Makes accurate voltage measurements from 10 cycles to 1 megacycle, covers nine ranges, (.03 volts to 300 volts) with full scale sensitivity.

An Outstanding New Line of A.C. and D.C. RELAYS

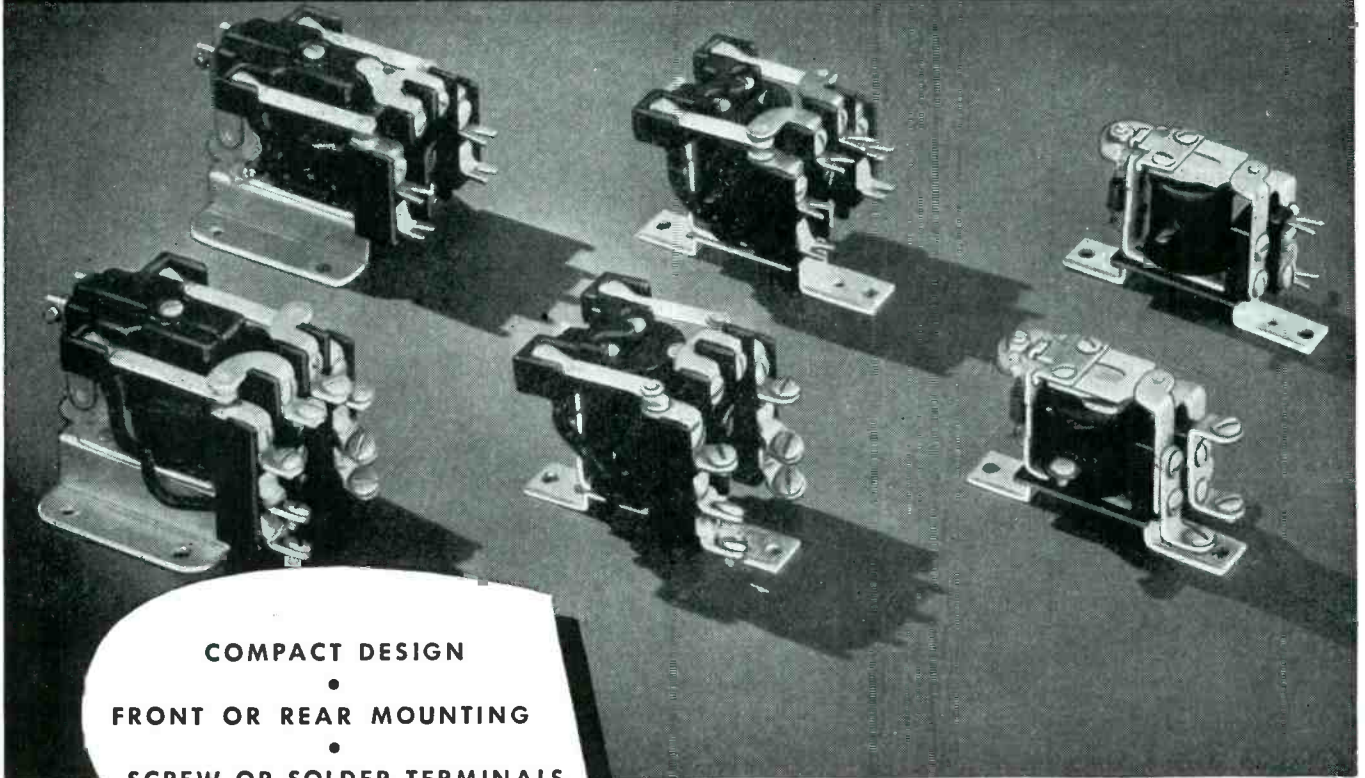

COMPACT DESIGN
•
FRONT OR REAR MOUNTING
•
SCREW OR SOLDER TERMINALS

● R-B-M announces a new and improved design of magnetic relays rated 10 amperes at 24 volts D. C. and 110 volts A. C. and 5 amperes at 220 A. C. Relays rated at one horse power single phase 110 and 220 volts A. C. Silver to silver contacts. Self-aligning armature. All wiring terminals accessible from front. Contact arrangement—single and double pole; normally open, normally closed and double throw. Steel

mounting with A. C. and D. C. relay mounting dimensions interchangeable. Available in open type or with sheet steel general purpose enclosure. Bulletin 510 on D. C. relays and Bulletin 560 on A. C. relays available upon request. Write Department A-12 . . .

R-B-M MANUFACTURING COMPANY
Division of
ESSEX WIRE CORPORATION
LOGANSPORT, INDIANA

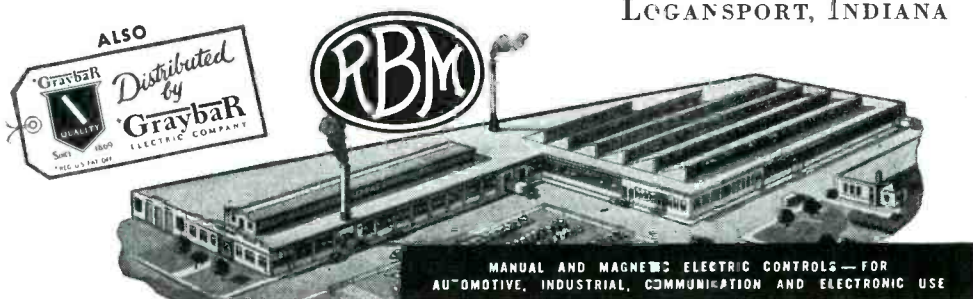

MANUAL AND MAGNETIC ELECTRIC CONTROLS — FOR
AUTOMOTIVE, INDUSTRIAL, COMMUNICATION AND ELECTRONIC USE

Take Action



SPECIFY G-S SMALL GEARS

Gears are no better than the skill of the organization which produces them. No branch of the component part field is so dependent upon craftsmen. Wise buyers of gears know this fact and buy not a gear but the product of an organization which they know to be qualified to produce superior work. That's the reason why G-S is the world's largest exclusive manufacturer of small gears. This experience is not merely a statistic but is tangibly expressed in the ability of our organization to put the utmost quality in every job. G-S Small Gears offer economy, longer life, trouble-free operation, smooth performance, un-failing dependability. Let us discuss *your* Small Gear problems with you, *now!*

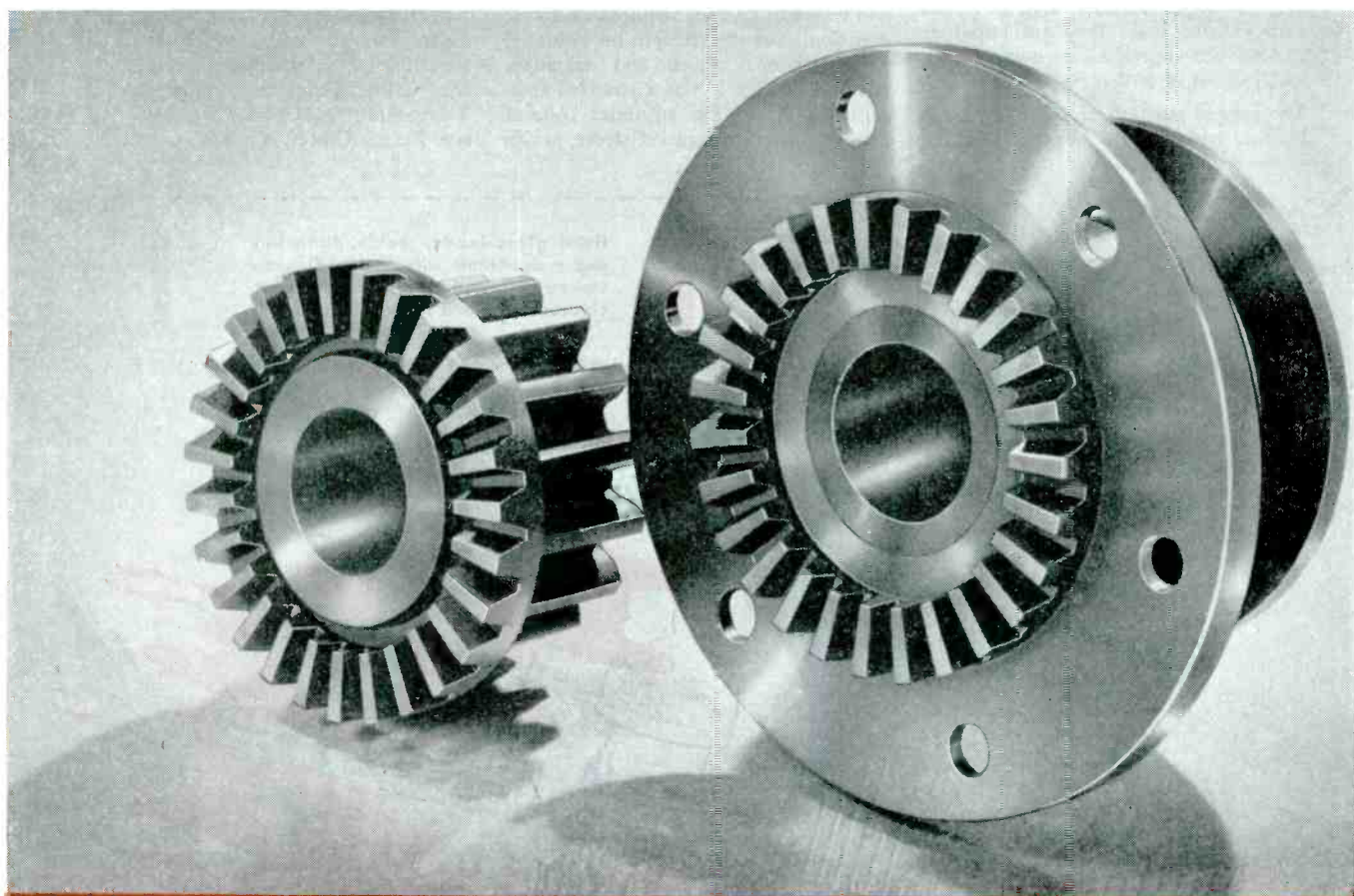

GEAR Specialties

Spurs • Spirals • Helicals • Bevels • Internals • Worm Gearing • Racks • Thread Grinding
2635 WEST MEDILL AVENUE • CHICAGO 47, ILLINOIS

WORLD'S LARGEST EXCLUSIVE MANUFACTURERS OF FRACTIONAL HORSEPOWER GEARS

Callite tube parts

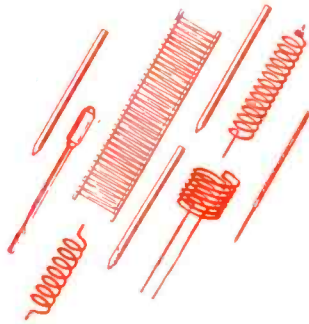

make General Electronics' power tubes extra rugged...

The DR575A is a heavy-duty, half-wave, mercury vapor rectifier manufactured by General Electronics, Inc. for use in induction heating apparatus. Here these tubes have proved their capacity to stand up under gruelling conditions for thousands of hours. Though rated at 15,000 volts inverse peak, they are tested at 25,000 volts—providing an overload factor in excess of 50%.

The rugged strength of the DR575A is built-in with Callite thoriated tungsten

filament, "Kulgrid" leads and molybdenum rods. These Callite components permit higher operating temperatures with increased emission efficiencies.

Callite thoriated tungsten filaments contain the right proportions of tungsten and thoria to give the required electronic emission, plus the strength to withstand severe thermal shock and vibration. Callite's "Kulgrid"* is a stranded composite wire, having an inner core of copper bonded to a nickel sleeve, which

does not oxidize nor become brittle at high temperatures. Callite's high purity molybdenum rod is known for its excellent working properties and complete freedom from oxidation.

If you are striving for new highs in tube performance, investigate our specialized abilities and complete facilities for all kinds of metallurgical components. Callite Tungsten Corporation, 544 Thirty-ninth St., Union City, New Jersey. Branch Offices: Chicago, Cleveland.

Callite
Tube components



Hard glass leads, welds, tungsten and molybdenum wire, rod and sheet, formed parts and other components for electron tubes and incandescent lamps.

OVER 25 YEARS PIONEERS IN TUNGSTEN METALLURGY.

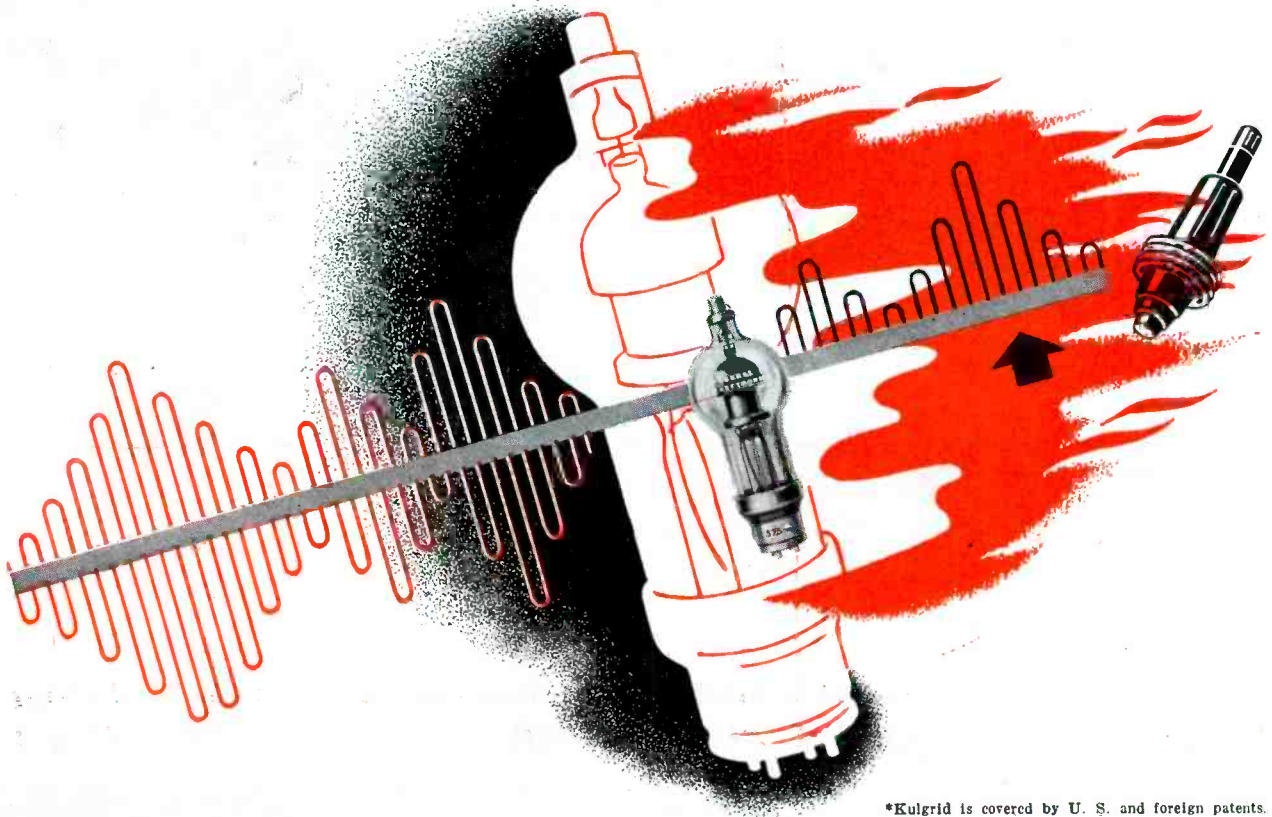

*Kulgrid is covered by U. S. and foreign patents.

SELECTOR MECHANISMS

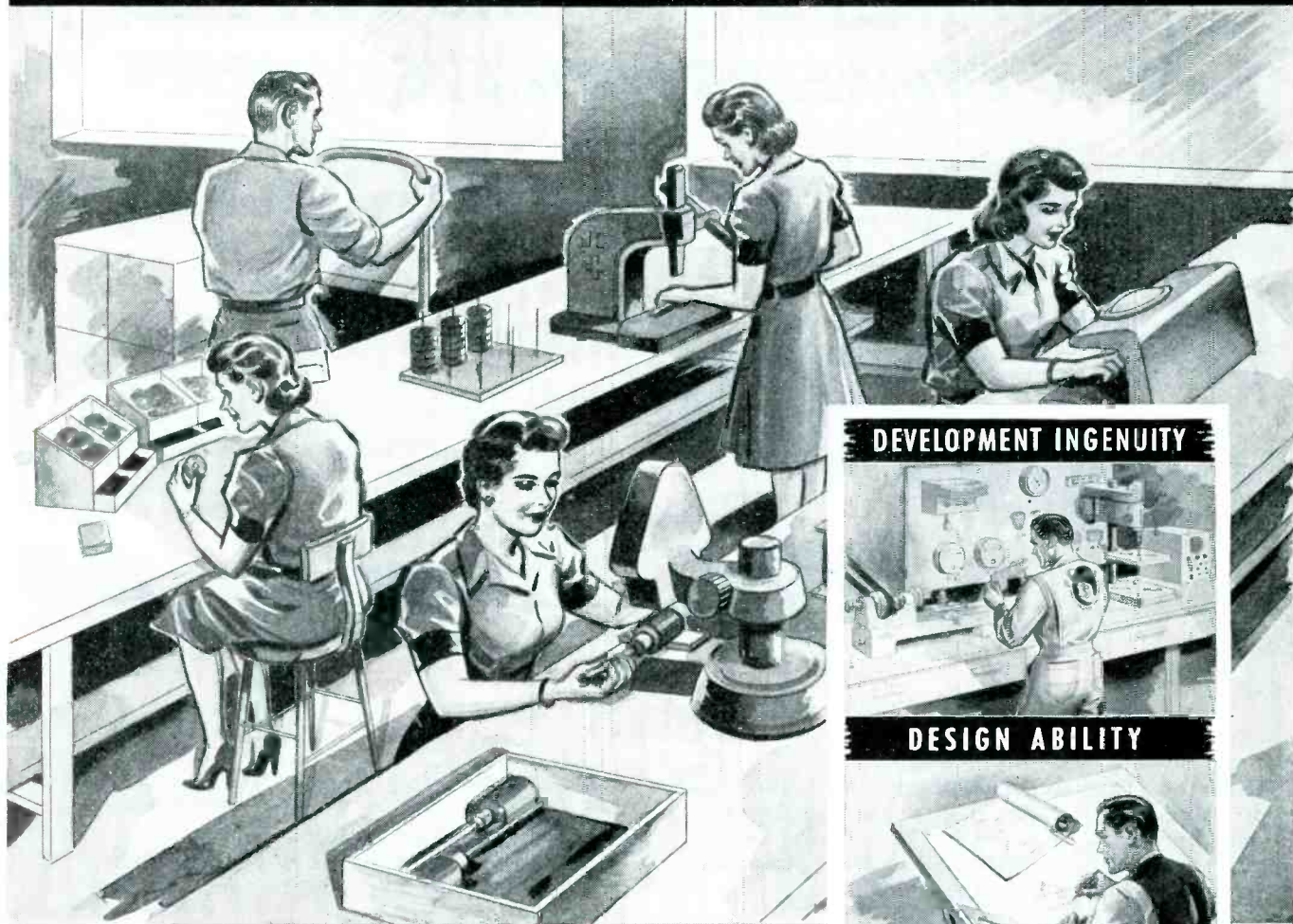

DEVELOPMENT INGENUITY



DESIGN ABILITY

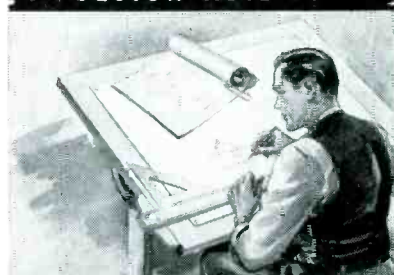

DESIRE TO SERVE

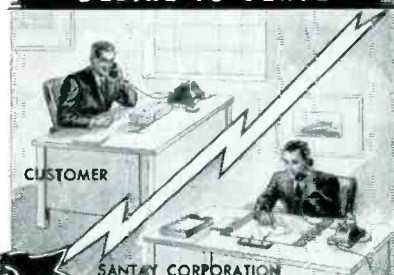

MANUFACTURING FACILITIES

Santay has the manufacturing facilities to produce *Selector Mechanisms* for you.

In addition to the necessary machines needed to perform assembly operations, Santay has (1) the engineers to design and the tool makers to build the special jigs and fixtures, so often needed, and (2) the production engineers and methods to assure accurate work and prompt delivery.

When you are considering a Selector Mechanism, of your own design or a combination of your design and ours, consult Santay.

INJECTION MOLDING AND METAL STAMPING • ELECTRO-MECHANICAL ASSEMBLIES



SANTAY CORPORATION, 353 NORTH CRAWFORD AVE., CHICAGO 24, ILLINOIS

REPRESENTATIVES: POTTER & DUGAN, INC., 29 WILKESON STREET, BUFFALO 2, NEW YORK • PAUL SEILER, 3779 CORTLAND AVENUE, DETROIT 4, MICHIGAN • OUFISSEY BROS., 110 E. NINTH STREET, INDIANAPOLIS 2, INDIANA

**BUT THEY SAY CORNING SUPPLIES
4 ENGINEERS WITH EVERY ORDER!**

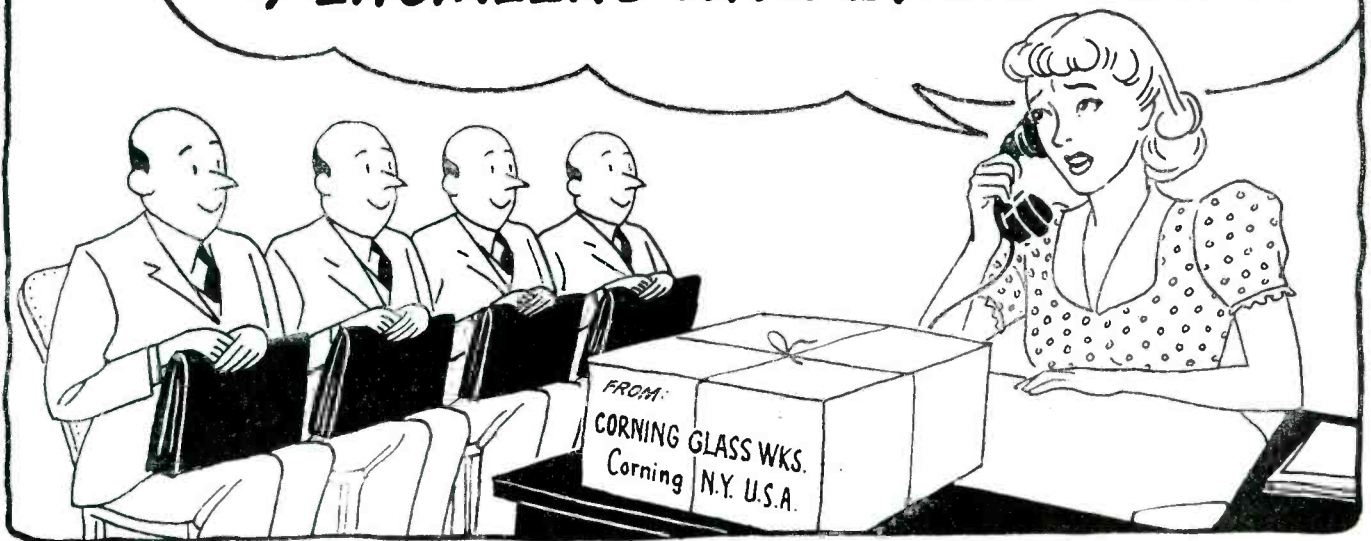

**HOW 4 SPECIAL CORNING SERVICES
CAN SAVE YOU LOTS OF GRIEF!**

IT'S quite a job getting a new electronic product into production. Materials, methods and prices buzz around your head like a bunch of bees. But you don't have to solve your problems all alone. For Corning has four special engineering services to help you:

1. **Sales Engineers**—To keep you in touch with latest developments and explain your problems to Corning's technical experts for prompt solution.
2. **Product Engineers**—Technical men who translate Corning Research in Glass into practical applications which may solve your particular headaches.
3. **Plant Engineers**—These men are anxious to see you get the best possible price on your order. They often point out changes in design which reduce costs.

4. **Technical Service Engineers** — These men get you started right. They help your people lick the production bugs.

Of course, Corning Electronic Glassware also means thousands of glass formulae so you can get the right one for your job. It means Corning's unique metallizing process forming a permanent bond between glass and metal. Tubes, bushings, headers, etc., can be soldered in place to form permanent hermetic seals. It means an entire plant at Bradford, Pa., devoted exclusively to the manufacture of electronic specialties quickly, in large quantities. To get the fastest service in solving your pet problem, write, wire or phone Electronic Sales Department, E-12, Technical Products Division, Corning Glass Works, Corning, New York.

Note—The metallized Tubes and Bushings, Headers and Coil Forms below are all made by the famous Corning Metallizing Process. Can be soldered into place to form true and permanent hermetic seals. Impervious to dust, moisture and corrosion.



Metallized Tubes for resistors, capacitors, etc. 20 standard sizes $\frac{1}{8}$ " x 2" to $1\frac{1}{4}$ " x 10". Mass-produced for immediate shipment.



Metallized Bushings. Tubes in 10 standard sizes, $\frac{3}{16}$ " x $\frac{35}{64}$ " to 1" x $4\frac{1}{32}$ " in mass production for immediate shipment.



Headers—The best way to get a large number of leads in a small space for assembly in one operation.

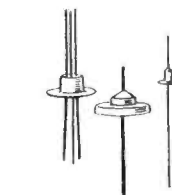

Eyelet Terminals—Single or multiple eyelets permit design flexibility. Standard items readily available in quantity.

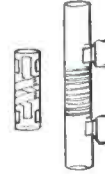

Coil Forms—Grooved for ordinary frequencies—metallized for high frequencies. In various designs and mountings.



VYCOR Brand cylinders—very low loss characteristics. Stands thermal shock up to 900°C. Can be metallized.

CORNING
— means —
Research in Glass

Electronic Glassware



"PYREX", "VYCOR" and "CORNING" are registered trade-marks and indicate manufacture by Corning Glass Works, Corning, N. Y.

LOUD SPEAKERS

BY
Jensen

WHERE
QUALITY
IS ESSENTIAL

*Designers and
Manufacturers of
Fine
Acoustic Equipment*

COMING
ATTRACTIONS



Jensen
SPEAKERS WITH

ALNICO 5

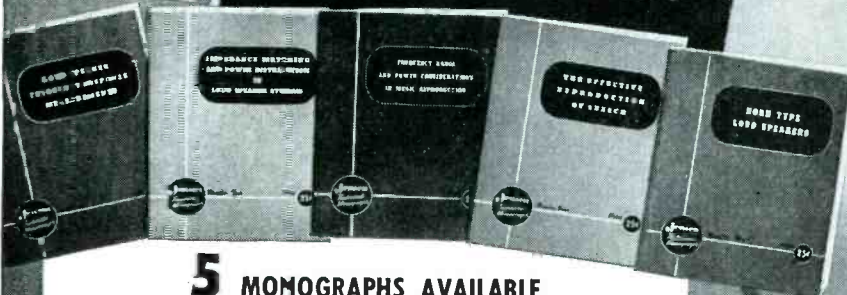

5 MONOGRAPHS AVAILABLE

1. Loud Speaker Frequency-Response Measurements
2. Impedance Matching and Power Distribution.
3. Frequency Range in Music Reproduction.
4. The Effective Reproduction of Speech.
5. Horn Type Loud Speakers.

25c
Each

FREE to the Armed Forces, Colleges, Technical Schools, Libraries.

JENSEN RADIO MANUFACTURING COMPANY • 6607 SOUTH LARAMIE AVENUE, CHICAGO 38, ILLINOIS
IN CANADA—COPPER WIRE PRODUCTS, LTD., 137 RONCESVALLES AVENUE, TORONTO

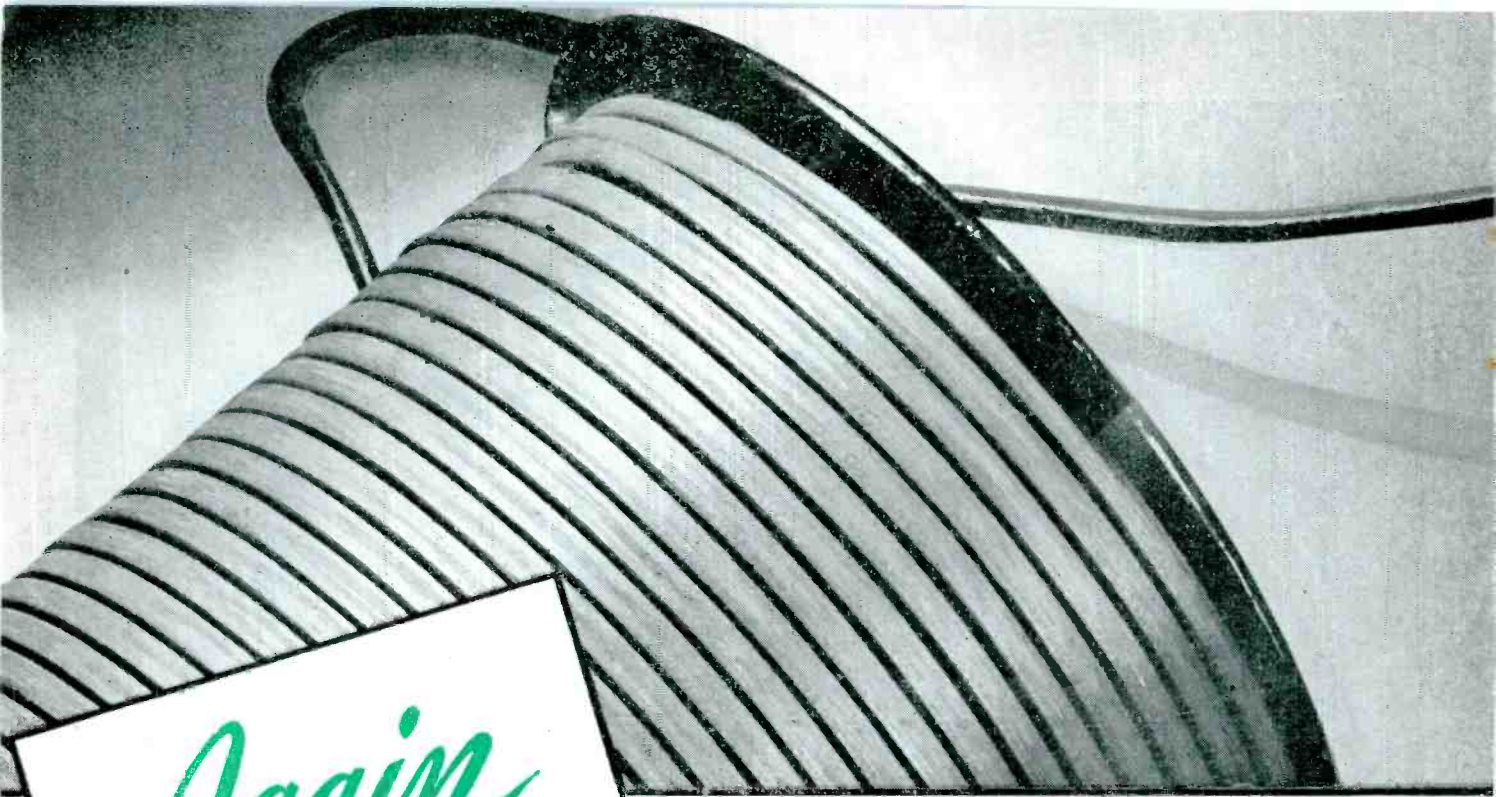

Again

CORDS AND CORD WITH THIS FAMOUS

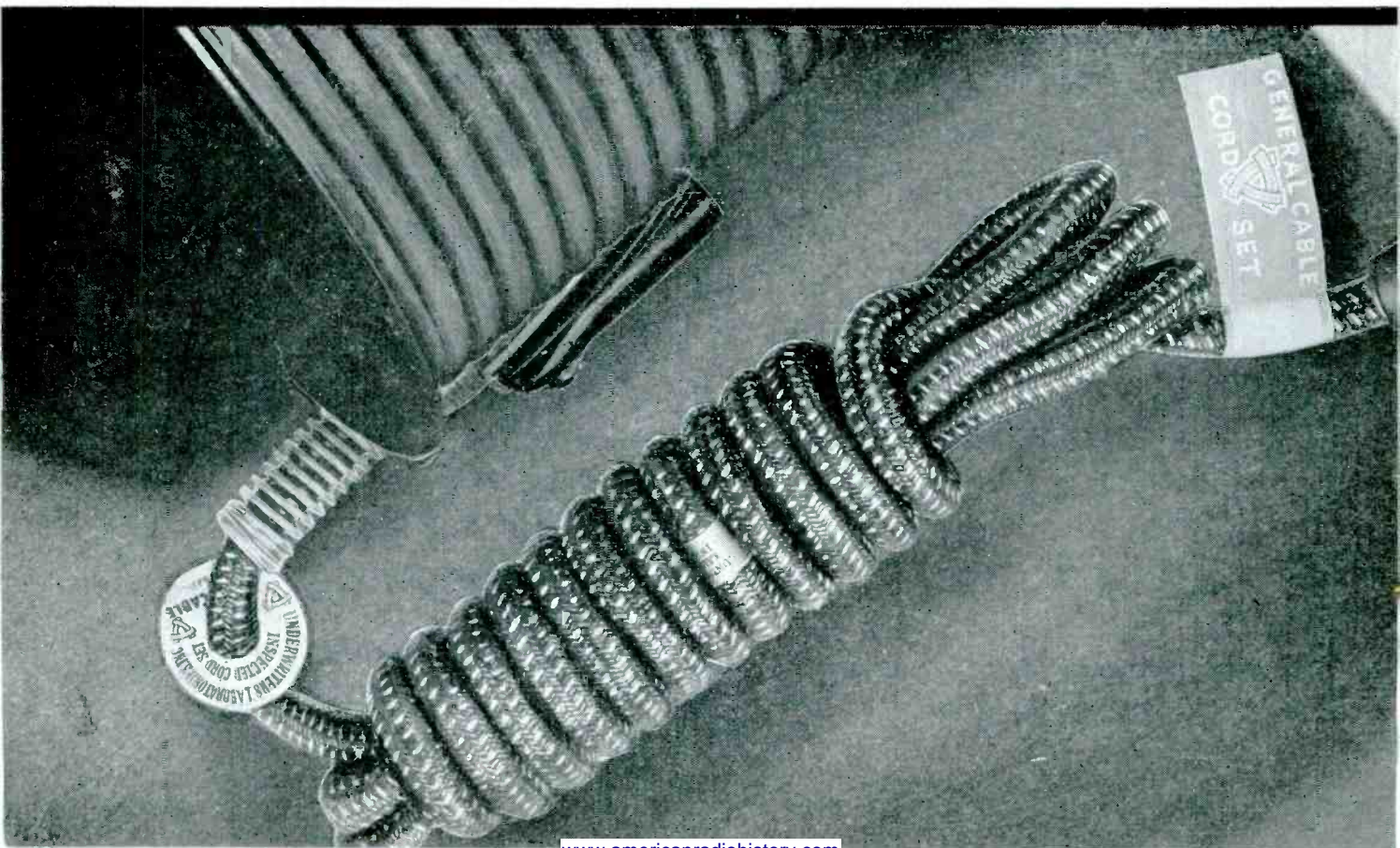

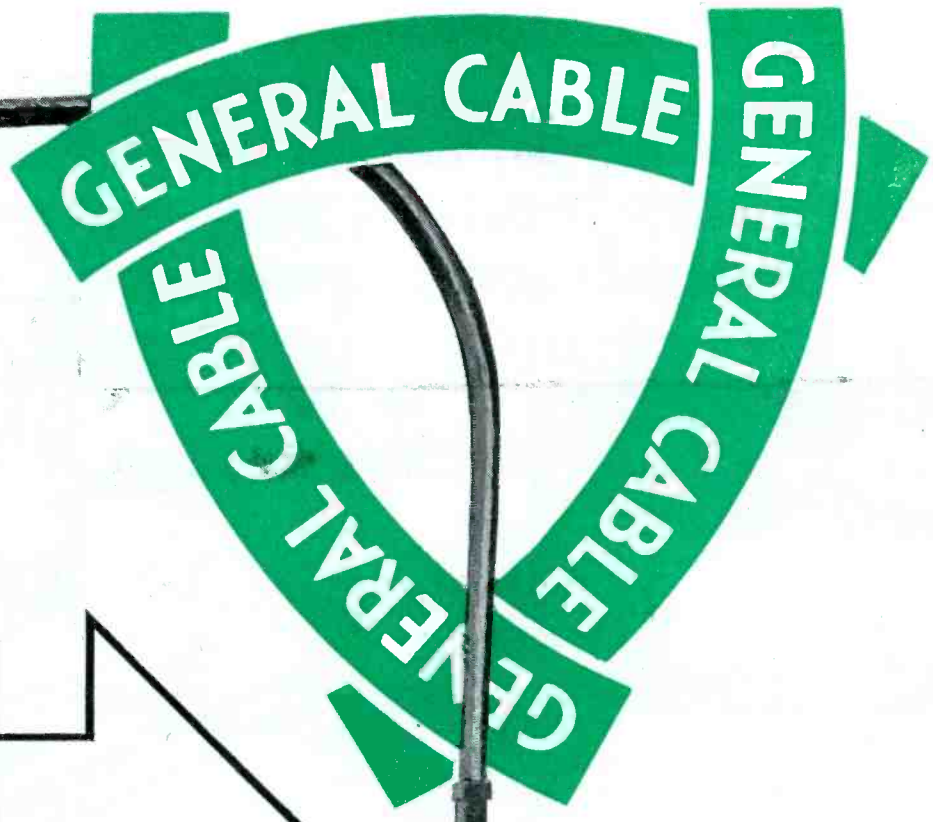

SETS
NAME

This distinguished trade mark in the electrical wire and cable industry is once again the hallmark of quality on Cords and Cord Sets.

General Cable research and advanced engineering, plus expanded facilities and war-developed techniques have been adapted to the production of cords and sets that represent entirely new standards of quality and value.

Whatever your requirements may be, General Cable is now ready to serve you with a complete line of quality cords and cord sets.

GENERAL CABLE
C O R P O R A T I O N



General Cable Corporation Sales Offices are located at Atlanta, Boston, Buffalo, Chicago, Cincinnati, Cleveland, Dallas, Detroit, Houston, Kansas City (Mo.), Los Angeles, New York, Philadelphia, Pittsburgh, Rome (N.Y.), St. Louis, San Francisco, Seattle, Washington (D. C.)

This ISC Flame Cutting Machine is Equipped with Thirteen Clare "Custom-Built" Relays ... accurate, responsive, flexible!

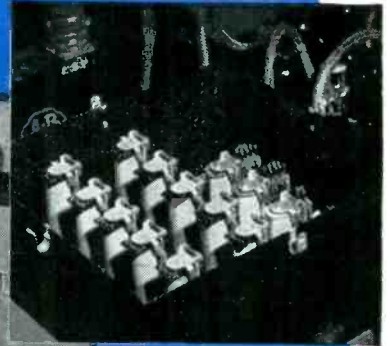
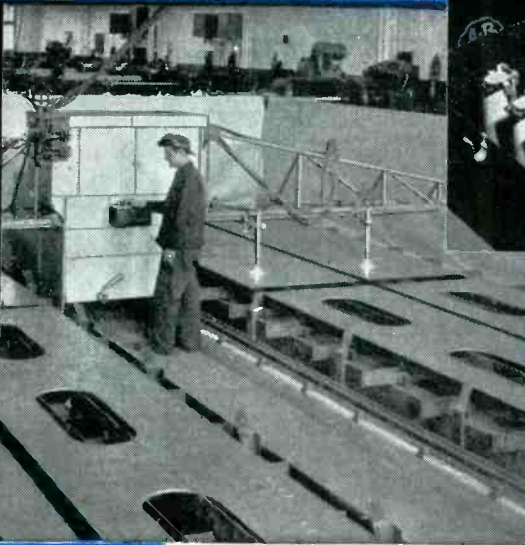
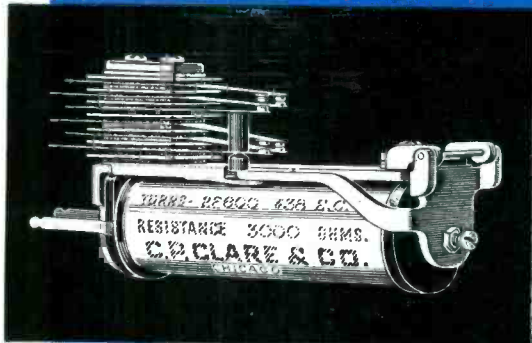

Above: Thirteen Clare "Custom-Built" Relays respond to the electronic impulses to operate Flame Cutting Machine.

Left: Cutting steel plates with ISC Flame Cutting Machine.

• Thirteen Clare "Custom-Built" Relays are used in the operation of this ISC Flame Cutting Machine which is used for oxygen-acetylene burning in shipyards and steel works.

These Clare Relays operate on electronic impulses to start, stop, reverse and jog the 3-phase A. C. motors which connect and disconnect auxiliary circuits for various automatic and manual operations in the cutting process.

This Flame Cutting Machine is a product of the Struthers Wells Corporation of Titusville, Pa., under license of the Industrial Scientific Company of New York City, designers of the machine.

Whether your design problem involves sequence control of machine tools, electric eye controls, counting equipment, alarm systems, radio, radar or other electronic controls, Clare can "custom-build" a relay to meet your exact requirements.

Let Clare engineers know your specific relay problems. Let them show you the wide range of contact arrangements, spring assemblies and special contacts that can be "custom-built" into a Clare Relay to meet your specifications.

Write for the Clare catalog and data book today. It will pay you to know all about Clare "Custom-Built" Relays and what they can mean to you in the reduction of relay costs. Address: C. P. Clare & Co., 4719 West Sunnyside Avenue, Chicago 30, Illinois. Sales engineers in all principal cities. Cable address: CLARELAY.



Contacts are welded to nickel silver springs by special process. May be of precious metals or alloys in 12 different standard, or special, types and sizes.

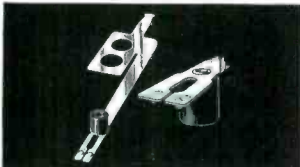

Spring bushing insulators are made of Bakelite rod under patented process. Resist vibration and withstand heavy duty service.



High voltage spring pile-up insulators of special heat-treated Bakelite. Has minimum cold flow properties, low moisture absorption content, and permits punching without cracks or checks.

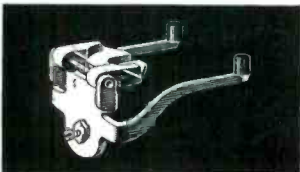

Double arm armature assembly of stainless steel shaft, operating in a marine brass yoke. Heelpiece, core and armature assembly of magnetic metal.

CLARE RELAYS

"Custom-Built" Multiple Contact Relays for Electrical, Electronic and Industrial Use



HERE'S THE HEADLINER

for holding power

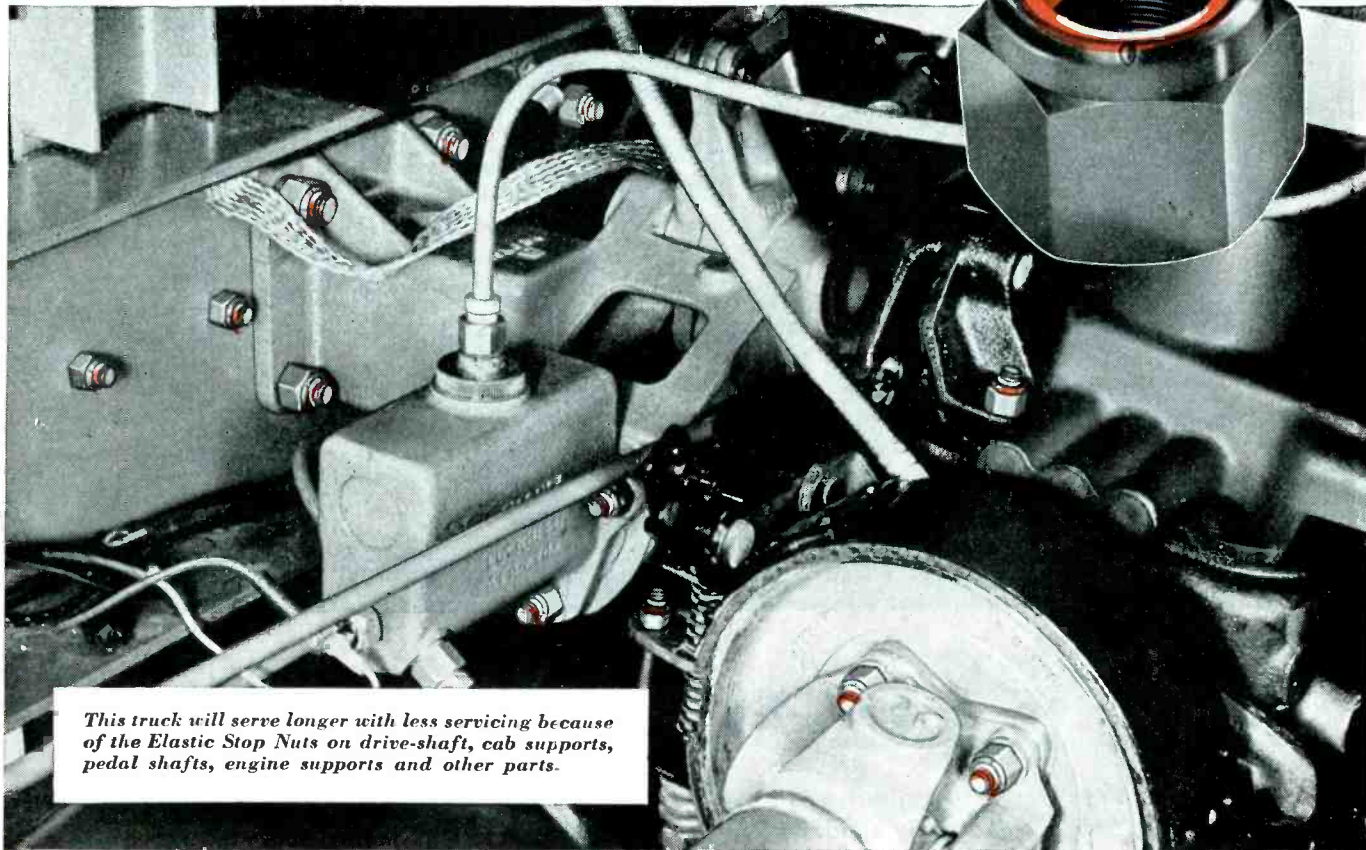

This truck will serve longer with less servicing because of the Elastic Stop Nuts on drive-shaft, cab supports, pedal shafts, engine supports and other parts.

THE ELASTIC *Self-Locking* STOP NUT USES ITS HEAD

Making headline news among sales executives the country over is the Elastic Self-Locking Stop Nut, the nut with the famous red collar.

For sales executives are quick to recognize top-merit features that add sales appeal and widen public acceptance. The nut with the red collar, the hold-fast nut, adds value to trucks, passenger cars, vacuum cleaners, lawn mowers, radios and a host of other things because it assures longer, trouble-free service.

In industry, in the home, in office, factory and on the farm, red-collar nuts are finding thousands of new applications—holding fast wherever

vibration, shock, impact or other loosening influences could cause trouble of any sort, from individual annoyance to multiple fatalities. They simply won't come loose. Not until you take a wrench and deliberately remove them. Then they turn off readily, for the metal threads are sealed-free of rust.

Tough and resilient, the red collar is unthreaded and gauged slightly smaller than the bolt. Bolt threads force their way in, do not cut, and a friction grip is set up. This overcomes the effects of vibration and other loosening forces—and because the collar retains its gripping power, the nuts may be used over and over again.

An application engineer will be glad to call on you and discuss ways Elastic Self-Locking Stop Nuts can help you.

**LOOK FOR THE RED COLLAR
THE SYMBOL OF SECURITY**

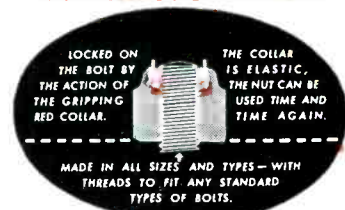

ESNA
TRADE MARK

ELASTIC STOP NUT CORPORATION OF AMERICA

Union, New Jersey

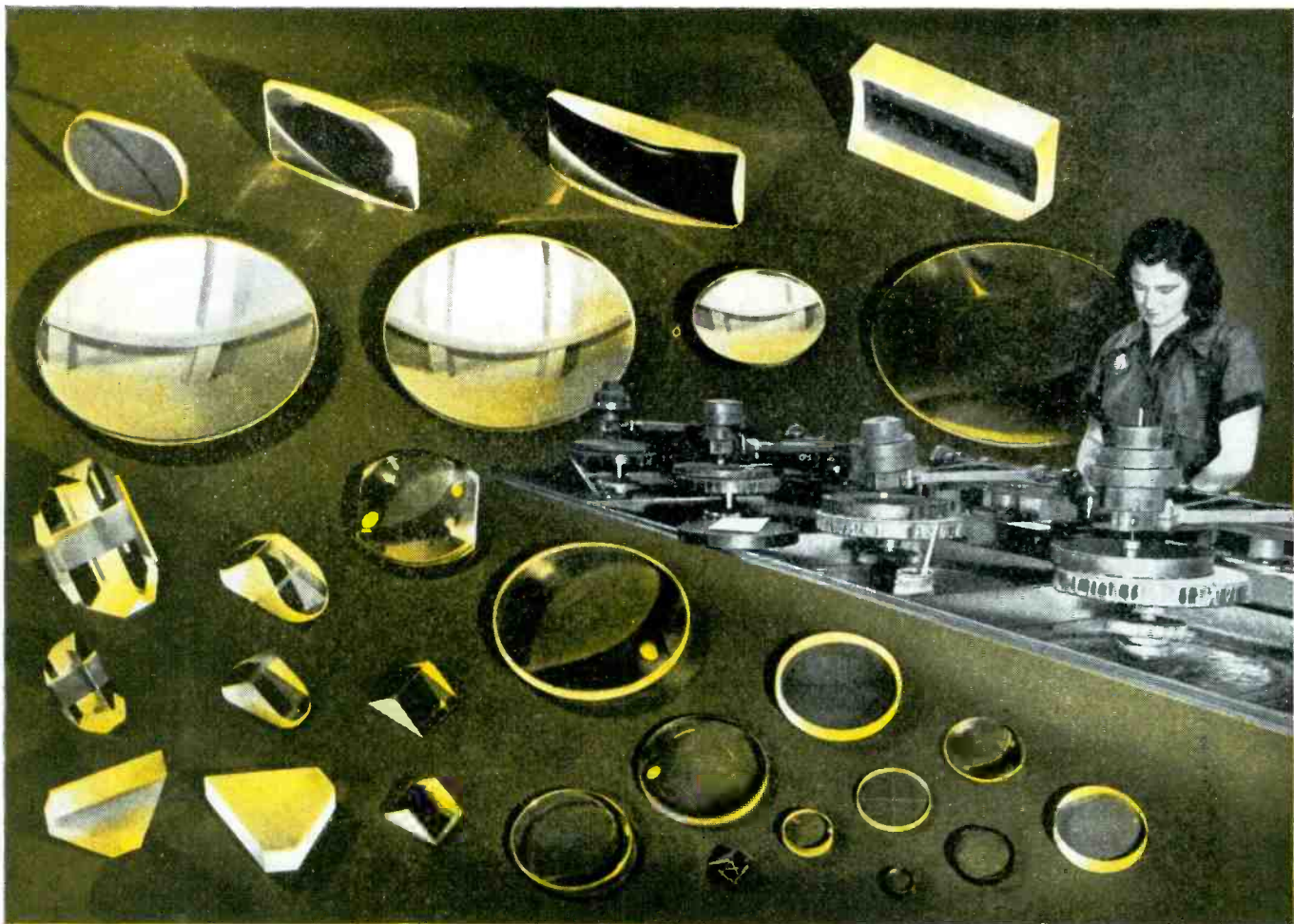

Optics to order—by **AMERICAN** methods

Every component in this picture is as precise as a top-flight craftsman could have made it by hand. But each and every one of them was produced in large quantities. Furthermore, they were all made to order for exacting customers to meet rigid specifications.

Modern machines, of our own improved design, operated and controlled by highly-skilled American workers, enable us to produce precision optics at a high production level. The result is fine quality at a saving.

Our compact group of trained technicians is ready to go to work for a few additional manufacturers. But, as

reconversion progresses, our plant becomes increasingly busy. Those who need optics should readily see the wisdom of making their requirements known to us at an early date so that we can give them the prompt service demanded by these times.

A new booklet, "Precision Optics by American Methods," tells how our company has developed optical manufacturing techniques, why we continue to concentrate all our efforts on the production of precision optics for others, and how we can be of exceptional service to those who need optical components. We shall be pleased to send you a copy of this new booklet on request.

for precision OPTICS come to

AMERICAN LENS COMPANY, INC.

45 Lispenard Street, New York 13, N. Y.



LENSES • • • PRISMS • • • FLATS • • • REFLECTORS

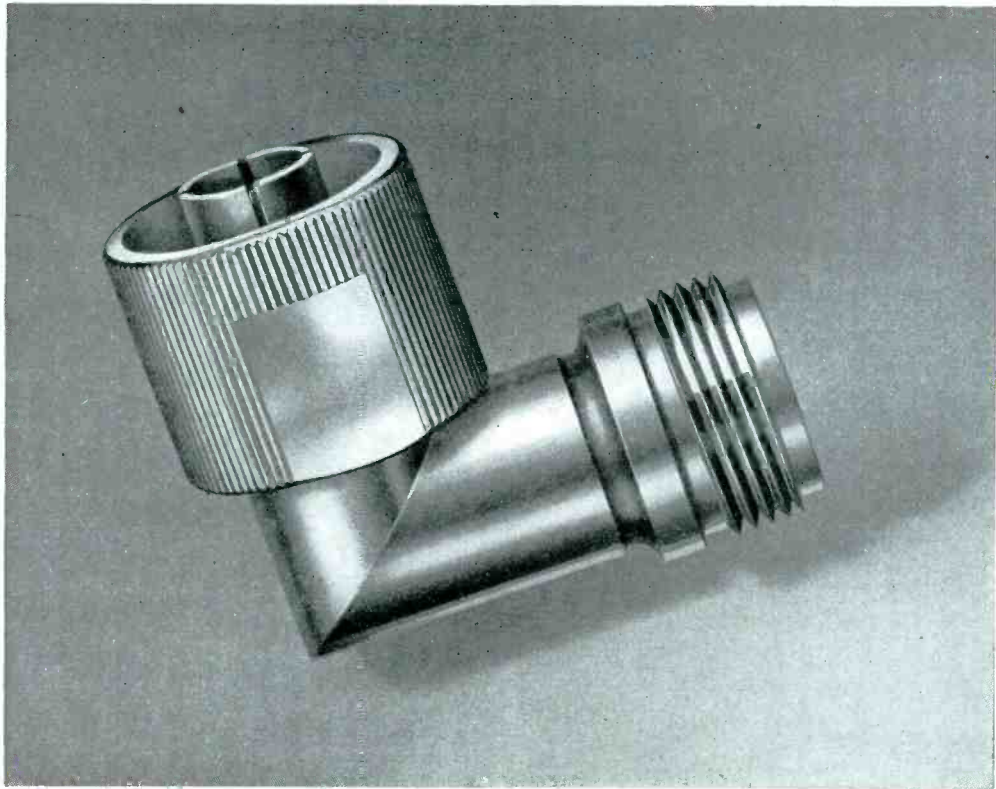

YES, IT'S HERE FOR YOU —

SECTION THROUGH CONNECTOR

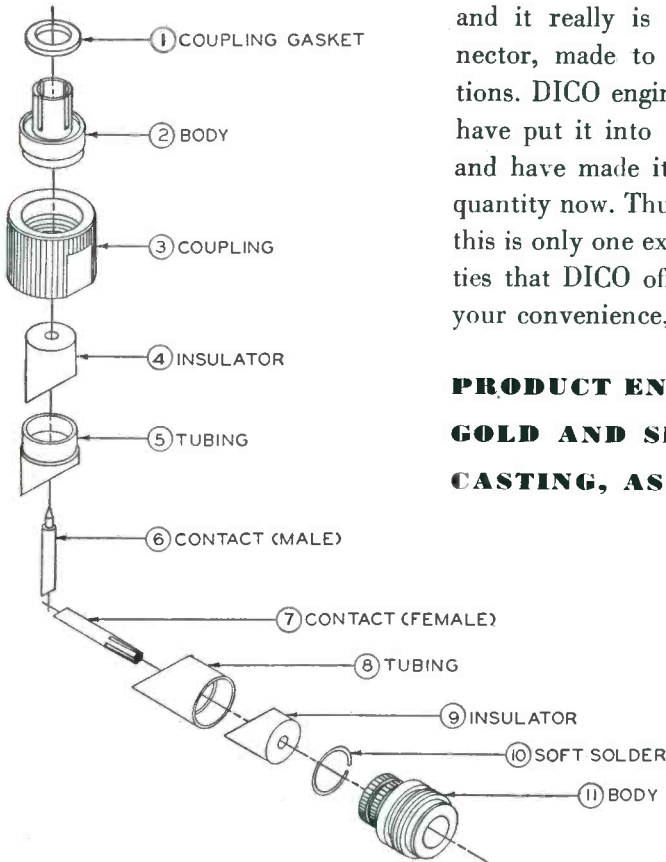
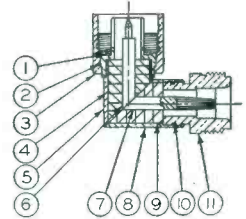

and it really is the UG-27/U angle connector, made to the latest JAN specifications. DICO engineering and technical skill have put it into mass production for you and have made it available for delivery in quantity now. Thus another supposed impossibility has become possible; and this is only one example of what can be done through the unsurpassed facilities that DICO offers you. Our representative will call for consultation, at your convenience, without obligation.

**PRODUCT ENGINEERING, DESIGNING, DEVELOPMENT;
GOLD AND SILVER PLATING; SOLDERING, WELDING,
CASTING, ASSEMBLING, FINISHING.**





Quiet



Efficient—reliable—above all, *QUIET*—
that's the Ballentine Phonograph Drive.

Basic refinements in design, *precision*
dynamic balance, the most advanced
manufacturing technique and equipment make
the Ballentine Phonograph Motor unequalled
for low background noise or rumble.

Send for descriptive bulletin.

RUSSELL ELECTRIC COMPANY

364 WEST HURON ST., CHICAGO 10, ILL.

Manufacturers of

BALLENTINE PHONOGRAPH DRIVE



Light? We call it "LIGHT FANTASTIC"!

... a transformer headed for 65,000 feet "altitude" ... at 350 degrees temperature!

And to top it off, it had to be "lighter than anything on the market," *they said. What, we asked, was it for? They couldn't tell us, and we don't know to this day, but we do know it was badly needed.

"It has to operate not only on a 60-cycle current at ground level, but from 400 to 2600-cycle current, and what's more, at a simulated altitude of 65,000 feet."

Thermador built this special transformer equipment. It passed the above mentioned requirements. That wasn't enough. They gave it another test, in which they changed the temperature from ambient (the temperature of a fairly warm room) to 350—in two hours. It passed that test, too. This is all we know of one of the most mysterious jobs

we ever did, in the not-mysterious method in which we built all of our transformers.

*For reasons of military security names cannot be given.

**THERMADOR
TRANSFORMERS**

DEFEAT HEAT • COLD • HUMIDITY



THERMADOR ELECTRICAL MANUFACTURING CO.
5119 SOUTH RIVERSIDE • LOS ANGELES 22, CALIFORNIA



more efficient
...in miniature



ACTUAL SIZE

The cast iron pump was modern two or three generations ago. It was a big improvement over the old oaken bucket. But today we use a comparatively small faucet that supplies water at a twist of the wrist. It is another milestone on the road to greater efficiency in miniature.

This same tendency is evident in the development of the Electronic Tube. The Tung-Sol Miniature is the result of the trend to smaller component parts. It is used to great advantage in reducing the over-all size of equipment. But more important, Tung-Sol Miniatures do a more efficient job than the old style tube; especially in high frequency circuits. They have a low capacity and high mutual conductance. Shorter leads give them low inductance. Smaller elements weigh

less, making Miniatures more rigid. This helps to eliminate distortion from vibration.

When planning new electronic devices or when improving old ones, discuss circuits and tube selection with Tung-Sol engineers. Their services are at your disposal. Such conferences are held in strictest confidence.

TUNG-SOL
vibration-tested
ELECTRONIC TUBES

TUNG-SOL LAMP WORKS INC., NEWARK 4, NEW JERSEY
Also Manufacturers of Miniature Incandescent Lamps, All-Glass Sealed Beam Headlight Lamps and Current Intermittors

December 1945 — ELECTRONICS



A CLASS "C" INSULATION—
INORGANIC CERAMIC—
APPROXIMATELY 1/4 MIL THICK—
PERMITS CONTINUOUS
OPERATION AT 200°C.

THE WIRE INSULATION

... that will not burn!



Sprague CEROC 200 is an inorganic, non-inflammable ceramic wire coating supplied in a preferred thickness of only 1/4 mil and holding vast opportunities for smaller size and lighter weight with greatly increased power for a wide variety of electrical equipment. By using it, mid-gig size windings can be made to do man-size jobs—with safe, conservative operation up to 200°C. if necessary. Space factor is higher than that of any other type of wire insulation and, despite its ceramic nature, CEROC 200 can readily be wound to meet most requirements.



MIDGET-SIZE WINDINGS
DO MAN-SIZE JOBS!

Write for copy of CEROC 200 Bulletin 505

SPRAGUE ELECTRIC CO., NORTH ADAMS, MASS.



SPRAGUE

Ceroc 200

(*Trademark Reg. U. S. Patent Office)

Pioneered and Produced by the Makers of SPRAGUE CAPACITORS and *KOOLOHM RESISTORS

USE STANDARD PARTS—SAVE TIME AND MONEY



EXPERIENCE

For many years

*Automatic has manufactured
Coils and Trimmers for manufacturers.*

*Our mass-production methods
will save you money and headaches.*

*Order your Coils and Trimmers from
people who "know how".*



AUTOMATIC
MANUFACTURING
CORPORATION

MASS PRODUCTION COILS & MICA TRIMMER CONDENSERS

900 PASSAIC AVE.

EAST NEWARK, N. J.

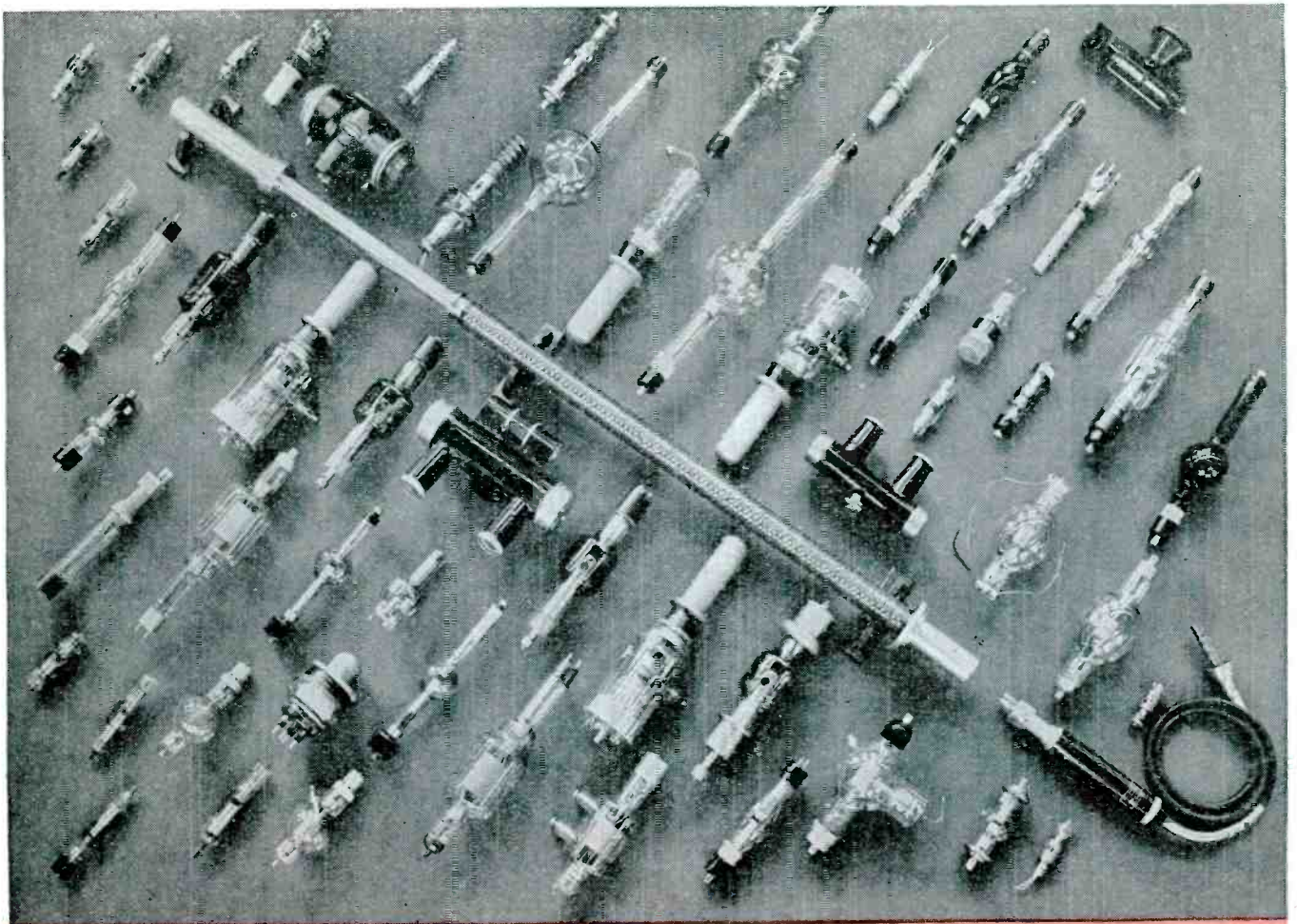

GROUPED about the widely acclaimed Two-million-Volt Precision X-ray Tube are other Machlett tubes for medical, industrial and radio purposes. In each of these tubes are incorporated the inherent skills employed by Machlett in the development of this unique tube. They are your assurance of long life, ruggedness and dependability in whatever field they are used. Machlett Laboratories, Inc., Springdale, Connecticut.

MACHLETT

APPLIES TO RADIO AND INDUSTRIAL USES
ITS **40** YEARS OF ELECTRON-TUBE EXPERIENCE

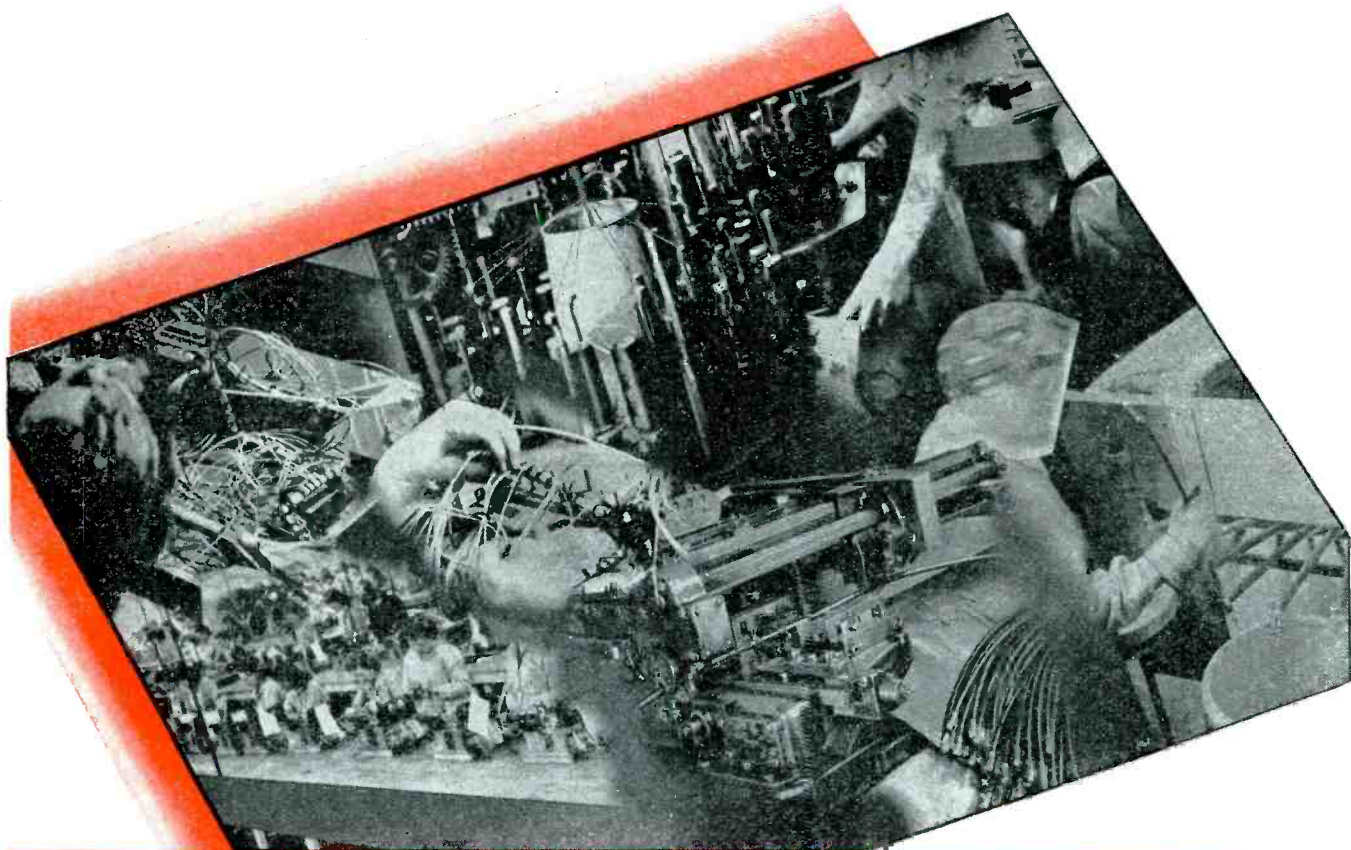

ENGINEERED CABLE ASSEMBLIES at a fixed production cost to you

If your product requires WIRING HARNESSES... CABLE ASSEMBLIES... BONDING JUMPERS... CABLE or TERMINALS—you'll find that a lower cost of manufacturing, at a fixed production cost to you, is one of many advantages Whitaker offers you.

In turning the production of your wiring requirements over to us you are assured quality merchandise made to the most exacting speci-

fications. When your men install the completed assemblies they will find every lead and every terminal properly positioned for the right connection. The economies gained will be big factors in enabling you to lower your cost of manufacturing.

In addition to an engineered wiring service, Whitaker also offers a quality line of standard cable products... Write for latest catalog, and complete information.

*Whitaker
Can
Wire It*

WHITAKER CABLE CORPORATION

General Offices: 1307 Burlington Avenue, Kansas City 16, Missouri
Factories: Kansas City, Mo. • St. Joseph, Mo. • Philadelphia • Oakland

Don't let **INSULATION** be the **WEAK LINK** in your product

Read this paragraph

from **ELECTRICAL MANUFACTURING**, AUGUST, 1945, page 212

However, cellulose acetate insulation cannot be overlooked, particularly for low temperature coils exposed to severe humidity conditions. Cellulose acetate is one of the few insulating materials that will not ionize and attack the copper magnet wire in the presence of moisture so that it plays an important role in the insulation of extremely small magnet wire coils.

Lumarith CA has these additional advantages:

- high dielectric strength
- resistance to salt water
- resistance to mildew and fungus
- resistance to transformer oils
- high arc resistance

Use Lumarith films and foils for interlayer insulation, inter-phase insulation, slot insulation, coil wraps and covers, laminates, wire insulation. Special A78 mat finish (one side) can be supplied.

Use Lumarith sheets, rods, tubes and molding materials for coil forms, separators, bus bar insulation, radio and instrument housings, fluorescent lighting parts, formed insulators, bezels, coil supports, nameplates, switch gear windows.

Lumarith CA is a product of Celanese research. Write for latest Celanese electrical booklet. Celanese Plastics Corporation, a division of Celanese Corporation of America, 180 Madison Avenue, New York 16, N. Y.

ELECTRICAL PARTS and products from the smallest size to the largest, can be effectively protected against electro-chemical corrosion by use of Lumarith CA (cellulose acetate) insulation.

Lumarith CA is available in these forms:

- films, foils and sheets
- extruded rods and tubes
- molding materials for injection and extrusion

LUMARITH* CA

A C E L A N E S E * P L A S T I C

*Reg. U. S. Pat. Off.

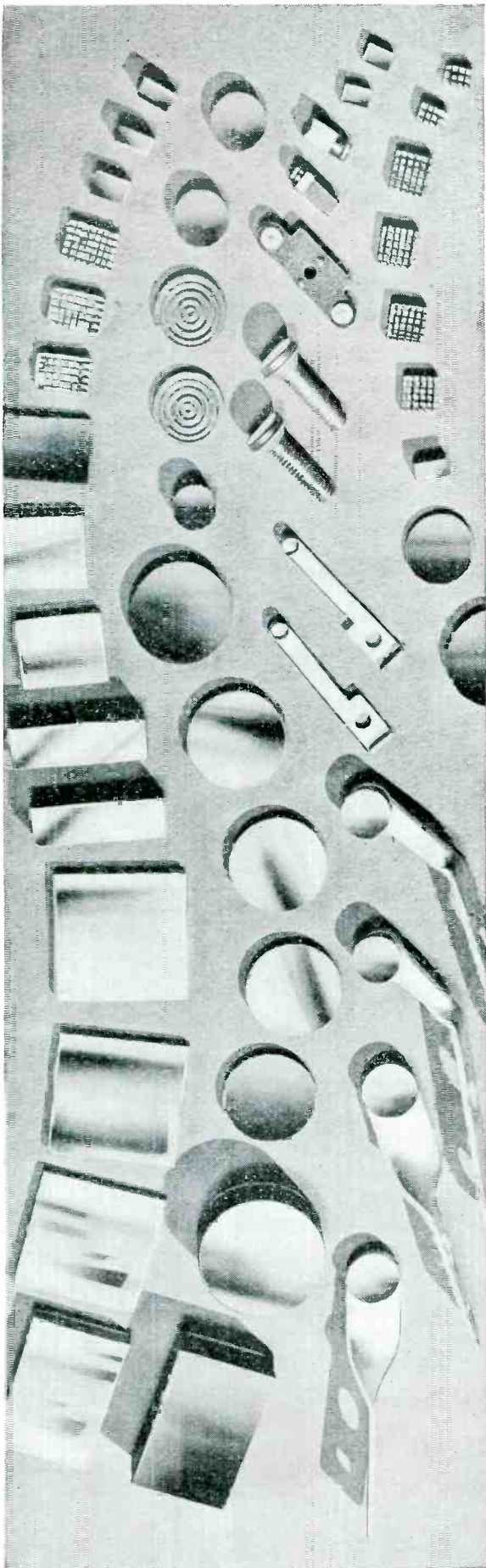

Wilcoloy

(SINTERED POWDER METAL CONTACTS)

WILCOLOY offers Longer Contact Life . . . Greater Resistance to Interrupting Loads, and many other advantages for high current applications.

PROPERTIES AND CHARACTERISTICS—WILCOLOY Silver Tungsten, Copper Tungsten, Silver Graphite, Silver Molybdenum and other WILCOLOY contact materials assure a degree of longevity, and thermal and electrical properties not possible to materials previously used in applications subject to severe current interruptions.

These Sintered Powder Metal Contacts offer a choice of properties including ductility, hardness, density, freedom from sticking, low metal transfer, high conductivity and arc-resistance. They perform uniformly and dependably in heavy duty circuit breakers, both air and oil relays, aircraft units, motor brushes, commutator segments, fuse replacement units and other specialized applications.

CONSULT OUR ENGINEERING DEPARTMENT— Write our Engineering Department for help in developing the proper application of WILCO materials to your products.

SEND FOR WILCO BLUE BOOK—The Blue Book contains descriptions of most WILCOLOY Sintered Powder Metal Contacts and other WILCO products. Send for FREE copy today.

WILCO PRODUCTS INCLUDE:

CONTACTS—

Silver
Platinum
Tungsten
Alloys
Sintered Powder Metal

THERMOSTATIC BIMETAL—

All Temperature ranges,
deflection rates and electrical
resistivities.

**PRECIOUS METAL COLLECTOR
RINGS—**

For rotating controls

SILVER CLAD STEEL—

JACKETED WIRE—
Silver on Steel, Copper,
Invar or other combinations
requested.

ROLLED GOLD PLATE

SPECIAL MATERIALS



THE H. A. WILSON COMPANY

105 Chestnut Street, Newark 5, N. J.

Branch Offices: Chicago • Detroit • Los Angeles

**SPECIALISTS FOR 30 YEARS IN THE MANUFACTURE OF THERMOMETALS
ELECTRICAL CONTACTS • PRECIOUS METAL BIMETALLIC PRODUCTS**

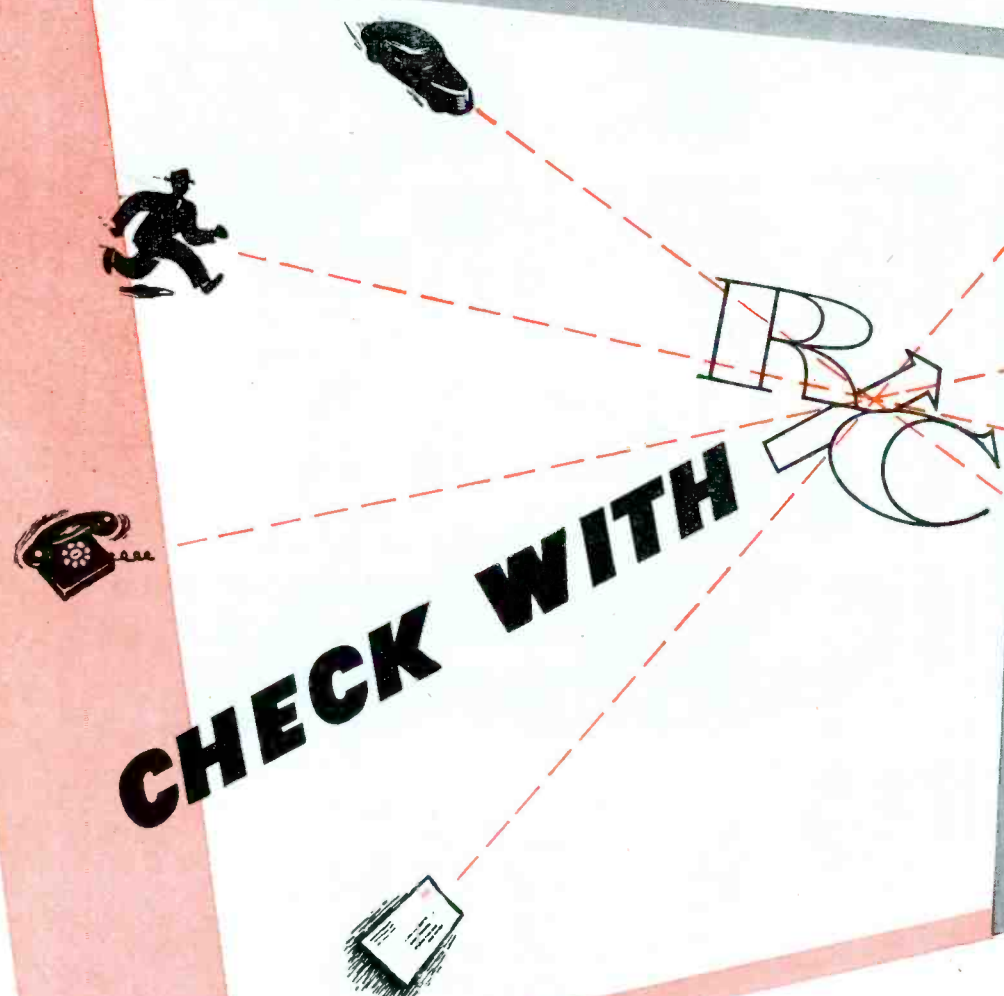

CHECK WITH

R/C

GENERAL OFFICE:

Radio Condenser Co.
Davis & Copewood St.
Camden, N. J.

Radio Condenser Co.,
Ltd.
1010 Dufferin St.
Toronto 4, Ontario,
Canada

Radio Condenser Co.
4447 Armitage Ave.
Chicago 39, Illinois

Radio Condenser Co.
3415 W. 8th Street
Los Angeles 5, Cal.

Radio Condenser Co.
420 Lexington Ave.
New York 17, N. Y.

Radio Condenser Co.
Export Department
15 Moore Street
New York 4, N. Y.

**... when Variable Capacitor
KNOW-HOW makes a difference!**

We design and build **ONLY** variable capacitors and mechanical tuning devices.

This factor, more than any other, has contributed to the high degree of R/C specialized knowledge in the field of variable capacitor design and manufacture.

With a history of almost a quarter of a century as suppliers to the set manufacturing industry, Radio Condenser Company offers the most complete engineering background in variable capacitors and mechanical tuning devices.

RADIO CONDENSER COMPANY
CAMDEN, N. J.
RADIO CONDENSER CO., Ltd., Toronto, Canada

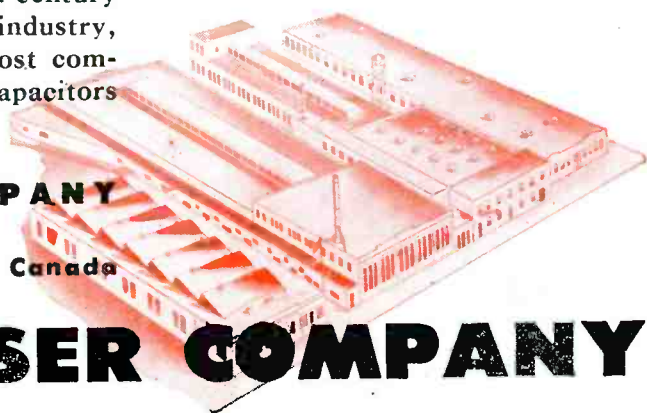

RADIO CONDENSER COMPANY

SUPPLIERS TO SET MANUFACTURERS ONLY

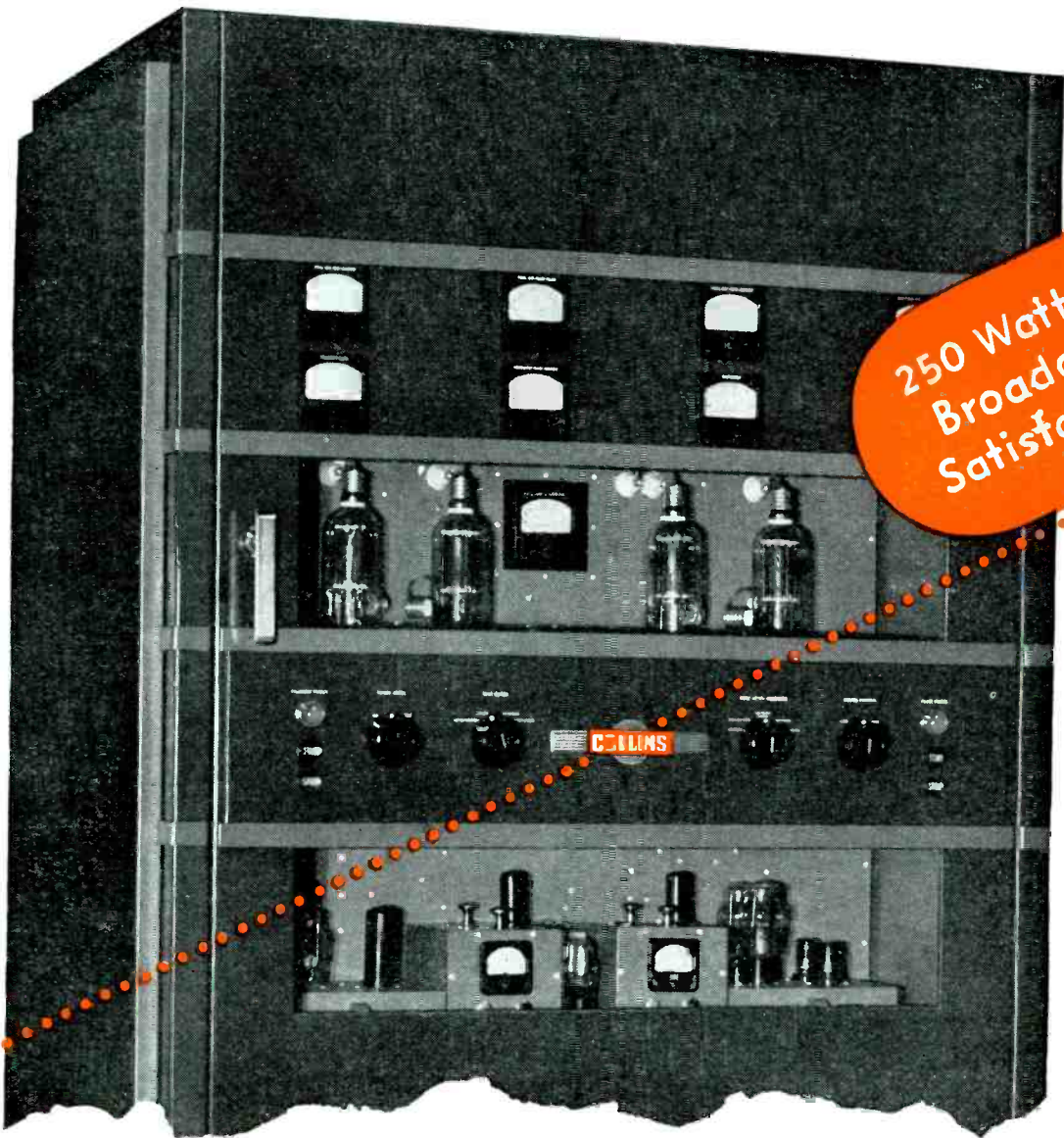

250 Watts of
Broadcast
Satisfaction

**Collins 12Z
Remote Amplifier**

A high quality four channel remote amplifier, a.c.-d.c. powered. The d.c. source consists of self-contained batteries which take the load automatically in case of a.c. line failure. Gain, approximately 95 db. Frequency response, 30-12,000 c.p.s. = 1 db. Power output, 50 milliwatts. Weight, with batteries and carrying case, 32 pounds.



The new Collins 300G-1 AM broadcast transmitter is an operator's ideal.

Its components are the finest available, with very high safety factors, and all are completely and immediately accessible. Replacements, if necessary, are just a quick, simple one-man job!

Circuit design, physical arrangement, and workmanship throughout, meet the superior standards which station engineers have come to expect of Collins engineering.

The nominal power output of the 300G-1, 250 watts, can be reduced to 100 watts by means of a switch on the control panel. The response is flat within ± 1.0 db from 30 to 10,000 cycles. Distortion is less than 3% up to 100% modulation.

Tell us about your plans. We will be glad to study them with you and make recommendations covering requirements for your entire station, AM or FM, and of any power. Collins Radio Company, Cedar Rapids, Iowa; 11 West 42nd Street, New York 18, N. Y. In Canada, Collins equipment is sold by Collins-Fisher Limited, Montreal.

FOR BROADCAST QUALITY, IT'S . . .



Available now!

RADACOR IRON CORES

precision —

produced!

Magnetic Iron Cores, subjected to rigorous tests and designed for use at all frequencies including television and FM, are now available. Our engineering staff will be glad to assist you in determining which of these components can best satisfy your requirements.

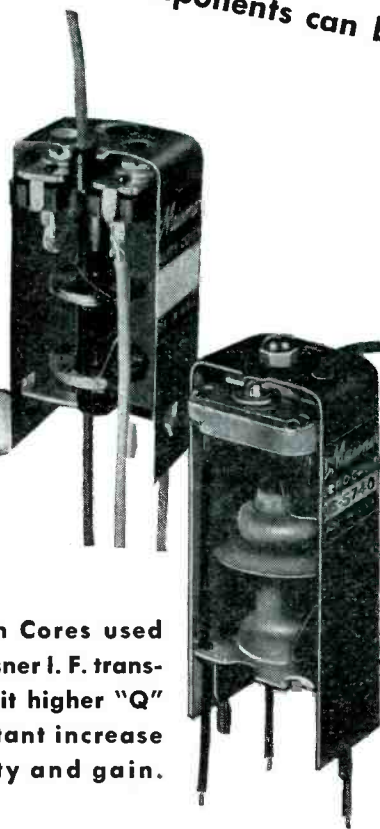

Radacor Iron Cores used in these Meissner I. F. transformers permit higher "Q" with a resultant increase in selectivity and gain.

ELECTRONIC & MECHANICAL POWDER METALLURGY

MICRO-FERROCART PRODUCTS

DIVISION

MAGUIRE INDUSTRIES, INC.
STAMFORD, CONN.

MORE POWER OUTPUT **BUT** LESS BATTERY DRAIN WITH HYTRON INSTANT-HEATING BEAM TETRODES

ZERO STAND-BY CURRENT Thoriated tungsten filaments of the Hytron 2E25, HY69, and HY1269 permit simultaneous application of all potentials. During stand-by, no precious filament current is drawn from the battery. Especially with the larger tube complements of FM transmitters, is conservation of battery power mandatory.

MORE OUTPUT—GREATER RANGE Only 4% of the current required for cathode types, is necessary to operate the instant-heating 2E25, HY69, and HY1269. (See table below.) Even in a mobile FM transmitter, 100 watts output is practicable. Imagine the advantages of such increased output in police, marine, or other mobile equipment.

SPARES PROBLEM SIMPLIFIED Using the 2E25, HY69, and HY1269, you take full advantage of the beam tetrode's versatility. The 2E25, for example, can power a whole transmitter—AF and RF—AM or FM. If more output is required, HY69's or HY1269's in push-pull still confine the spares complement to only two types.

ADVANTAGES OVER CATHODE TYPES Yes, the 2E25, HY69, and HY1269 cost more than cathode types. But they are worth it. Not only are they easier on the battery, and permit larger outputs, but they are designed, built, and tested for transmitting. Some advantages are: centering of filament potential at 6.0 volts, r.f. shielding to eliminate the necessity for neutralization, low-loss insulation throughout, plate connection to top cap, and rugged construction.



BATTERY DRAIN OF A CONVENTIONAL TRANSMITTER AND KAAR FM-50X EQUIPPED WITH HYTRON INSTANT-HEATING TUBES

	Conventional 30 watt	KAAR FM-50X - 50 watt
AMPERE HOURS:	0 10 20 30 40 50 60 70	
STANDBY DRAIN 24 HOUR PERIOD	55.2 AMPERE HOURS	0.0 AMP. HRS.—YET READY TO TALK INSTANTLY!
AVERAGE TOTAL BATTERY DRAIN 24 HOUR PERIOD	56.8 AMPERE HOURS	2.2 AMPERE HOURS

This chart, prepared by Kaar Engineering Co., is based on typical metropolitan police use of 140 radiotelephone-equipped cars operating three shifts in a city of 600,000 population. The 24-hour survey included 904 messages originated by cars and 932 messages acknowledged by cars. Transmissions averaged: 13 per car, 15 seconds in length, and 3 minutes 15 seconds transmitting time.

ABBREVIATED DATA HYTRON INSTANT-HEATING BEAM TETRODES

Characteristic	2E25	HY69	HY1269
Filament Potential (volts)	5.0	6.0	6/12
Filament Current (amps.)	0.8	1.5	3.2/1.6
Plate Potential (max. volts)	450	600	750
Plate Current (max. ma.)	75	100	120
Plate Dissipation (max. watts)	15	30	30
Grid-to-Plate Capacitance (mmfd.)	0.25	0.25	0.25
Maximum Seated Height (inches)	3 5/8	5 1/4	5 1/4
Maximum Diameter (inches)	1 7/16	2 1/16	2 1/16
Class C Power Output (watts)	24	42	65
Class C Driving Power (watts)	Less than one watt		



OLDEST MANUFACTURER SPECIALIZING IN RADIO RECEIVING TUBES

HYTRON

RADIO AND ELECTRONICS CORP.



MAIN OFFICE: SALEM, MASSACHUSETTS

101 SERIES

Amplifiers

WITH RACK PANEL OR WALL
MOUNTING ACCESSORIES



Input impedance 600 ohms and bridging. Gain 600 ohm input 61 db., bridging input 46 db. Frequency response 30 to 16,000 c.p.s. either input—600 ohm output ± 5 db., 30 ohm output ± 1 db. Power output—production run average: +47 V.U. with less than 3% RMS harmonic content.

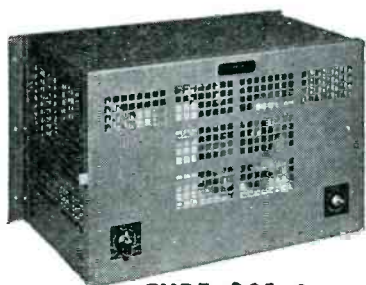

TYPE 201-A Wall Mounting Cabinet permits universal installation of 101 Series Amplifiers to any flat surface. Well ventilated and designed for maximum accessibility for servicing and convenience of installation. Standard aluminum gray finish.



TYPE 7-A Modification Group permits 101 Series Amplifiers to mount on standard 19" telephone relay racks. Occupies 12 1/4" rack space. Allows servicing from front of rack. Standard aluminum gray finish.

THE TYPE 101 Series Amplifiers are the results of twenty years' experience in the sound engineering field. They are identical with the exception of the output coil.

Type 101-A has output impedance adjustments to match loads from 1 to 1000 ohms and possesses excellent low frequency waveform at high output levels.

Type 101-B with a single nominal 6 ohm output is intended for use with wide range loudspeakers representing an 8 to 16 ohm load. Its output coil with a single secondary provides improved efficiency and even better waveform at high levels of low frequencies.

Type 101-C answers the demand for a good amplifier at lower cost. This lower cost is obtained by the use of a less expensive output coil with the only change being that the low frequency waveform is not as good as the A or B types but is equal to or better than any contemporary commercial amplifier. Output impedance is adjustable to loads of 1 to 1000 ohms.

The Langevin Company

INCORPORATED

SOUND REINFORCEMENT AND REPRODUCTION ENGINEERING

NEW YORK

37 W. 65 St., 23

SAN FRANCISCO

1050 Howard St., 3

LOS ANGELES

1000 N. Seward St., 38

www.americanradiohistory.com

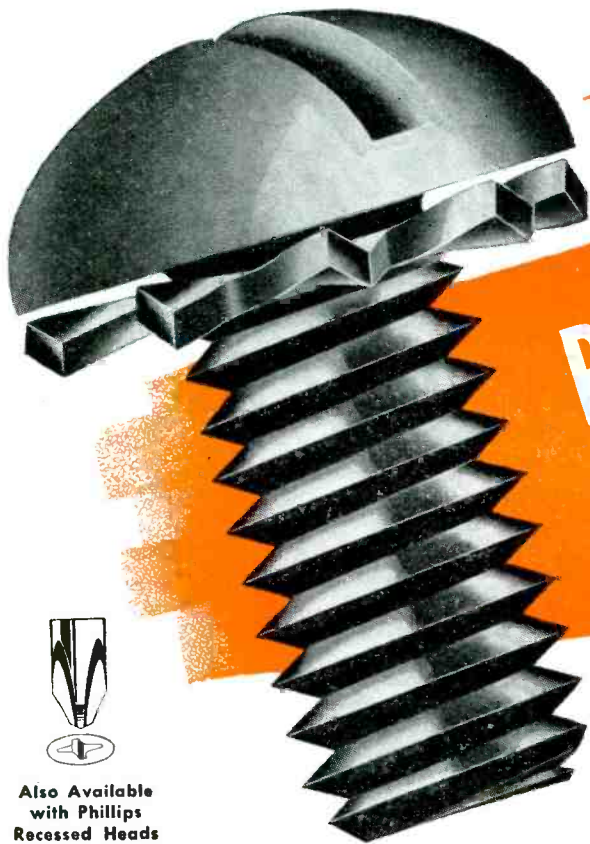

Pre-Assembled
TO REDUCE
YOUR COSTS!



Also Available
 with Phillips
 Recessed Heads

SEMS

Trademark Reg. U. S. Pat. Off.

FASTENER UNITS

**PRE-ASSEMBLED SHAKEPROOF
 LOCK WASHER AND SCREW**

**HERE ARE FOUR WAYS
 SEMS UNITS SAVE
 TIME AND MONEY**



No time wasted putting a lock washer on a screw. Sems are delivered as a single unit—ready for immediate installation.



No dropped or lost lock washers. The lock washer on a Sems Fastener Unit can't drop off—but is free to rotate.



Easy to use in hard-to-reach parts. Sems Units assure fast assembly and there's no chance to "forget" the lock washer.



The right type and size lock washer for each connection. Important too, every Sems Unit includes a Shakeproof Lock Washer with Exclusive Tapered-Twisted Teeth.

Assemblers simply pick up a Sems Fastener Unit and drive it! No need to put a lock washer on a screw because the Sems Unit is a combination of both. Thus an entire operation is eliminated . . . assembly speeds up, costs speed down.

Learn now—right on your own assembly line—the multitude of advantages that this modern fastening method offers you.

Shakeproof Engineers will analyze your particular fastening applications, recommend the correct type and size of Sems Unit and show your workers how they can easily and quickly reduce motions and gain vital assembly time. Ask for this special service today . . . a Shakeproof field engineer is ready to give you the benefit of his extensive fastening knowledge.

*Get a Free Sems Fastener Unit Sample Test Kit
 —Write for Kit No. 23*

SHAKEPROOF inc.
"Fastening Headquarters"

Distributor of Shakeproof Products Manufactured by ILLINOIS TOOL WORKS
 2501 North Keeler Avenue, Chicago 39, Illinois
 Plants at Chicago and Elgin, Ill. In Canada: Canada Illinois Tools, Ltd., Toronto, Ont.
 Los Angeles Office Detroit Office
 5670 Wilshire Blvd., Los Angeles 36, Calif. 5895 E. Grand Blvd., Detroit 2, Mich.

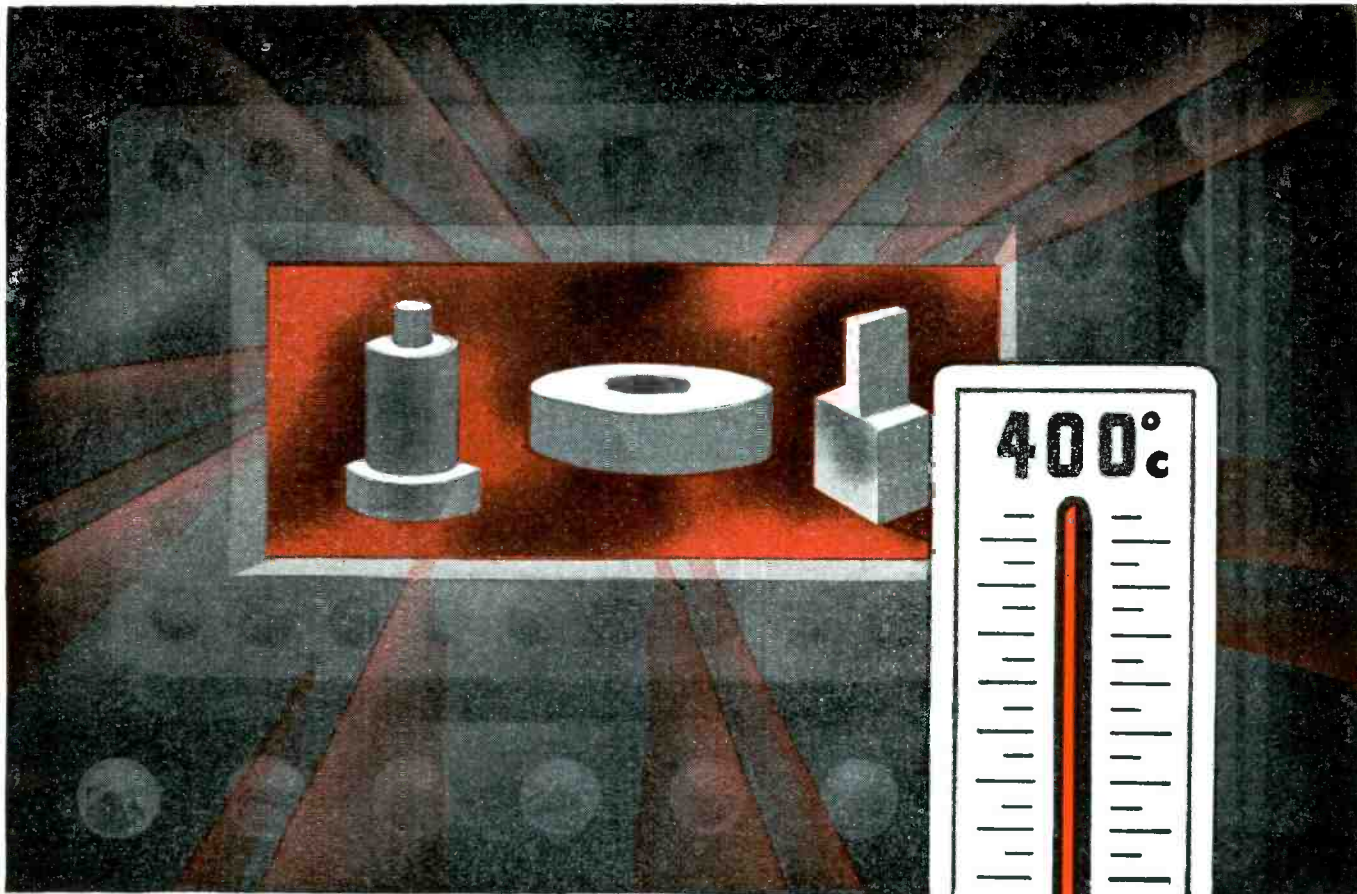

MYCALEX 400

WITHSTANDS HIGH TEMPERATURES

An outstanding characteristic of MYCALEX 400 is that it can withstand temperatures above 400° C. without softening or any permanent change in dimensions or properties.

Thus MYCALEX 400 has proved of great value as a low loss insulator in communications and other high frequency apparatus intended for use at elevated operating temperatures.

MYCALEX 400 is inorganic, free of carbonization... impervious to oil and water... not subject to cold flow. It meets all Army and Navy specifications as Grade L-4 material (JAN-I-10). It combines low loss factor with machinability to close tolerances. In sheets and rods. Fabricated to specifications.



OTHER MYCALEX CORPORATION PRODUCTS

MYCALEX K

A series of ceramic capacitor dielectrics, with dielectric constant selectable from 8 to 19. Low power factor, high dielectric strength. Meets Army and Navy requirements as Class H material (JAN-I-12). To specifications.

MOLDED MYCALEX

Low loss, high temperature injection molded insulation. Molded in union with metals in irregular shapes. High production rates result in economical prices.

MYCALEX K and MOLDED MYCALEX will also withstand 400° C.

MYCALEX CORPORATION OF AMERICA

"Owners of 'MYCALEX' Patents"

Plant and General Offices, CLIFTON, N. J.

Executive Offices, 30 ROCKEFELLER PLAZA, NEW YORK 20, N. Y.

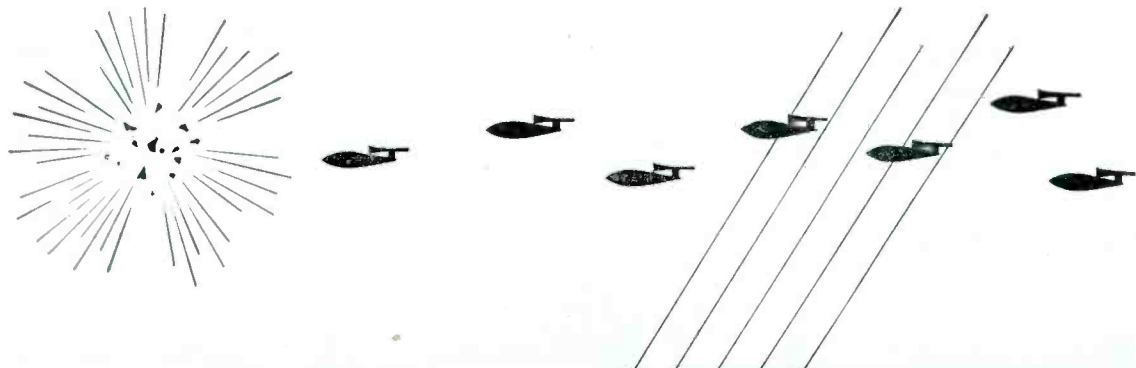

Target practice with Relays and Keys

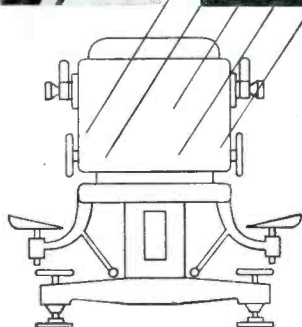
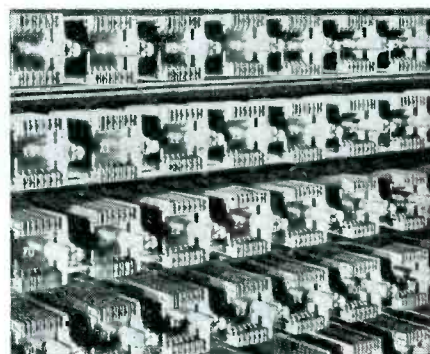

(Left to right) The operator punches the problem data on tape, which is fed into the computer. The solution emerges in the teletype receiver. Relays which figure out the problem look like your dial telephone system.

In designing the gun-control systems which shot down enemy planes, Army ballistic experts were faced by long hours of mathematical calculations.

So Bell Laboratories developed an electrical relay computer. It solved complicated problems more accurately and swiftly than 40 calculators working in shifts around the clock.

Resembling your dial telephone system, which seeks out and calls a telephone number, this brain-like machine selects and energizes electric circuits to

correspond with the numbers fed in. Then it juggles the circuits through scores of combinations corresponding to the successive stages of long calculations. It will even solve triangles and consult mathematical tables. The operator hands it a series of problems with the tips of her fingers — next morning the correct answers are neatly typed. Ballistic experts used this calculator to compute the performance of experimental gun directors and thus to evaluate new designs.

In battle action, Electrical Gun Directors are, of course, instantaneous. Such a director helped to make the port of Antwerp available to our advancing troops by directing the guns which shot down more than 90% of the thousands of buzz bombs.

Every day, your Bell System telephone calls are speeded by calculators which use electric currents to do sums. Even now, lessons learned from the relay computer are being applied to the extension of dialing over toll lines.



BELL TELEPHONE LABORATORIES

EXPLORING AND INVENTING, DEVISING AND PERFECTING FOR CONTINUED IMPROVEMENTS AND ECONOMIES IN TELEPHONE SERVICE

Only CORNELL-DUBILIER could make this CAPACITOR



When a real capacitor problem arises, engineers turn to Cornell-Dubilier *first*.

For example: A recent large installation was planned involving thousands of KVA. Capacitors were required to operate continuously under unusual conditions with a maximum rise of 20° C.

C-D engineers went to work. They made a more compact capacitor capable of meeting all specifications and at the same time cut costs in half.

The new units have been giving satisfactory service ever since their installation and more have been ordered by the same customer.

It is this special ability to tackle tough assignments and to come through with cost-cutting, "long-

life" solutions that you obtain when you call on Cornell-Dubilier.

We are constantly developing new, exclusive designs like this giant mica tank capacitor—watch for others! For cooperation on your capacitor applications or special designs, write Cornell-Dubilier Electric Corporation, South Plainfield, N. J. Other plants at New Bedford, Brookline, Worcester, Mass. and Providence, R. I.

**CORNELL - DUBILIER
CAPACITORS**

MICA • DYKANOL • PAPER • ELECTROLYTICS



New and improved design of oil filled industrial oscillator mica capacitor. Types 97A and 97B can handle a high KVA in one compact unit

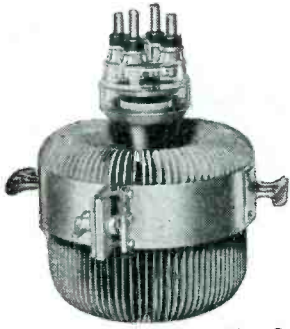

WL-889R



WL-889



WL-473

OSCILLATING

**WESTINGHOUSE
ELECTRONIC TUBES FOR
ELECTRONIC HEATING**

Westinghouse manufactures a complete line of electronic tubes that will meet your RF heating requirements. For descriptive data on any of the types shown,

call your local Westinghouse district office or write:
Electronic Tube Sales Department,
Westinghouse Electric Corporation,
Bloomfield, New Jersey



WL-892



WL-892R



WL-677



WL-678

CONTROLLING



WL-857B



WL-575A



WL-872A/872

RECTIFYING

TUNE IN: John Charles Thomas
—Sunday, 2:30 P.M., EST—NBC
Ted Malone—Mon. through Fri.,
11:45 A.M., EST—ABC

Westinghouse
Electronic Tubes at Work

CONTROLLED ATOMS or CONTROLLED LIVES

SINCE August 6th when the first atomic bomb was released over Hiroshima, the American people have been subjected to a continuous barrage of pronouncements on the use and control of atomic energy. Some of this comment has been strident, and much of it conflicting. A considerable portion of it has been of sincere and constructive excellence.

It has not been easy to separate the wise counsel from the merely noisy, and it is small wonder that the minds of many are troubled and confused.

However, the sheer mass of discussion poured into press and microphone has awakened us all to the gravity of the issue. In terms of any problem on which Americans ever have been called to exercise a judgment—This is It!

Even the dullest now recognizes that atomic weapons hang over modern civilization like the Sword of Damocles, and understands in some measure how fragile and taut is the hair of political balance that holds it suspended.

From this point on, we need the coolest and most carefully considered judgment that can be brought to bear. Discussion highly charged with emotionalism will but increase the tensions both at home and abroad, and render wholly insoluble a delicately intricate problem.

What Is The Problem?

The major outlines of that problem now are coming into focus in understandable terms:

1. The scientists have opened up a new and virtually unlimited storehouse of energy, and the engineers have discovered how to turn it into a military explosive incomparably more powerful than any we have known. We know that this energy may also be used to produce heat for useful power, and we suspect that the radioactive substances produced by the process in hitherto unimagined quantity may also have medical, industrial, and other constructive applications.

2. Terrifying as have been the demonstrations of the atomic bomb thus far, we know that they are as nothing in comparison with its potential destructiveness. The explosive force of individual bombs can be increased tremendously, and means for their effective delivery to predetermined targets in wholesale quantity already are at hand. The experts tell us that no practicable means of interception can be devised, and that reprisal in kind probably will be the only answer to an enemy attack with atomic weapons.

3. So far as we can see now, even successful retaliation would be at best an answer of hollow effect. Any two nations each having wholesale stock-piles of bombs could accomplish the practical destruction of each other.

Since a first treacherous blow might well constitute an enormous advantage, a nation actuated by a ruthless urge to conquest or revenge might have the best chance of survival. But since the widest possible dispersal of bombs and launching units would be dictated by the strategy of atomic weapons, it is doubtful that one nation could destroy another without itself suffering destruction. On both sides the major centers of population could be wiped out, and the nation of least concentrated industrialization and commerce would suffer least. However, no one can be sure that the concentrated explosion of as many as 20 thousand atomic bombs would not poison the atmosphere of the world to an extent that would be fatal to great masses of population, not only within the country bombarded, but perhaps in the country which launched them.

4. The problem is further complicated because, so far as we know now, any large-scale commercial use of atomic energy as a power source is more or less inextricably linked to a potential military use. It is true that, if atomic power becomes economically feasible (which is by no means certain for a long time to come), it would require only low-grade concentrates of fissionable material, which would need further elaborate and costly processing before reaching explosive potential. But the process of producing such low-grade concentrates constitutes perhaps two-thirds of the industrial effort required to make effective bombs. It follows, then, that if nations were to equip themselves to produce large quantities of low-grade concentrates for power generation, the effort required to develop large-scale bomb production would be materially reduced. Moreover, the maintenance of an effective inspection to police agreements not to produce bombs might be forbiddingly difficult if atomic power generation were allowed.

5. In addition to the major problem posed by the use of atomic bombs in international war, any nation which produces or possesses such bombs, or the fissionable materials with which they are loaded, faces still another in the danger of their falling under the control of paranoid elements in its own population.

What Are We Going To Do About It?

We face the hard fact that we have produced a weapon capable of destroying whole nations—perhaps even the whole world. Although we were importantly aided in its development by the nationals of other countries, we, together with Great Britain and Canada, now must take the initiative in deciding what shall be done with it. We have only two choices. We can try to keep this weapon as a monopoly of our own, or we can try to place it under broad international control.

Can We Keep It To Ourselves?

If we know one certain fact about the atomic bomb, it is that it cannot long be held as a monopoly of those nations which produced it.

If Nazi Germany had succeeded in developing the weapon first, it probably would have attempted to achieve world dominion, with utter destruction as an alternative. Such a course is not within our range of choice. It violates every principle for which we stand.

Much reckless nonsense has been uttered concerning the inability of other nations to master the scientific, engineering, and industrial problems involved. It is the virtually unanimous opinion of those who worked on the project that several nations today are fully equipped in science, engineering, and industrial organization to produce atomic bombs and to provide the means for launching them. At least one of these nations, Russia, has also access to an ample supply of the necessary raw materials. The only debate is over whether it would take three, or five, or ten years for her to marshal her resources to produce bombs in multiple thousands. Once such an atomic race were on, we have no reason to believe that Russia might not divert more resources to the task than we ourselves should be willing to put into it.

Additional nonsense is talked as to how we might attempt to cope with the problem of living in a world in which mutually suspicious or hostile nations faced each other, with stores of atomic weapons on both sides. We hear talk of dispersing our cities and even of moving underground. No one has seriously reckoned the difficulty or the cost of following such counsel of despair. Still less has anyone appraised the neurotic effect upon men's minds of living by any such preposterous formula, under continuously mounting tension day after day, and year after year.

Certainly, if we could find no way to prevent the competitive production of atomic weapons, we should be driven at least to the selective dispersion of our bomb-launching facilities, of certain key industrial establishments, and of our centers of government and governing personnel. We should be forced, also, to change our traditional requirement that only Congress can commit us to active war. We should be forced to organize ourselves as a police or military state, with our scientists regimented and muzzled, with all of us under constant surveillance against the smuggling and planting of time-bombs, and constantly alerted against attack through the air.

Before we commit ourselves to any such intolerable procedure, we should be mad not to explore all possible means for making it unnecessary.

The Only Feasible Alternative Is Effective International Control

This cardinal principle has been recognized in the statement of November 15th, issued jointly by President Truman, and Prime Ministers Attlee and King. Their statement frankly concedes that against atomic weapons there can be no adequate military defense, that no nation can command a monopoly of such weapons, that responsibility for eliminating atomic energy as an instrument of war and for devising safeguards over its use for the

advancement of science and other peaceful and humanitarian ends rests upon the civilized nations of the world.

They propose that a commission be set up at once under the United Nations Organization to make recommendations: (a) for extending between all nations the exchange of basic scientific information for peaceful ends, (b) for control of atomic energy to the extent necessary to ensure its use only for peaceful purposes, (c) for the elimination from national armaments of atomic weapons and of all other major weapons adaptable to mass destruction, and (d) for effective safeguards by way of inspection and other means to protect complying states against the hazards of violations and evasions.

Already criticism is leveled at the wording of the statement, at alleged omissions, at the wisdom of choosing the United Nations Organization as the medium through which to seek agreement in view of the weaknesses of the UNO Charter.

None of these issues should be crucially important. What matters is that an invitation has been issued in good faith for the nations of the world to meet and decide upon means for assuring the elimination of weapons, the existence of which no one can afford to tolerate.

The decision cannot be other than international; it will require the best thought of the best brains the world can muster. The smaller nations have an equal stake with the large, and from them may well come the most fruitful suggestions. But Russia now holds the key to the success or failure of our proposal. If she accepts our invitation, no other nation will refuse.

Alternatively, there will be an international armament race paced by atomic weapons. It will mean an end of free science, a severe policing and regimentation of international travel and trade, and innumerable restrictions upon those individual freedoms which we have just fought so desperately to preserve. This is the dismal prospect if we fail to arrive at a genuinely international accord on the control of atomic energy. But even this interval would promise to last only for an uneasy period, until someone started pressing the push-buttons on the panel-boards of extinction.

The only permanent solution lies in finding means to eliminate war itself. That we cannot hope to achieve overnight, but we can, and do hope that the nations will now agree to eliminate atomic weapons and their radioactive by-products as instruments of war.

If they do that, we can move forward more surely to the constructive development of the incalculably valuable resources that science has newly opened to our use. And, we can hope also for a progressive improvement in international understanding.

Unless the nations can reach agreement on this paramount issue of atomic energy, it is difficult to conceive of any vital issue on which they might agree.



President, McGraw-Hill Publishing Co., Inc.

NEW EIMAC EXTERNAL ANODE TRIODE 3X2500A3

Rugged mechanical construction
Outstanding electrical efficiency

In the new 3X2500A3, Eimac engineers have developed a highly efficient external anode triode which, in Class C service, delivers up to 5 KW output at a plate voltage of only 3,500 volts. The mechanical design is radically simple, incorporating a "clean construction" which gives short, low inductance heavy current connections that become an integral part of the external circuits at the higher frequencies.

The external anode, conservatively rated at 2500 watts dissipation, has enclosed fins so as to facilitate the required forced air cooling.

Non-emitting vertical bar grid does not cause anode shadows ordinarily created by heavy supports in the grid structure.

Thoriated tungsten filament. Note unusually large filament area, and close spacing.

Filament alignment is maintained throughout life of the tube by special Eimac tensioning method.

New glass-to-metal seals do not have the RF resistance common to iron alloy seals, nor the mechanical weaknesses of the feather-edged types.

Grid ring terminal mounts a cone grid support which acts as a shield between plate and filament.

A coaxial filament stem structure forms the base of the tube. This makes possible proper connections to the filament lines.

Grid and filament terminal arrangements make it possible to install or remove the 3X2500A3 without the aid of tools.

The new mechanical and electrical features of the Eimac 3X2500A3 external anode triode make it valuable for use on the VHF as well as low frequencies. More complete data and information yours for the asking.

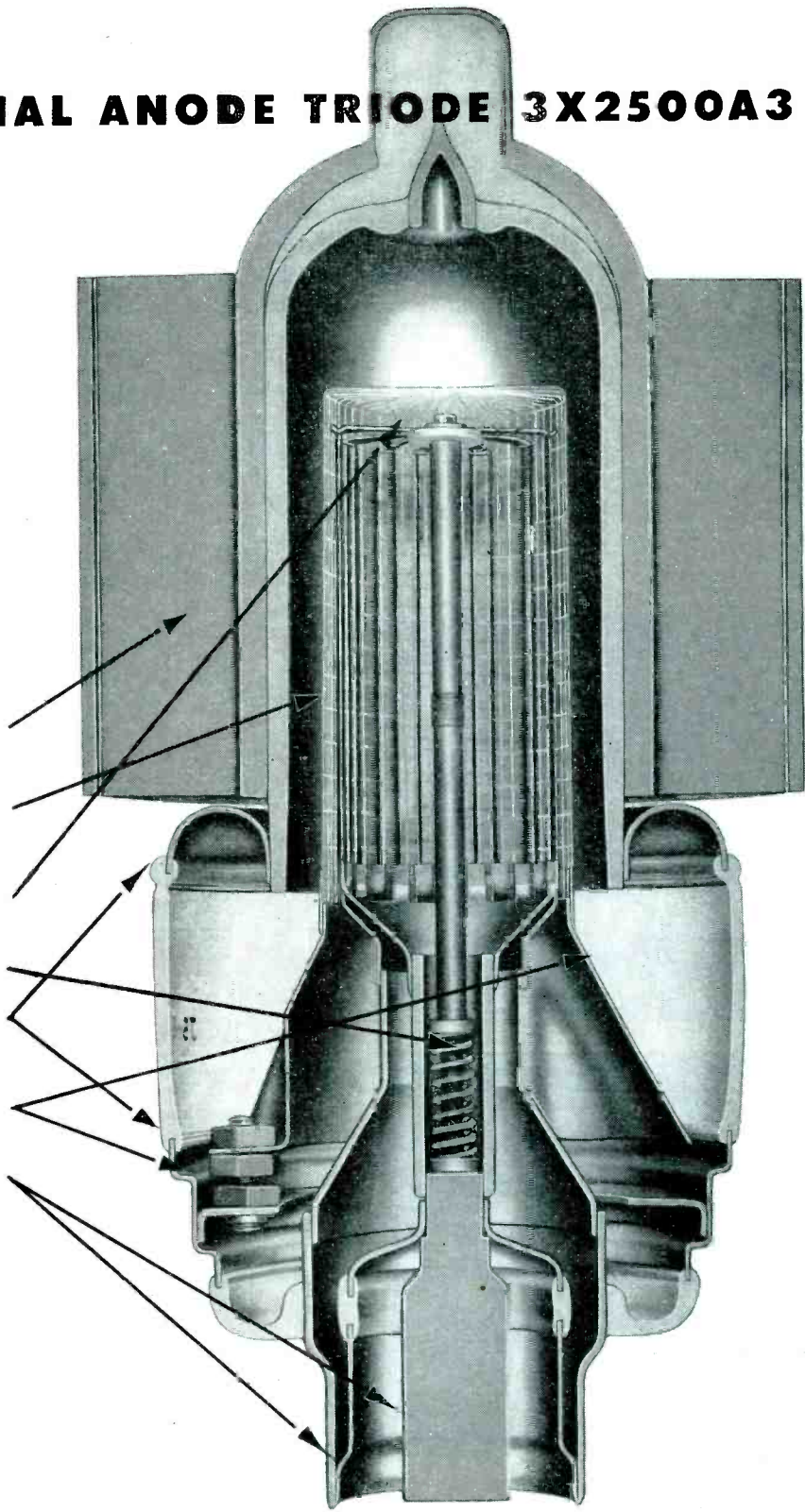

FOLLOW THE LEADERS TO



EITEL-McCULLOUGH, INC., 1123 San Mateo Ave., San Bruno, Calif.

Plants located at: San Bruno, Calif.  and Salt Lake City, Utah

Export Agents: Frazer and Hansen, 301 Clay St., San Francisco 11, Calif., U.S.A.

TYPE 3X2500A3 — MEDIUM MU TRIODE

ELECTRICAL CHARACTERISTICS

Filament: Thoriated Tungsten	
Voltage	7.5 volts
Current	48 amperes
Amplification Factor (Average) 20	
Direct Interelectrode Capacitances (Average)	
Grid Plate	20 <i>u</i> fd.
Grid Filament	48 <i>u</i> fd.
Plate Filament	1.2 <i>u</i> fd.
Transconductance ($i_b=830$ ma., $E_b=3000$ v.) 20,000 μ ms	

Pre-Testing of MALLORY SWITCHES Assures Precision Performance

MALLORY has pioneered in developing new designs for both rotary and push-button switches, and in manufacturing them from improved materials. To make sure of the electrical performance and long life of these switches, Mallory puts them through punishing tests.

The complete line of Mallory *standard, pre-tested* precision switches and other electronic components is available from your nearest Mallory Distributor. See him today, and ask for your free copy of the Mallory catalog—containing specifications for switches, jacks, plugs, capacitors, resistors, rectifiers and other parts. Or write us today.

P. R. MALLORY & CO., Inc., INDIANAPOLIS 6, INDIANA

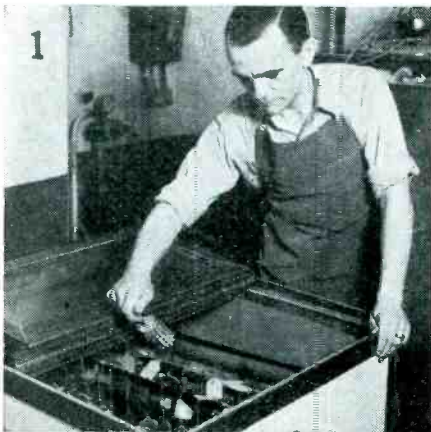

1 SALT SPRAY TEST: In a few short hours, switches are subjected in this salt spray chamber to conditions that equal years of marine service.

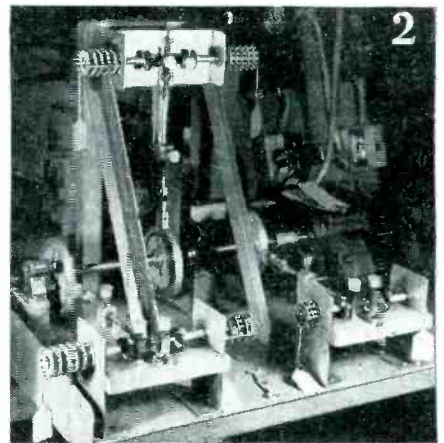

2 SWITCH LIFE TEST: Hour after hour, this machine continues to operate the switch until it is destroyed. Results enable Mallory to develop switches with operating life exceeding normal requirements.

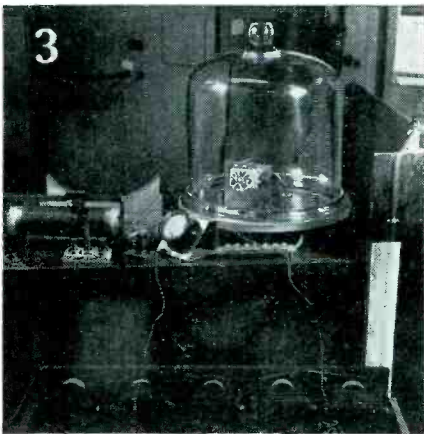

3 LOW ATMOSPHERIC PRESSURE TEST: The rarified air of the stratosphere is reproduced inside this large bell jar. Data from this test has aided Mallory in developing better switch construction for aircraft application.



4 FUNGUS CONTROL: In this laboratory, fungus cultures from the tropics are used in testing the fungicidal properties of new impregnating materials for the insulation in Mallory Switches.



P. R. MALLORY & CO. Inc.

MALLORY



Industrial and Electronic Switches



CROSS TALK

► **HEAT** . . . Electronic heating gets up into the high power regions where a potential user of the equipment naturally wants to know how much juice he must put in and pay for. His curiosity concerning how much he is going to get out is also natural.

In the case of motor-generator equipment, the horsepower rating of the driving motor and the kw output of a high-frequency generator are established by well-recognized and standardized testing procedure. In the case of the spark-gap or vacuum-tube oscillator, however, the kw output available for heating is not as readily measurable by the usual electrical means.

This may account for some of the efficiency figures we see quoted by manufacturers of spark-gap and tube heating equipment; certainly the situation calls for some quick standardization by the several bodies interested in such matters.

Speaking of tube-type machines, the plate efficiency of an oscillator will seldom exceed 65 percent and when one takes into account the tank losses, transformer losses, filament losses and other wastages of power, the overall ratio between output and input cannot be greater than one-half and is quite likely to be below.

Standard methods of measuring electronic heating efficiency and of rating this important quantity are urgently needed.

► **BOMB** . . . One of our imaginative broadcast stations phoned the atomic bomb people a day or so after the New Mexico trial explosion to request the Army to shoot off another bomb so that a sound-effects record could be made.

And incidentally, there were only two violations of security regarding the Kellogg Corporation, one before VJ day by a broadcast station and one after the war's end by a national magazine of news comment.

► **MORE TALK** . . . Most present criticism of broadcast programs is on two points, advertising blurbs, and serials. Now this is just a hunch, but maybe this criticism is really against the great amount of talk on the air. Maybe people really want more music. Any casual turning on of the radio at practically any station at any time of the day will produce talk. If the listener wants music he must know when to get it, and, of course, even when he gets his music he must put up with a great deal of talk.

CBS has made a study of the serial situation to find out who listens to them, who likes them, and how much. Taking a typical Wednesday in Dubuque, CBS charted the situation from eight in the morning to six in the evening. In this day there were 40 quarter-hour periods and on this particular day listeners in Dubuque could tune to an average of about eight or nine stations at any particular moment. There were actually 347 individual programs during that time, 93 of them being music.

The listener who merely snapped on the radio had only a 27 percent chance of finding music and casually turning on the radio would result in a 73 percent chance of getting into the midst of a talk program. Considering that there was an average of 8 or 9 stations operating at any one time, the listener who wanted music would have to do a lot of hunting. After he had pushed several buttons or had dialed to several stations and found talk, he would probably turn the radio off and forget about it.

So far as serials are concerned, there were 51, and if you were serious you could listen to serials solid from nine to five except for a 15-minute period after lunch. During the rest of the time there were one, two or even three going on at once.

P.S. CBS's survey indicates that people like serials.

Fire-Control

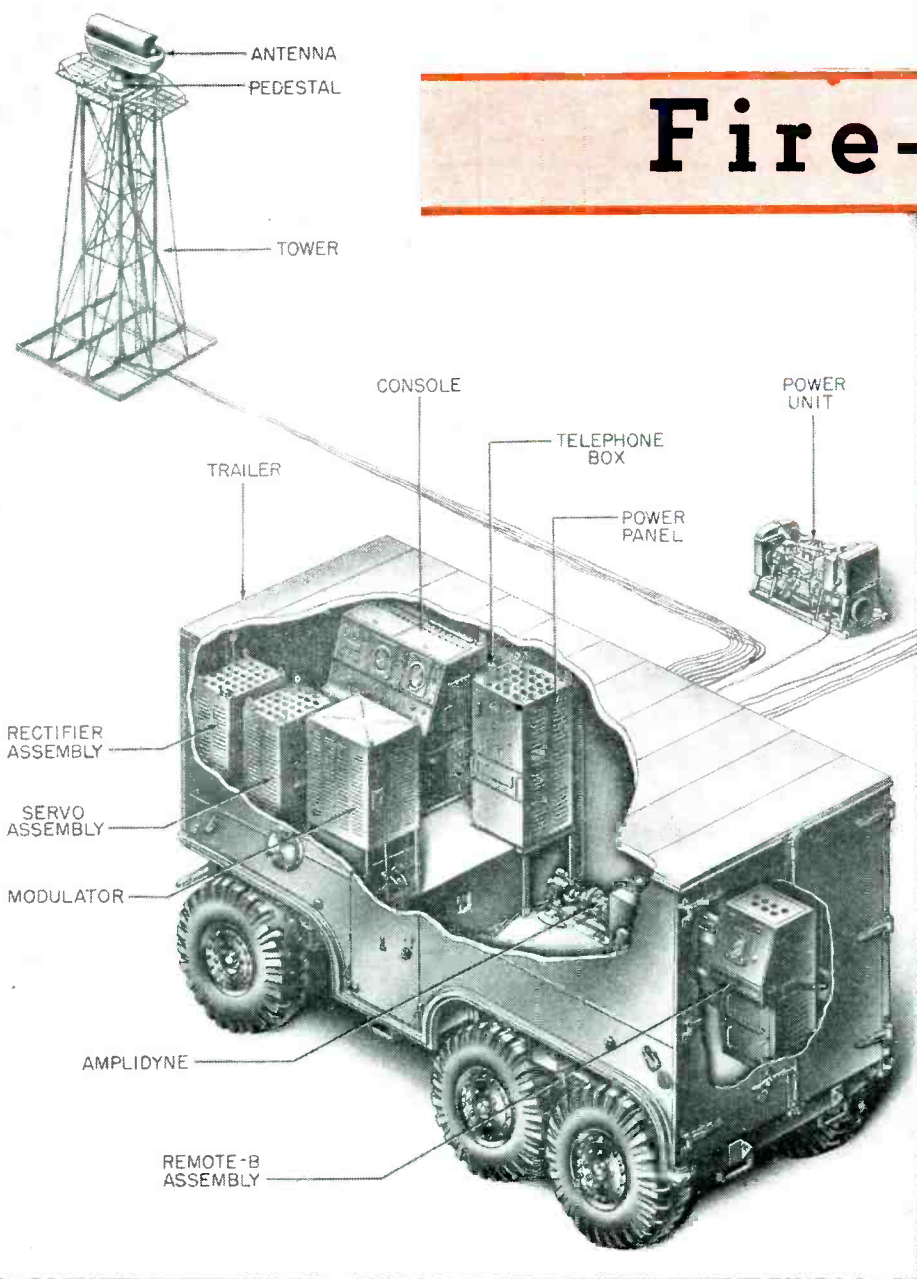

FIG. 1—The 3-cm fire-control radar AN/MPG-1, showing the trailer, power unit and antenna in operating position. The setup is adjacent to a gun battery, usually near a harbor or along a coastline

type set was assembled in mobile form and de-bugged by the 15th of November, 1943. After five days operation at a station in Boston harbor, the set was transported to a Coast Artillery test site at Fort Story, Virginia.

A few months before completion of the prototype model, the Marine Corps became interested in the set for use with their seacoast artillery. This led to a revised unit, called the AN/MPG-1, which is housed in a trailer van made water-tight up to the roof.

General Design

When in use, the AN/MPG-1 is set up as shown in Fig. 1, overlooking the harbor or coastline it is meant to defend. Capable of being placed in operating condition a few hours after selection of a site, the radar can begin its tactical functions by the time the gun battery is installed. Present-position data on any designated target are transmitted to the battery command post where the information is fed directly into a computer which supplies firing data to guns, or is used to furnish data for a plotting-board course of the target from which its future position is predicted.

The technical characteristics of the AN/MPG-1 are given in Table I.

Because of the narrow beam-width, dipole (window) jamming of the set is not readily accomplished. The resolution is such that at 20,000 yards two destroyers separated by 300 yards of open water are seen as separate targets on the tracking scope. This high resolution enables skilled operators to track targets readily through heavy concentrations of ships, buoys, islands and floating wreckage, with minimum danger of tracking the wrong target.

The high accuracy of major-caliber seacoast weapons dictated certain features of design. High resolution and extreme accuracy

THE ALLIES faced a serious military situation in the spring of 1942. Attacks on important American harbors by PT boats were considered possible. At that time, no radar existed which could adequately detect and track these small, fast, maneuverable craft. So the Coast Artillery Board on the 20th of May set up characteristics for a radar which could supply position data on PT boats to a data computer for seacoast gun batteries.

Meanwhile, the National Defense Research Committee, with funds supplied by the Office of Scientific Research and Development, had be-

gun to study the problem of supplying fire-control data to major-caliber guns at the Radiation Laboratory at M.I.T. When, therefore, in August 1942, the Signal Corps submitted the anti-motor-torpedo-boat project to NDRC for development, progress already had been made.

The Radiation Laboratory proto-

**electronics
WAR REPORT**

Radar MPG-1

First description of microwave radar operating on 3 cm with sufficient speed and accuracy to enable coast artillery to hit maneuvering PT boats. Control of harbor traffic in peacetime is suggested by the design. Further details will follow in subsequent articles

By **H. A. STRAUS, L. J. RUEGER, C. A. WERT**

Radiation Laboratory, Massachusetts Institute of Technology, Cambridge, Mass.

and **S. J. REISMAN, M. TAYLOR, R. J. DAVIS, J. H. TAYLOR**

Radio Division, Bendix Aviation Corp., Towson, Md.

were required in both range and azimuth. Resolution requirements dictated small angular divergence of the beam. The antenna system in the horizontal direction had to be large in terms of wavelengths. However, angular position had to be controlled very accurately. Since the moment of inertia of similar bodies increases as the fifth power of the size, it was not practical to increase too much the size of the antenna assembly carried on the azimuth drive system. Very severe problems were presented by the requirements of the servo system which controls antenna position. Tracking had to be smooth and accurate to within 0.01 deg at tracking speeds of less than 0.01 deg to more than 1 deg per second.

It was decided to employ an electrical method of antenna scan rather than to try to oscillate a large mass physically. The scan

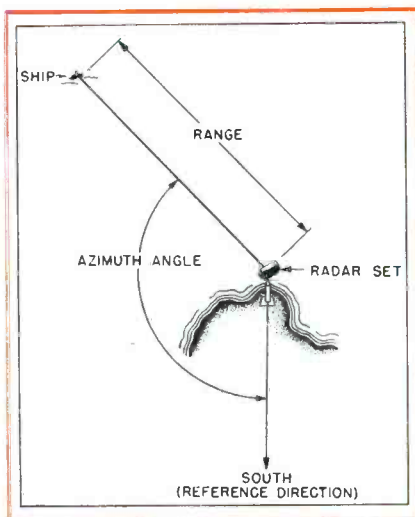

FIG. 2—Definition of range and azimuth

had to be frequency-insensitive to assure accurate pointing of the beam, regardless of variations in characteristics of different transmitter tubes. A stigmatic optical system without spherical aberration

had to be built having wide field, high speed, compactness and freedom from coma. It was necessary also to develop a modulator capable of being very accurately triggered and delivering a 0.25-microsecond pulse to the magnetron, with accurate control of the pulse rise and decay time. To achieve maximum range resolution permitted by the pulse length, a broadband i-f strip (approximately 10 mc bandwidth) and video circuits had to be developed for the receiver.

Some of the men responsible for the development and production of the AN/MPG-1 are listed in a footnote *.

Design Details

Essentially, the direction, or azimuth, of a target is specified by the direction of the beam when it illuminates the target. Azimuth

FIG. 3—PPI view of Pearl Harbor, 80,000-yard sweep with 10,000-yard electronic range markers

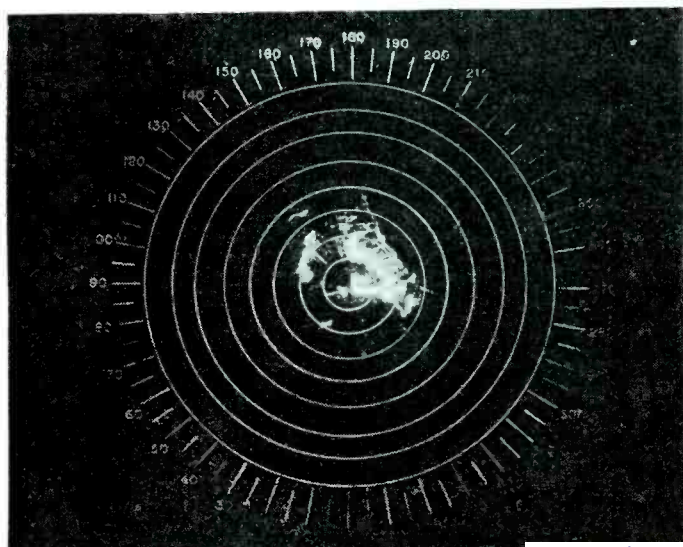
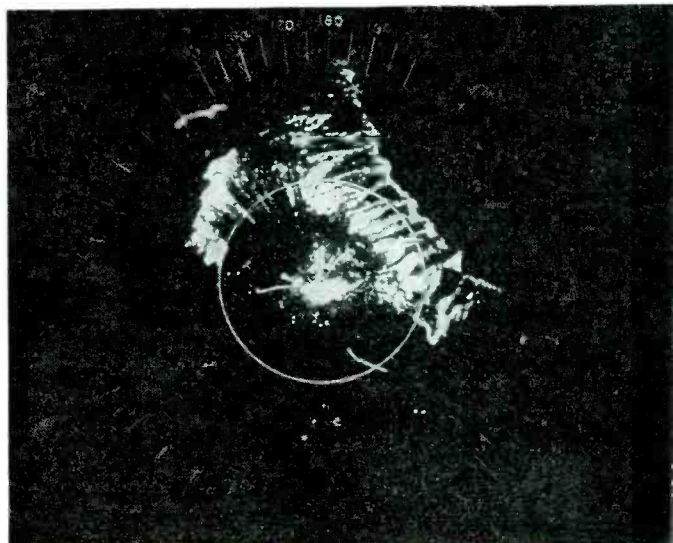

FIG. 4—PPI view of Pearl Harbor, 30,000-yard sweep with movable electronic range marker



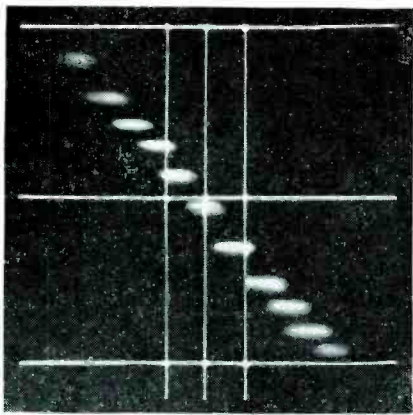

FIG. 5—B-scope presentation of eleven LCI's shown intercepted by the range marker in Fig. 4 at 12,900 yards and 329 degrees. Resolution makes it possible to distinguish ships separated by less than 300 yards of open water

and range are defined in Fig. 2.

Pulse transit time is measured by means of cathode-ray oscilloscopes. The oscilloscope range sweep is synchronized with a pulsed transmitter. At the moment an r-f pulse leaves the antenna, a linear deflecting voltage is applied to the oscilloscope electron beam. At the end of the desired time interval, the deflecting voltage suddenly falls to zero, allowing the electron beam to fly back to its original position where it remains until the transmitter is pulsed again, whereupon the cycle is repeated. Since the sweep trace is generated at a constant, known speed, any segment of this trace is a linear measure of time. After a pulse has been emitted and the sweep has begun, an echo may be received by the antenna. The echo signal is demodulated, amplified and applied to the indicator.

Surveillance

Surveillance data are viewed on a 7-inch conventional plan-position-

* I. A. Getting, H. A. Straus, C. W. Miller, W. P. Manger, R. H. Caston, R. W. Illman, E. A. Holmes, A. E. Whitford, W. B. Coon, C. A. Wert, L. J. Rueger, E. Whitham, L. J. Chu, C. V. Robinson, H. Logemann, G. Hite, C. W. Sherwin, J. R. Niles, L. D. Smullin, R. V. Pound, F. T. Woirell, and D. B. Nicholson, all of the Radiation Laboratory, M.I.T.; M. Taylor, J. H. Taylor, P. De La Cova, R. J. Davis, A. R. Keskinen, J. B. Sherr, J. T. McNaney, S. J. Reisman, and A. E. Abel of the Bendix Radio Division; Lt. Col. J. J. Slattery, Capt. Vollum, Lt. D. M. Kerns, Lt. C. G. McMullen, W. B. Gould, W. B. Allison, R. A. Fletcher, F. W. Fisher and F. J. Kitty of the Signal Corps; Col. W. S. Bowen, Lt. Col. A. W. Clement, Maj. J. M. DuPare, and Sgt. L. A. White of the CAB; Lt. Col. M. B. Lampl, Army Ground Forces; Lt. Col. J. L. Dickey, USMC. This work was done under Contract Number OEMsr-262 under the auspices of the Office of Scientific Research and Development, which assumes no responsibility for the accuracy of the statements contained herein.

indicator (PPI) on which two alternative maximum ranges, 80,000 and 30,000 yards, may be selected by the operator with the results shown in Fig. 3 and 4.

The PPI presentation is a polar map extending to the edge of the oscilloscope screen and displaying signals from all unshadowed reflecting objects at any horizontal distance from the antenna up to the maximum range of the set. The center of the map corresponds to the antenna location. Starting from the center of the screen in synchronism with the emitted pulse, the range sweep proceeds to the edge of the screen in the same relative direction as that taken by the pulse in free space. Rotation of the sweep is effected by means of a servo which causes the PPI deflection yoke to follow the movement of the antenna. To facilitate the taking of azimuth readings, a rotatable scale with an engraved line is provided over the scope face. When the engraved line is placed over a signal, the target azimuth is indicated on the scale. Target range is determined by the distance of the target signal from the center of the scope.

Eight fixed 10,000-yard electronic markers are provided on the 80,000-yard range. On the 30,000-yard range, instead of fixed markers a single electronic, movable range-marker is provided. This makes closer range estimates possible, for if the movable marker

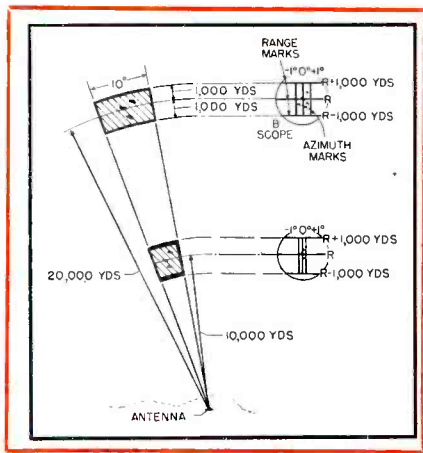

FIG. 6—A nearly distortionless map of the target area is obtained by means of azimuth expansion. Modified type-B presentation causes targets of like size and aspect to appear approximately the same on the oscilloscope screen regardless of their distance from the radar

is cranked out to the target signal, the approximate range will be indicated on a dial. The movable marker may be used in selecting a target to be tracked on the tracking scope. If the movable range

TABLE I

CHARACTERISTIC	GENERAL
FREQUENCY	10,000 mc (3 cm)
POWER OUTPUT	35 kw peak, 35 watts average
BEAM WIDTH ($\frac{1}{2}$ -power points on transmitting beam)	0.6 degrees in hor. plane, 3 degrees in vert. plane
ANTENNA GAIN	12,000
TRANSMITTER	magnetron
RECEIVER	superheterodyne
Sensitivity	55 db below 1 mw
Local Oscillator	klystron
Intermediate Frequency	30 mc
Bandwidth	10 mc ($\frac{1}{2}$ -power points)
Maximum Gain	1,000,000
POWER CONSUMPTION (Complete equipment)	5 kva
	SEARCH TRACKING
PULSE REPETITION FREQ.	1024 cps 4097 cps
PULSE WIDTH	1 μ sec 0.25 μ sec
MINIMUM RANGE	200 yards 50 yards
MAXIMUM RANGE	80,000 or 30,000 yards 28,000 yards
RANGE ERROR	3% of max. range Not over 20 yards
AZIMUTH ERROR	2 degrees 0.05 degrees

marker is brought into coincidence with a target signal and the antenna is positioned so that the target is in the line of sight, the target will appear near the center of the tracking scope when this scope is switched on.

Tracking

An area 2,000 yards in depth by 10 deg in width is represented on the 7-inch tracking scope, as shown in Fig. 5. The center of this area corresponds to the intersection of the antenna line of sight with a circular arc, the radius of which is equal to the range represented by the PPI movable range marker. Type-B presentation is employed (rectangular coordinates) with range as ordinate and azimuth as abscissa. The range sweep starts near the bottom of the screen, the azimuth sweep at the left of center. Range and azimuth electronically-generated fiducial marks intersect in the center of the screen. The tracking operation consists of displacing the target signal until its front edge is centered at the crossed fiducial marks.

As long as the operators maintain the target signal in this position, accurate present-position data may be read from range and azimuth dials and transmitted electrically and by telephone to a gun data computer over a standard base-end transmission system. Range and azimuth-aided tracking machines with slewing and tracking controls are provided to permit smooth and accurate tracking.

Normal or expanded Type-B presentation may be selected by the operators. In the normal display, the range scale factor (in the vertical direction) is constant at 400 yards per inch, and the horizontal linear distance (on the tube face) representing 10 deg in azimuth is held constant regardless of range. With the expanded Type-B presentation, however, the scale factor in the horizontal direction is held constant at 400 yards per inch, resulting in an azimuth presentation which expands in direct proportion to range. As a result of azimuth expansion, signals from targets of the same size and aspect appear to be approximately the same size on the oscilloscope screen regardless of the target distance from the antenna. With this type of presentation, a nearly distortionless map of the target area is obtained as shown in Fig. 6. Since the useful length of the tube face is approximately 5 inches, only 2,000 yards can be shown in the horizontal direction; and for ranges in excess of 12,000 yards, the full 10 deg in azimuth can not be presented.

In addition to the fiducial markers, electronically-generated azimuth markers representing azimuth + 1 deg and azimuth - 1 deg, and range markers representing range + 1,000 yards and range - 1,000 yards, are presented on the tube face. A separate Type-B oscilloscope without expanded display is located at a remote point and is used in spotting fall of shot.

It is impossible to operate simultaneously the PPI and B-scope from synchronizing and video pulses originated by the AN/MPG-1. However, facilities are provided for simultaneously operating the B-scope and the PPI if synchronizing and video pulses and servo

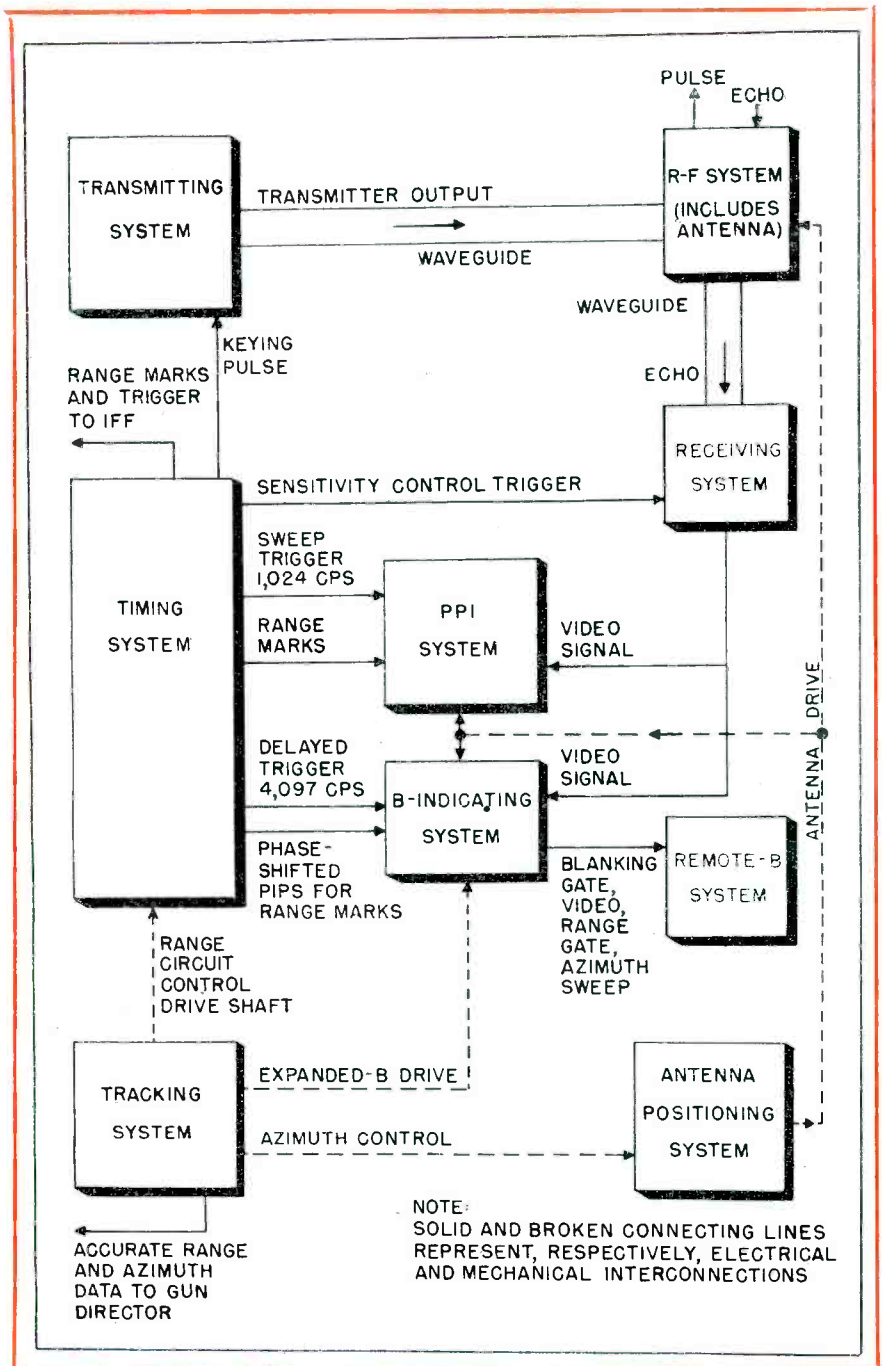

FIG. 7—Block diagram of the complete AN/MPG-1 radar, showing the nine major systems involved. Six of these are further broken down in the succeeding figures

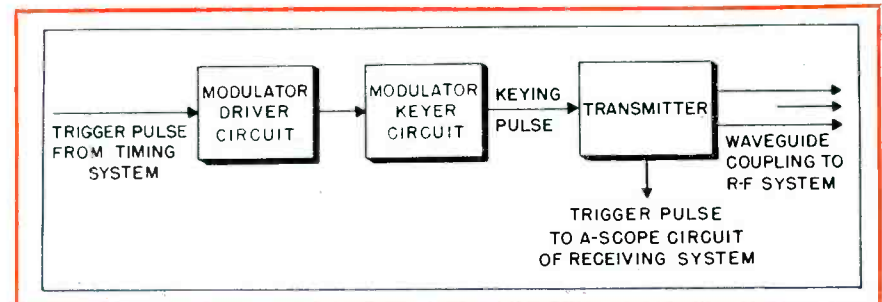

FIG. 8—The transmitting system, shown as a single block in Fig. 7

data are fed to the set from a remotely-located, separate-surveillance set. This makes it possible for the operators to accomplish general sector surveillance on the PPI while tracking specific targets on the B-scope.

Component Systems

For purposes of explanation, the AN/MPG-1 is best divided into nine systems, shown in block diagram form in Fig. 7. Block diagrams of the main groups of circuits within each system follow.

The transmitting system shown

in Fig. 8, triggered by a pulse from the timing system, generates pulses of r-f energy which are radiated into free space by the r-f system. A rectangular voltage pulse (of one microsecond width when the PPI is used and $\frac{1}{4}$ -microsecond width when the B-scope is used) is generated by the modulator driver circuit and applied to the modulator keyer circuit. A keying pulse (amplitude approximately -11 kv) is applied to the magnetron, which oscillates when the keying pulse is on. High-power, accurately timed, rectangular pulses of 3-centimeter energy

are coupled to the r-f system by a waveguide.

The r-f system radiates the r-f pulses and feeds reflected energy to the receiving system. When properly adjusted, a coupling and matching device shown in Fig. 9 matches the transmitter impedance to the output. The duplexer, located in the receiver, contains the TR and anti-TR switch tubes which permit use of the same antenna for transmission and reception. Four waveguide feed arms, through which r-f energy is fed into the antenna, are provided in the rotating feed assembly. When the PPI is used, one of the feed arms remains fixed at the center of the antenna throat, and energy is radiated in the direction of the antenna axis. When the B-scope is used, the feed assembly rotates at a speed of 4 rps, resulting in 16 sweeps per second of the feed arms across the antenna throat. This action causes the emitted beam to sweep 16 times per second across a 10 deg sector centered on the antenna axis. The direction of the antenna axis is variable from zero degrees to 360 deg regardless of the type of presentation used. The antenna assembly forms the r-f energy into a narrow beam which is projected horizontally into space. Received energy is concentrated by the antenna assembly and fed to the receiver through the rotating feed.

The receiving system shown in Fig. 10 detects and amplifies the echo signals. A klystron local oscillator, a signal mixer and an afc mixer comprise a circuit which converts the received signal to an i-f signal of 30 megacycles. If the transmitter frequency drifts, the afc circuit changes the klystron repeller voltage, thus changing the local oscillator frequency by the amount needed to maintain a 30-megacycle i-f. The video output circuit detects and amplifies the i-f signal.

Pulse Timing

The timing system shown in Fig. 11 contains the synchronizing circuits for the entire radar set. Two outputs are obtained from the crystal oscillator and phase-shifter circuit; a 163.88-kc reference sine-

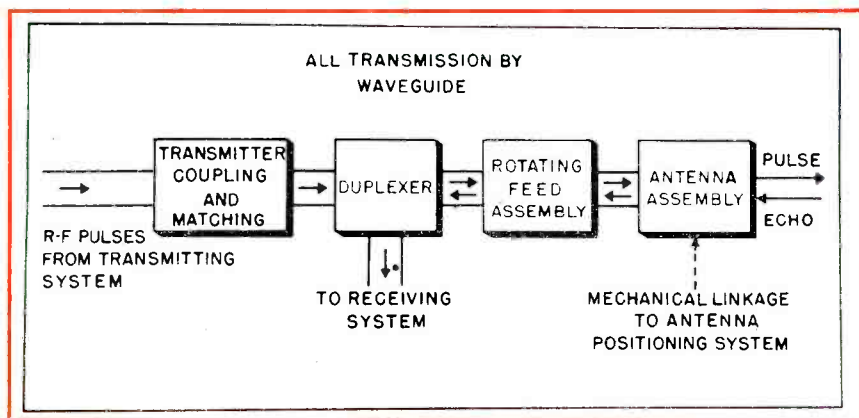

FIG. 9—The r-f system

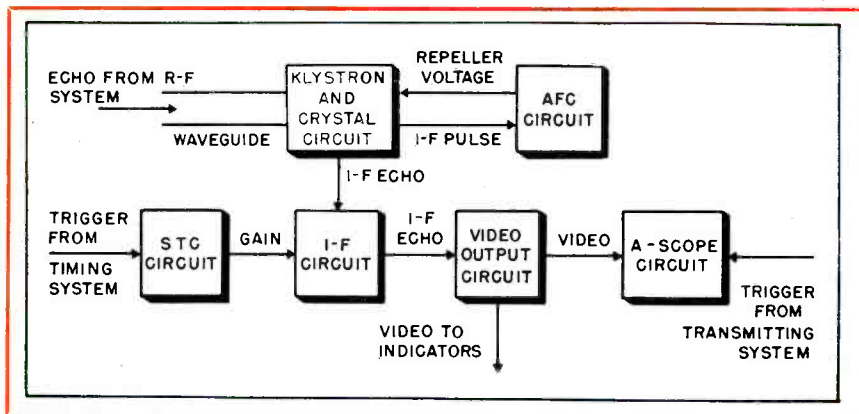

FIG. 10—The AN/MPG-1 receiving system

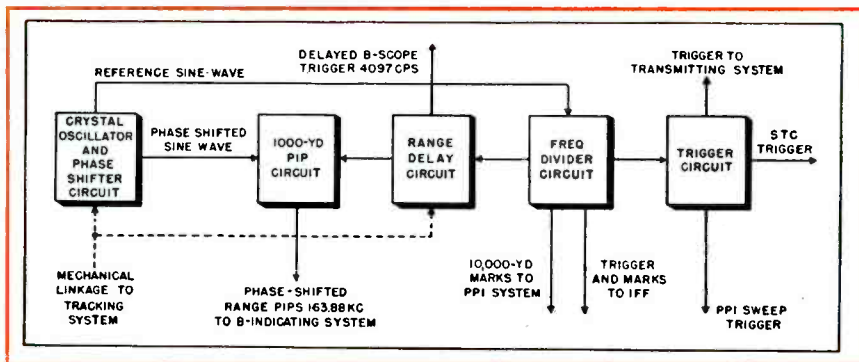

FIG. 11—The timing system

wave and a phase-shifted sinewave of the same frequency. The phase difference between these two sine-waves is proportional to the range tracking dial setting. Pulses recurring at a rate of 163.88-kc are derived from the phase-shifted sinewave and fed to the B - indicating system, where they are formed into 1,000-yard range markers. The time interval between two successive 163.88-kc pulses is equal to the time required by a radar pulse to make a round trip to a target 1,000 yards from the antenna. The 2,000-yard B-scope presentation, covering an area anywhere from zero range to 28,000 yards, is made possible by the range-delay circuit which provides delayed B-scope range-sweep triggers. The delay is proportional to the range-tracking output and is the means whereby the 2,000-yard B-scope area is moved in range. By means of this circuit the position of the movable marker on the 30,000-yard PPI also is made dependent on the range tracking output. Synchronizing triggers required for the radar set are derived from the reference sinewave.

The PPI system shown in Fig. 12 is used for general sector surveillance and selection of targets to be tracked on the B-scope. A synchronizing trigger is applied to the sweep circuits either from the timing system or a separate radar set. Besides generating the sweep voltage, the sweep circuit provides a switching gate for a remote range marker circuit which is operative only when the radar receives PPI data from a separate search set. The remote range marker circuit produces 10,000-yard markers for the 80,000 and 30,000-yard displays. However, the local range marker circuit provides 10,000-yard markers for the long-range PPI and a movable marker for the short-range display. Synchronized with the antenna through the servo circuit, the PPI deflection yoke always takes a position such that the direction of the range sweep indicates the direction of the emitted pulse.

The B-indicating system shown in Fig. 13 provides a rectangular map of a 2,000-yard by 10 deg sector centered anywhere within the tracking range of the set. The

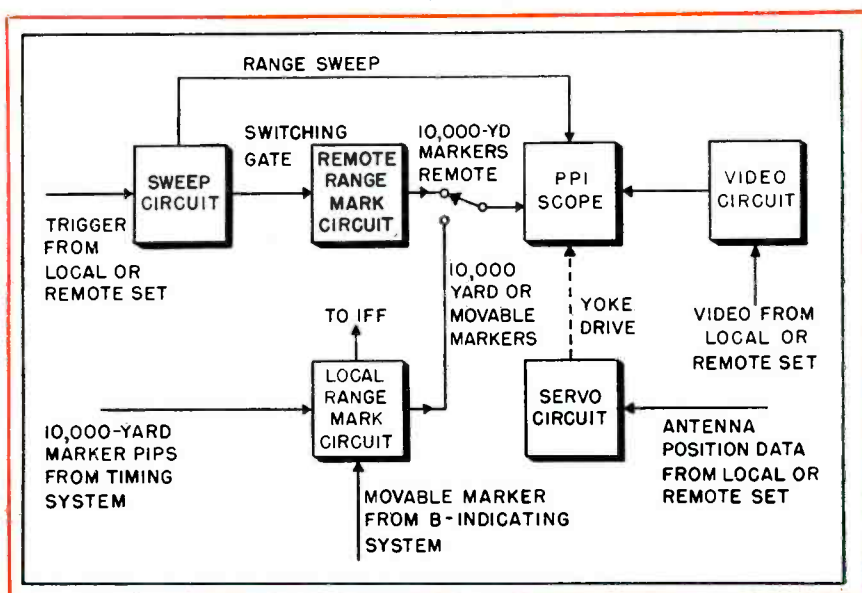

FIG. 12—The PPI system

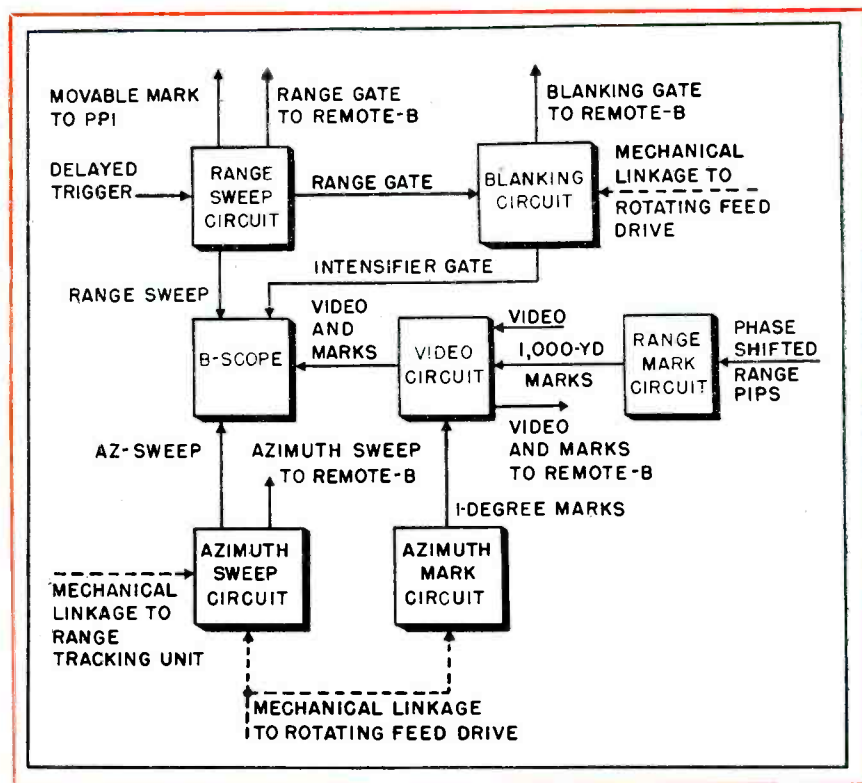

FIG. 13—The B-indicating system

azimuth sweep, markers and blanking gate circuits are mechanically coupled to the rotating feed drive. Received signals intensify the range-sweep traces. During the range-sweep fly-back interval, the B-scope is entirely blanked out. Expanded azimuth presentation is obtained through mechanical linkage to the range tracking unit.

By means of the antenna positioning system, the antenna is made to slew or scan on PPI or to slew or track on B-presentation.

The tracking system provides aided or manual tracking in range and azimuth.

A special spotting mechanism is provided in the remote-B system that allows an operator to read range and azimuth deviations of the center of impact when he places curcours over the shell-splash signals. By this means the center of impact of succeeding rounds is made to fall directly on the target, and the military function of the set is fulfilled.

Generator-Powered

An electronic detonator. Wind-vane drives compact generator and arms projectile after safe interval of flight. Careful design of miniature r-f oscillator, feedback amplifier and thyatron circuits locates burst point at optimum position

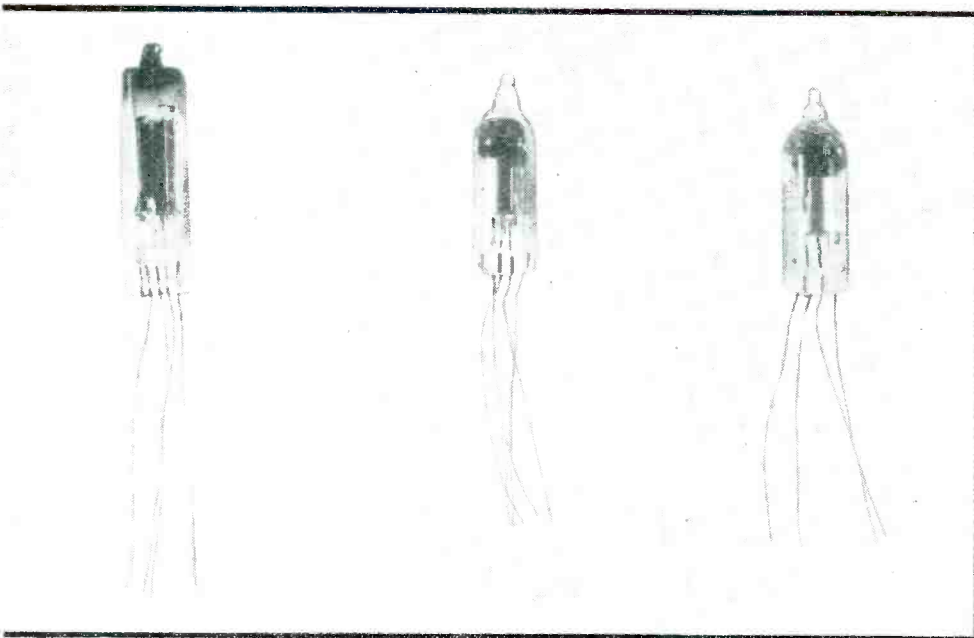

Fuze tubes, shown approximately actual size. At the left is a triode, in the middle a pentode, and on the right a thyatron

THE GENERATOR-POWERED proximity fuze for airborne rockets, developed at the National Bureau of standards under the joint sponsorship of OSRD and Army Ordnance, is another example of the electronic detonating technique described in *ELECTRONICS* for November 1945. With the advent of the proximity fuze the saying "a miss is as good as a mile" is no longer true, because it has now been found that near misses can frequently be ten times as effective as direct hits.

Fuze Characteristics

The fuze to be described contains within it a complete radio transmitter and receiver, amplifier, electronic detonator, wind-driven generator, and safety devices, arranged as shown in the block diagram of Fig. 1. The rocket itself,

together with an insulated ring mounted on the nose, serves as the transmitting and receiving antenna. An equivalent antenna and feed system are indicated.

When the rocket is fired its acceleration releases a safety latch which permits the power vane to rotate in the air stream. The vane turns the generator at about 40,000 rpm to supply filament, plate, and bias voltages. It also drives a gear train which connects the firing circuit after the fuze has traveled a predetermined distance,

termed safe air travel. The fuze can be set for any desired value of safe air travel greater than a certain minimum. This arming method insures that the fuze is always well away from the launching aircraft before it becomes active.

Within a fraction of a second after the rocket has been fired, the fuze circuit warms up and all transients die out. By the time the safe distance has been traversed arming is completed, and the fuze is ready for operation.

Fuze Radiation Reaction

Assume that the fuze transmitter is in operation and that the rocket has come close enough to its target to receive appreciable reflected signal. The rocket sends out a continuous wave, part of which is reflected back to establish a small voltage in the antenna. This voltage is proportional to the antenna current but not necessarily in phase with it. The presence of the reflecting target thus has the effect of changing the antenna impedance by an amount Z such that $Z = e/I$ where I is the antenna current and e is the instantaneous voltage due to the reflected radiation.

As the distance to the target decreases, two things happen: The size of e increases as the reflection becomes stronger and the phase between e and I changes by 180 degrees each time the target distance is reduced by a quarter wavelength.

The simple vector picture of Fig. 2 shows what goes on as the fuze approaches the target. Here Z_0 represents the antenna input impedance (usually resistive as the antenna is tuned to resonance), when there are no reflectors near by. The impedance due to the reflector is

**electronics
WAR REPORT**

Proximity Fuze

By
R. D. HUNTOON
 and **B. J. MILLER**

Ordnance Development Division
 National Bureau of Standards
 Washington, D. C.

represented by Z . As the fuze approaches the target the end of the Z vector traces a spiral shown by the dotted curve. The total antenna impedance thus varies periodically from minimum (point A) to maximum (point B) going through one cycle each time the path shortens by $\lambda/2$. If the velocity of the fuze toward the target along the line joining them is v , then

$$f = \frac{v}{\lambda/2} = \frac{2v}{\lambda} \quad (1)$$

where f is the rotational frequency of Z . This frequency has been called the Doppler frequency be-

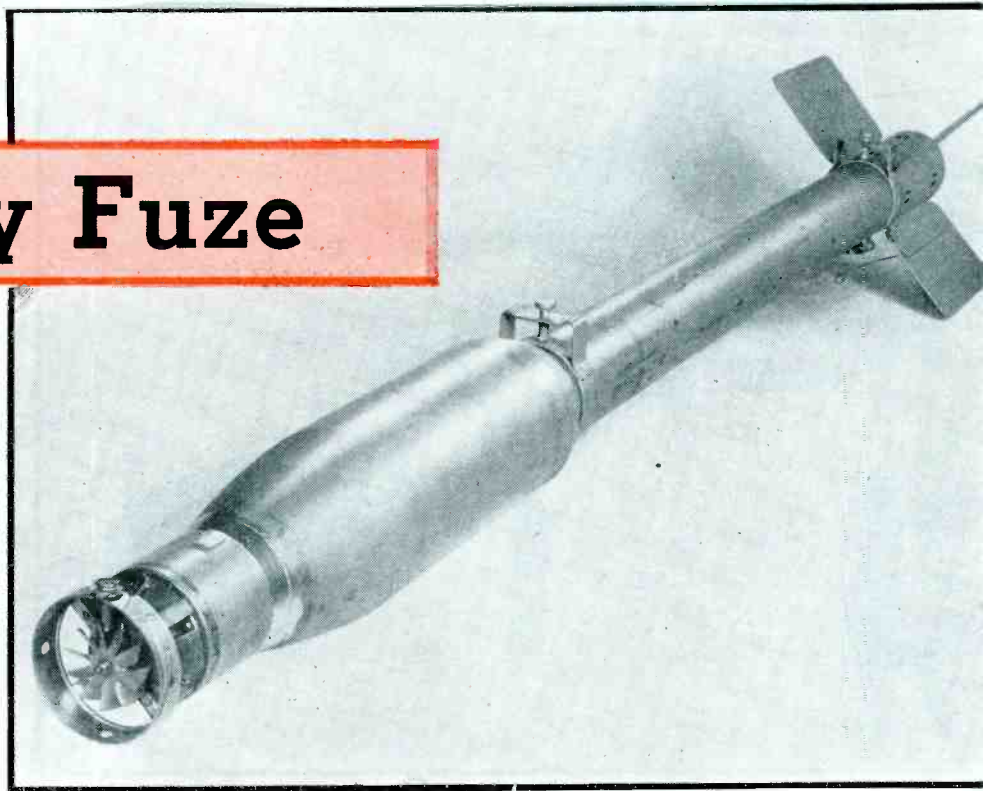

Rocket armed with generator-powered electronic fuze

cause the same result is obtained if the difference between transmitted frequency and received frequency is calculated, taking into account the relative motion of fuze to target.

For small reflections the value of I (antenna current) is little af-

ected by e (voltage due to reflection) and we can say that the size of Z is determined by e alone. The reflected voltage is determined by four factors: The reflecting power of the target, the distance to the target, the amount of radiation directed toward the target, and the

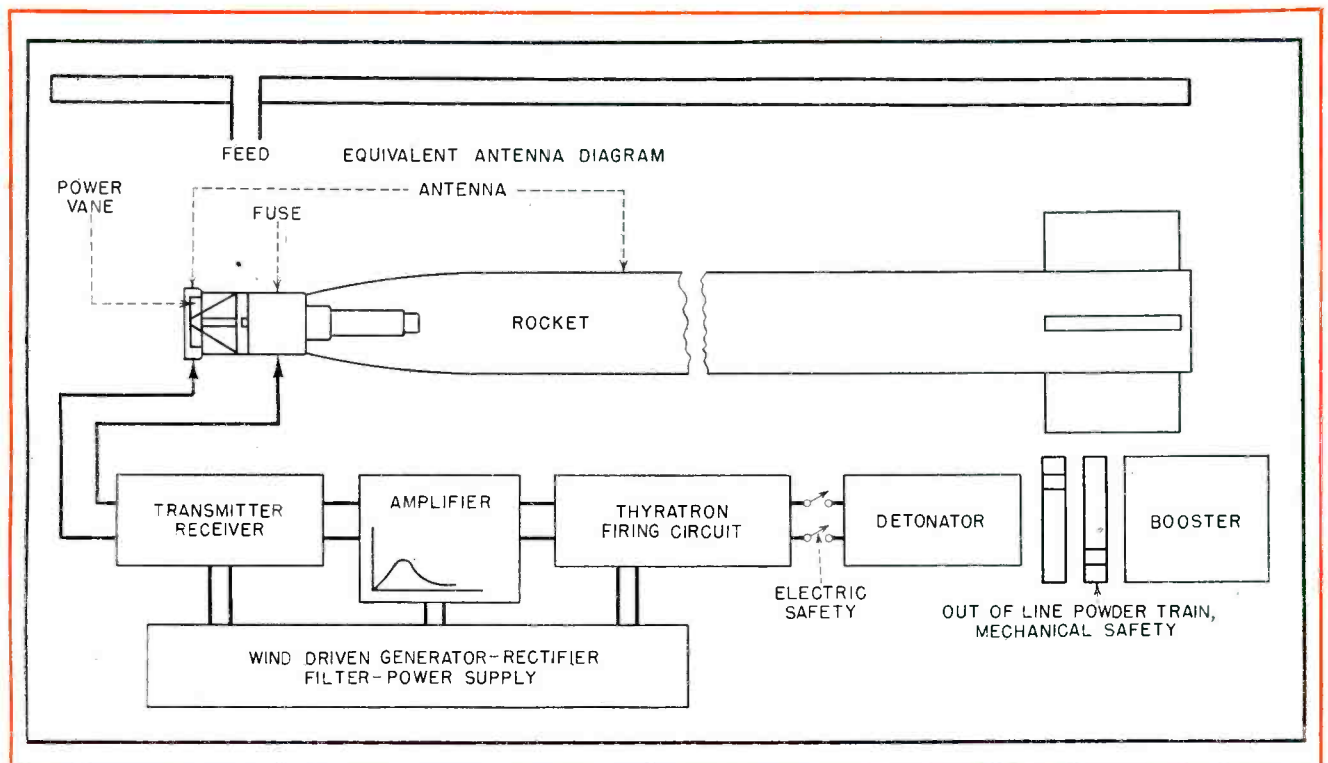
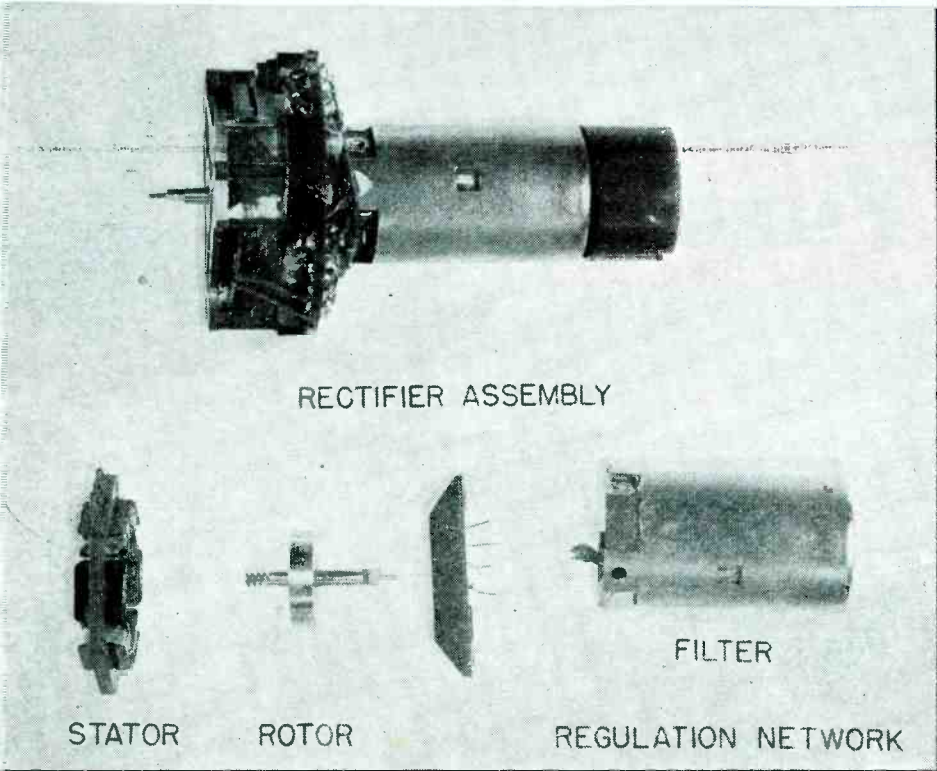

FIG. 1—Block diagram, showing at the top that the rocket constitutes a near-end-fed antenna. The electronic fuze fits into the nose of the rocket, and operates as shown to ignite a booster which fires the explosive charge



Separate parts of the wind-driven generator power supply for electronic fuse

receiving properties of the antenna for waves reflected back from the target. The first factor has been experimentally determined and found to be adequate. The second depends upon field strengths from antenna and target which decrease with increasing distance. The remaining two need further explanation.

Antenna Impedance Variation

The amount of radiation reaching the target is determined by the radiation pattern of the rocket antenna and the power radiated. Because an antenna has the same directional properties when used for receiving or transmitting, the ra-

diation pattern is the same in each case. The square of the radiation pattern and the total radiated power thus determine the size of Z . In fact, it can be shown that the total radiated power is so related to Z_0 that Z is proportional to R_1 , the resistance component of Z_0 , no matter what the radiated power may be. Finally, then, the size of Z is determined by R_1 and the radiating properties of the antenna, other things being equal.

The square of the radiation pattern is called the directivity pattern, the figure-eight loop around the rocket in Fig. 3 being the envelope of a typical pattern. The actual directivity envelope in space

is a figure of revolution about the axis of the rocket, roughly a doughnut-shaped figure. This envelope shows how well the fuze sees targets in various directions. With the figure-eight envelope the fuze sees mainly to the sides and not at all straight ahead, thus good shots are not detonated before they reach the target.

Figure 3 represents the situation when a rocket passes an airplane. The dotted curve plotted along the rocket trajectory and marked M -wave represents the idealized resistance component of Z at successive points.

Now $v = V_0 \sin\theta$, and $f = (2v\sin\theta)/\lambda$ if V_0 is the speed of the rocket in a coordinate system attached to the target. As the fuze approaches the target the size of Z grows rapidly because the distance shortens and the directivity improves. The rotation of Z slows down from the value $f = 2v/\lambda$ at large distances to the value $f = 0$ at the instant $\theta = 0$.

This analysis indicates that the characteristics of the reflected impedance are rapidly growing amplitude and rapidly falling frequency as the fuze approaches, and the reverse as it passes beyond the target.

Utilization of Varying Antenna Impedance

Advantage is taken of the combined increase in amplitude and decrease of frequency to cause the burst to occur in the ideal position. By incorporating proper shaping in the amplifier, the overall effective directivity pattern is made much

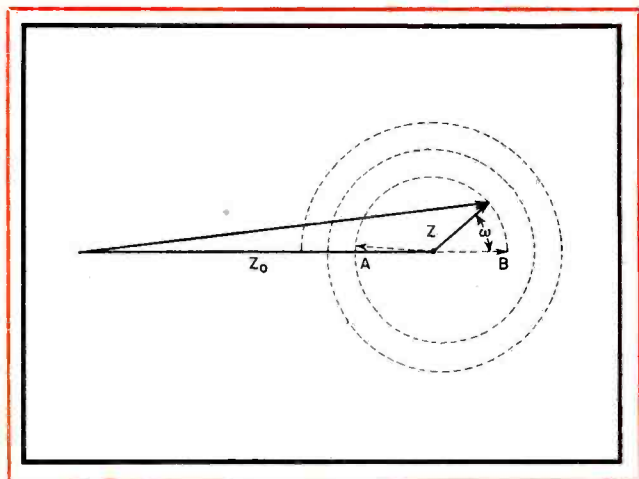

FIG. 2—Vector representation, showing the frequency and amplitude changes of antenna impedance

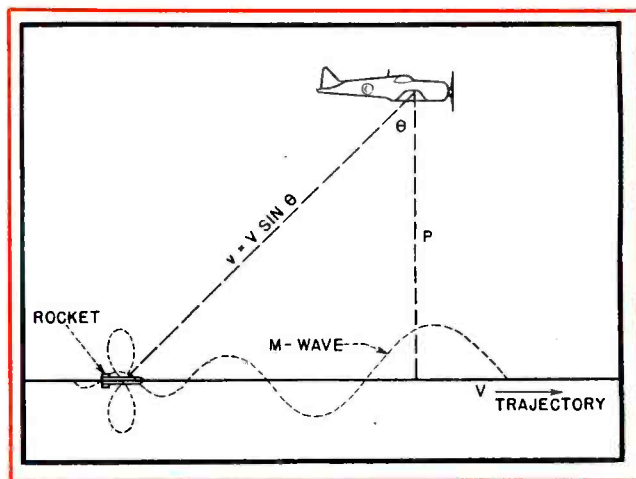

FIG. 3—As the rocket approaches its target the radiation resistance varies

sharper than that due to radiation alone. Figure 4 indicates the effect. By combining amplifier characteristics and radiation characteristics it is possible to draw an effective directivity pattern which is a locus of burst points.

To obtain proper operation, it has been found by experience that the fuze must burst when Z is a very small fraction of R_A . The fact that the fuze operates on a percentage change in antenna impedance implies that fuzes will function at a certain distance from a reflector without regard to the power radiated. Although fuzes have been made which work over a range of power levels as large as 5000 to 1, high power is desirable because it produces strong signals, strong reflection, and reliable operation.

Sensitivity of Transmitter-Receiver

When the effect of the reflecting target is expressed as a change of antenna impedance as outlined above, it is easy to see how a single tube can transmit continuous waves, receive the reflected signal, and select the low-frequency component.

The oscillator shown in the functional block diagram of Fig. 5 sees a variable load which changes periodically from increased resistance to increased reactance to decreased reactance to decreased resistance. If the plate circuit of the oscillator is tightly coupled to the antenna, the small reactance changes will alter the frequency of oscillation with but little effect on oscillator performance. The changes in resistance, on the other hand, alter the power drain on the oscillator, and certain parameters associated with the oscillation will follow these load variations. Thus the detected output voltage will have in it an alternating component of frequency $f = 2v/\lambda$ which can be selected and used as a working signal.

The design of an effective r-f oscillator which will give a strong, stable response to small load changes is based upon a figure of merit known as the sensitivity S and defined by the relation

$$\Delta V = S \Delta R_A / R_A$$

where ΔV is the change in detected output voltage, ΔR_A is the

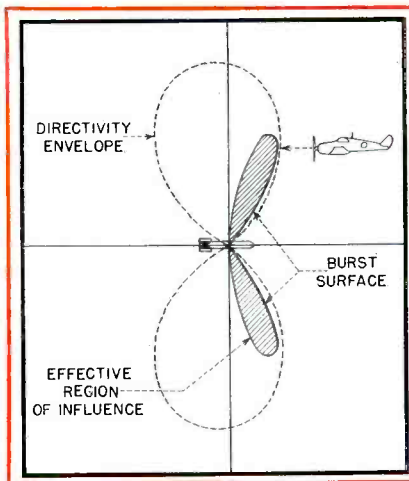

FIG. 4—By means of wave-shaping circuits in the fuze amplifier the effective influence region is modified as compared with the radiation pattern

resistance component of Z ; and R_A is the resistance component of Z_0 . Usually R_A is equal to Z_0 because the antenna circuit is tuned to resonance.

To predict the performance of a transmitter circuit a typical curve of V vs $\log R_A$ is plotted as in Fig. 6 for various values of R_A . The slope of this load curve gives the values of S for small values of $\Delta R_A / R_A$ corresponding to the radiation resistance R_A of any antenna that may be connected to the r-f circuit. The curve labeled S shows the sensitivity of the circuit at each value of R_A . It is important to note that S

is relatively independent of R_A over a large range. This independence of S with load changes means that the circuit is usable on a variety of antennas. The particular oscillator selected combines high efficiency with a large stable S which is relatively independent of tube parameters and load resistance.

One of the most important problems to be overcome in fuze production was the design and development of a triode oscillator tube that would give good power output with relatively small plate supply voltage, have a good S value, and operate in a simple circuit so stable microphonically that the small available signal would not be masked by vibration of the projectile during its flight at supersonic velocities. The resulting tube is similar in appearance to a standard hearing-aid type but more rugged in construction. In rocket applications, tubes are subject to accelerations of only 30 to 150 g, but the tubes developed to withstand the vibrations encountered were found sufficiently rugged for use at accelerations as high as 10,000 g.

Owing to limited space, highest efficiency of the oscillator is necessary to insure strong reflected signals and reliable operation. For small reflections, ΔV is proportional to ΔR_A , and the M -wave (Fig. 3) can represent the approximate wave

Bomb armed with electronic proximity fuze. It detonates above the ground, spraying fragments into dugouts and gun emplacements more effectively than contact-detonated bombs

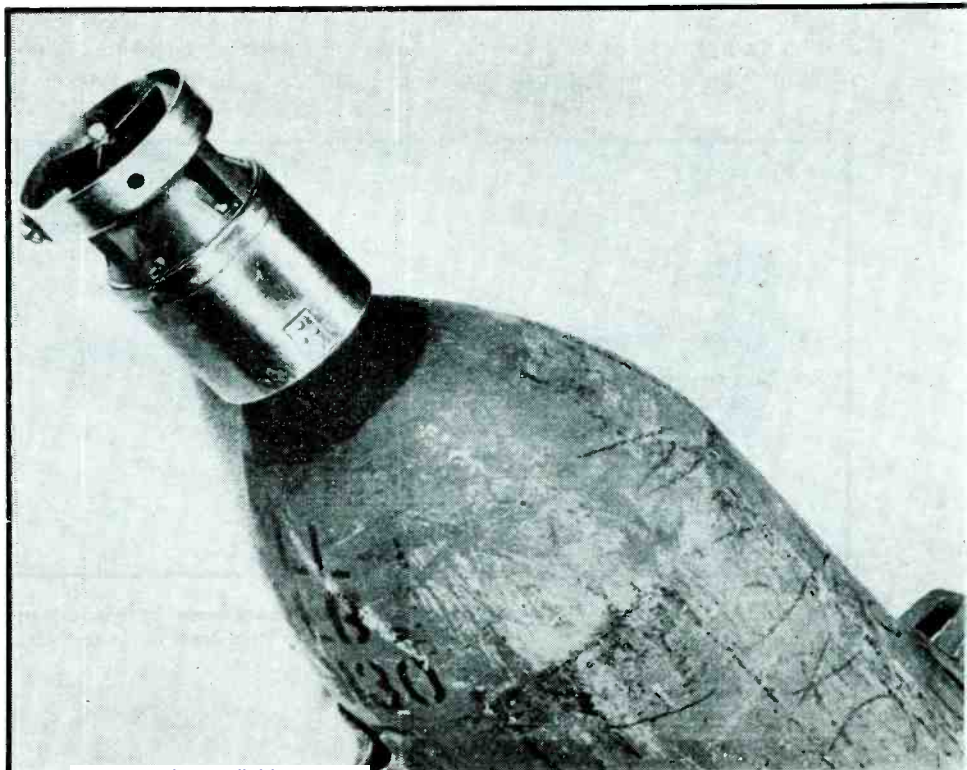

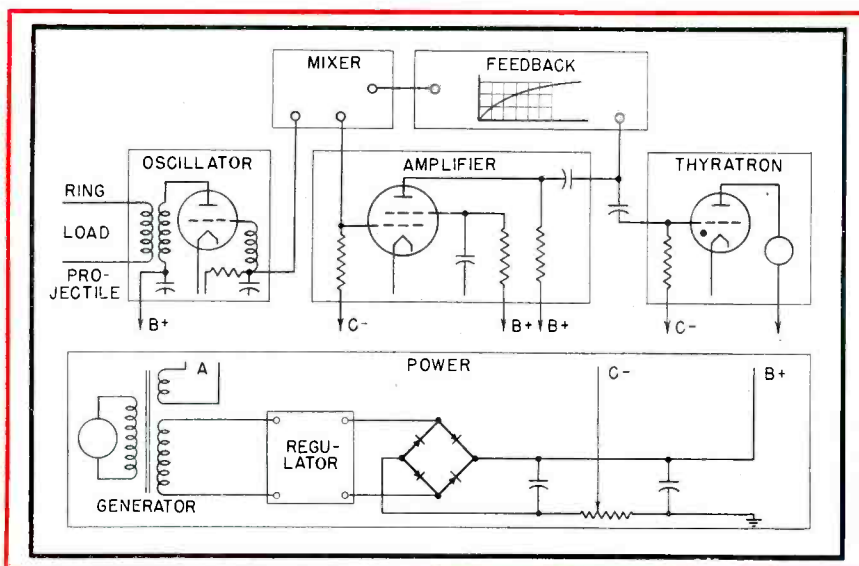

FIG. 5—Break-down of typical radio fuze circuit

form into the amplifier, as well as the variation of antenna impedance.

Signal Amplifier

Because the signal from the r-f section is too small to actuate a firing device directly, it is necessary to amplify it until it can reliably operate a thyratron.

The amplifier also performs important secondary functions. The shape of its gain characteristic assists the directivity pattern in properly locating the point of burst, and much of the tube microphonic noise, and filament a-c hum are suppressed by proper design. It is possible to make a single tube perform all these functions although there are limits to the amplification that can be obtained stably by a single tube while performing all of them. Dependence is

placed upon the high stable *S* of the oscillator and, for discrimination, upon feedback.

The amplifier (Fig. 5) is conventional in every respect, using a small tube especially designed for high gain. The feedback network gives regenerative feedback at the desired frequency plus high degenerative feedback at high frequencies and no feedback at low frequencies. The consequent sharp cut-off at noise frequency suppresses tube microphonics and hum.

Hum Problem

Currently available heater-type tubes warm up too slowly and are more microphonic than the filamentary type, so directly heated filaments are used. Because of generator design requirements, a-c is used on these filaments, thus creat-

ing a very serious hum problem.

The r-f section puts out hum at filament frequency with an amplitude many times larger than the working signal which must be separated from it. If discriminating networks are connected to the output of the amplifier, it is overloaded by the larger hum input and the gain at signal frequency is greatly reduced. Discrimination at the input is possible but requires considerable circuit complexity.

So the amplifier is made strongly degenerative at hum frequencies. Thus, to suppress one volt of hum input, the amplifier only has to generate slightly more than one volt output which is fed back out of phase to the input where it cancels the hum from the r-f section. The net result is amplification at signal frequency very much greater than at hum frequency. The output signal-to-hum ratio is thereby made high enough to provide an ample margin of safety for proper operation.

Every stage in the fuze circuit must operate at its optimum power efficiency. Although there is more than sufficient power to drive the generator, the limitations of space prohibit a large generator. Also the number of separate stages that can be added is restricted.

Burst Location

The frequency of maximum gain is selected by trial to give proper burst location. As the fuze approaches the target the frequency first received is too high and the gain too small to actuate the de-

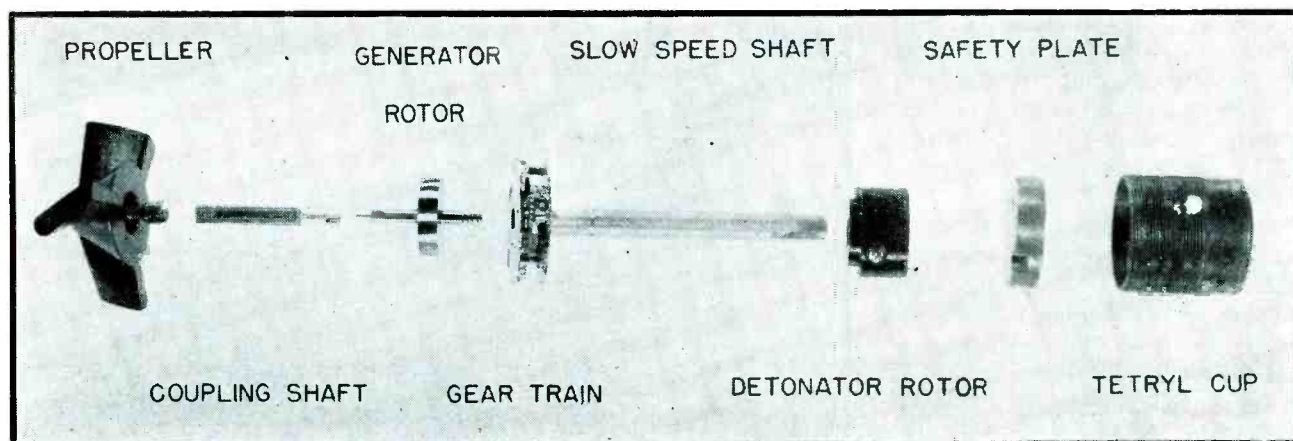

Safety devices, operated in sequence, by wind-driven propeller shaft, arm fuze after a rocket is fired from under the wing of an airplane

tonator. When it gets closer the output of the detector increases because the target is in a better position to be seen, and the frequency is lower where the gain is higher. The combination of these factors makes the region of influence around the fuze more sharply defined than the directivity envelope alone would indicate.

When the output from the amplifier exceeds its critical value, the fuze functions and bursts the projectile. The actual explosion is initiated by the discharge of the final capacitor of the filter through the thyatron and a detonator similar to a blasting cap. Thyatron bias is a factor in determining the location of the burst.

The detonator ignites a powder train which in turn sets off the booster to explode the main charge. About one millisecond elapses between the firing of the thyatron and the moment fragments start leaving the projectile, during which time the missile has moved very little. Despite its small size, the thyatron is capable of repeatedly passing large peak currents, without changing its characteristics, allowing proper factory tests.

Power Supply

The use of a battery, even of the reserve type, seriously limits the utility of a rocket fuze. It must supply proper voltage after being carried aloft to very low temperatures (-40 C) and at present there is no acceptable battery which will meet both the severe temperature and space limitations. There is no spin and little acceleration in a rocket to actuate a reserve battery.

Because more power can be obtained for a given volume by using a generator than by any battery yet available, design of a small wind-driven generator was undertaken.

The power system consists of generator, regulator, rectifier and filter. The generator rotor is a small, permanent magnet and the stator is a series of coils. Separate filament and plate windings are provided. Raw a-c is used for all filaments. The plate voltage is rectified by a small selenium bridge rectifier and filtered by an R-C circuit.

Bias voltage is obtained by the plate current drop in the filter and is adjustable to afford some compensation for production variation from generator to generator.

The large internal impedance of the generator serves two functions; it materially assists in the filtering action and it makes voltage regulation easily attainable. By adding a regulating circuit to the generator the variation of voltage with speed can be reduced almost to zero over a wide range of speed.

Figure 7 shows a typical speed-regulation curve. Achieving such a curve requires a careful selection of combined generator-regulator-filter parameters such that the best compromise on all values is obtained to reduce variations in mass production to a minimum.

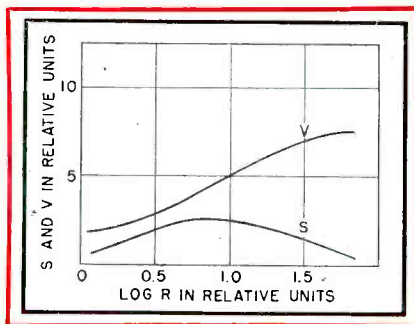

FIG. 6—Sensitivity varies so little that the fuze can be used in a variety of projectiles, i.e., with different antennas

An important secondary feature of the generator is its contribution to fuze safety. There is no power to actuate the mechanism unless it is flying through the air. Likewise, fuzes are inert once the generator stops spinning.

An incidental advantage of generator operation arises from the gear-reduction arming that can be readily incorporated. Long air travel-to-arming-time ratio is feasible if desired as it is in certain applications such as ground-to-ground firing of rockets or howitzers.

Safety Devices

In addition to driving the generator, the wind vane drives a gear reduction system to actuate the safety devices. By proper selection of the gear ratio any desired safe interval can be incorporated into

the fuze. The slip of the vane is remarkably constant and the system can be used to adjust for any desired fixed air travel to the arming point.

As the propeller turns, a small, Bakelite rotor carrying the electric detonator slowly rotates. When it has turned so that it is in line with the powder train, the final connections to the circuit are completed and the rotor is disengaged from the shaft. The fuze is then armed and ready for action. Until then the detonator is neither in the circuit nor in line with the powder train, thus giving dual safety.

Production

The fuze must be small. Small tubes and small generators have been mentioned. Without other

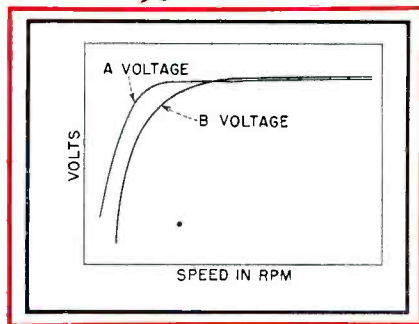

FIG. 7—Good regulation with varying generator speed is obtained by choice of generator and filter impedance

small components the device would still be impossibly large. The electronic industry has successfully supplied small resistors, capacitors, coils and rectifier cells; all strong, temperature resistant and vibration free.

The production of fuzes required previously unheard of discipline at the assembly lines. One loose contact vibrating in response to noise can undo the work of the best components. Manufacturers responded magnificently in establishing mass-production facilities despite the stringent inspections and heart-breaking rejections which were necessary to maintain adequate quality in the final product.

This paper is based upon the work of the Fuze Development Staff, Ordnance Development Division, National Bureau of Standards, under the direction of Harry Diamond. The program was conducted under the sponsorship of Army Ordnance Department and Division 4, NDRC.

The SCR-584 Radar

Details of the r-f system and receiver of the outstanding anti-aircraft gunfire-control radar, including hitherto unpublished information on microwave plumbing, rotating joints, crystal mixers, t/r tubes, and gated i-f amplifiers. Operating principles and specifications were given last month

The radio-frequency pulses generated in the cavity magnetron of the SCR-584, as described in the first installment (ELEC-

TRONICS, November, 1945, page 104), are conveyed to the radiator by a system of microwave plumbing and components known as the r-f

system. The echo pulses received from the target are conveyed from the radiator to the receiver through the same system. In this article,

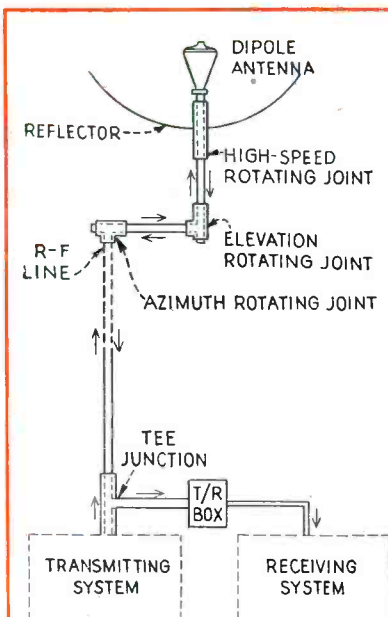
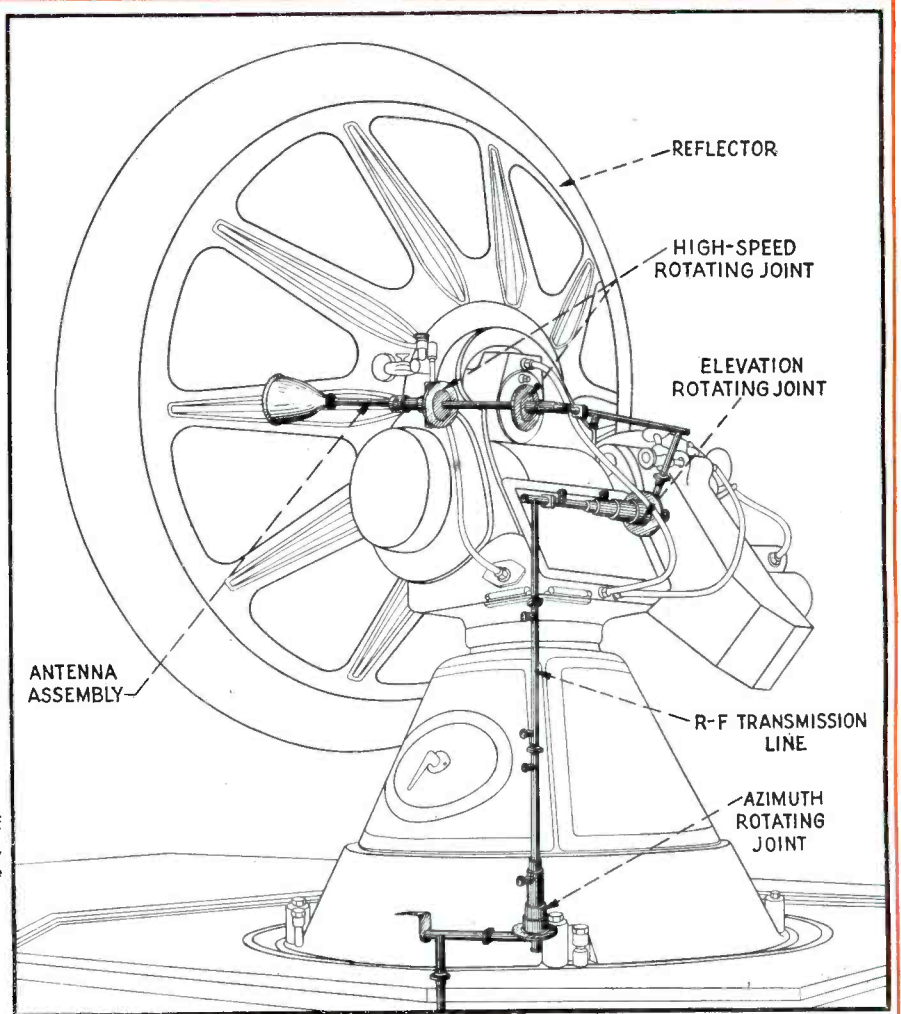

FIG. 1—Block diagram of the r-f system, by which the transmitted pulses and echoes are conveyed to and from the radiator

FIG. 2—Perspective view of the r-f transmission line and rotating joints, from magnetron output to dipole radiator



Closeup of antenna and platform of radar set SCR-584, partly raised out of the trailer. When in operation, the platform is up flush with the roof of the trailer

the details of the r-f system and receiver are described.

Basic Functions of the R-F System

The essential components of the r-f system are shown in the block diagram in Fig. 1 and in perspective in Fig. 2. As the r-f pulse leaves the transmission system it encounters a T-junction, which joins three coaxial lines. One branch leads to the radiator. En route the signal passes through three rotating joints. These joints permit the radiator to move in azimuth and elevation for helical scanning, and permit the dipole radiator to be spun about the axis of the paraboloid, for conical scanning.

The remaining branch of the T-junction leads to the receiver. In this branch the transmitted signal encounters the t/r (transmit/receive) box, a low-pressure gas discharge tube which breaks down and prevents passage of the strong transmitted signal to the receiver. At the conclusion of the transmitted pulse, the t/r gap deionizes, and the echo signals thereafter received are passed to the receiver. Coincidentally, the impedance of the cavity magnetron changes, so that the echoes are reflected from the transmission system with but minor loss due to absorption.

The transmission lines themselves are of the coaxial variety, with the inner conductor supported at intervals by quarter-wave stubs. The diameter of the inner conductor is increased at the stub, and for one quarter wave on either side, to increase the frequency band over which the stub support introduces negligible loss. A typical stub support and a joint in the line are shown in Fig. 3. The rotating joints are shown schematically in Fig. 4. Each joint consists of

quarter-wave overlaps between outer and inner conductors, within each of which is a small gap. The gap permits passage of the r-f energy, by capacitive action, while allowing free rotation of the joint about the axis of the line. Each joint is covered with a gas-tight seal which permits the lines to be filled with dry air under five pounds pressure.

Dipole Radiator

The dipole radiator is shown in Fig. 5. A plastic housing surrounds the assembly to contain the air under pressure. The coaxial line is surrounded, at the left, by a quarter-wave collar which converts the single-ended feed of the line to the push-pull feed required to excite the dipole. The inner conductor is built up to large diameter, as shown, thereby changing the impedance of the line so that it

matches the impedance of the dipole. The dipole itself consists of two rounded projections, one soldered directly to the outer conductor, the other connected to the inner conductor and projecting through a hole in the outer conductor. The two segments of the dipole are of different lengths so the radiation from it is slightly asymmetrical with respect to the axis line. As a result the axis of the beam is displaced from the axis of the paraboloid and as the dipole spins the beam traces out a cone

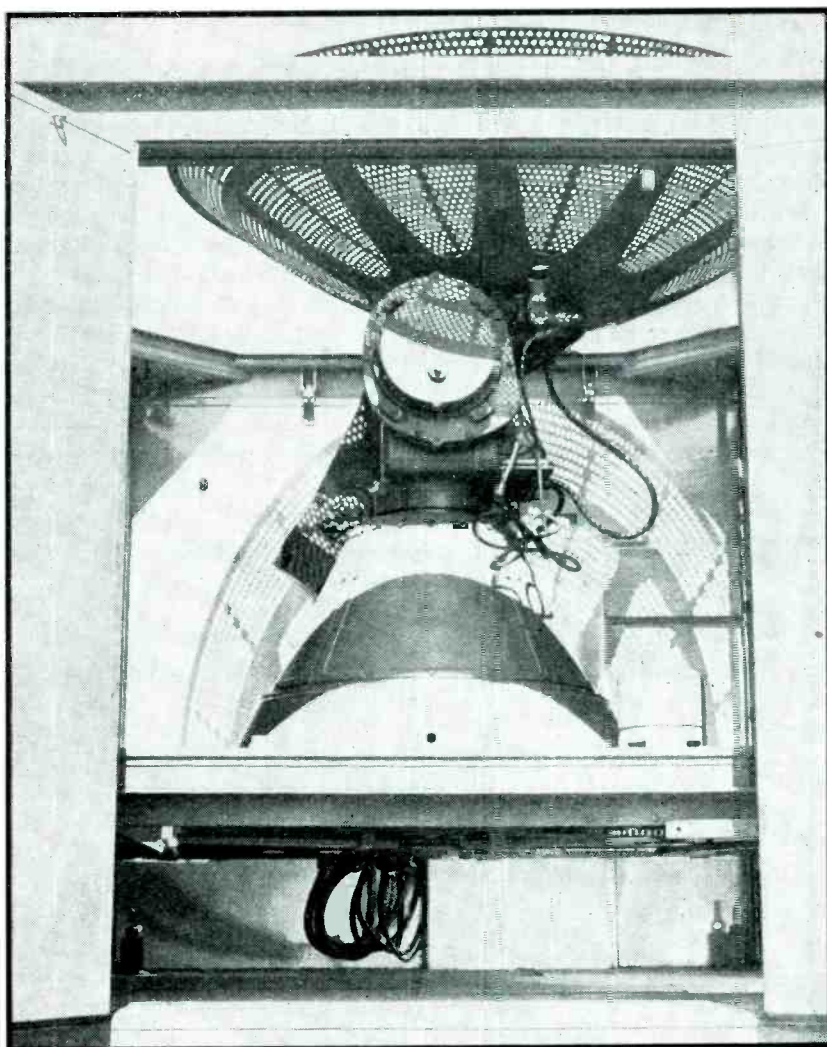

**electronics
WAR REPORT**

(conical scanning, see part I).

At the right of the assembly is a metal disk which reflects the forward radiation from the dipole, returning it to the reflector. This forward radiation would otherwise be largely wasted since it would spread outside the limits of the beam. The coaxial line is shorted at the righthand end, at such a distance from the dipole that the sig-

transmitted signal appears at the cavity input (through a coupling loop), the cavity is excited, and a high potential appears across the conical electrodes. Sufficient free ions are present in the tube (supplied by an auxiliary keep-alive electrode within the tube) to permit almost immediate ionization of the gap. The breakdown short-circuits the cavity and detunes it

receiver input circuit of receiver.

In the discharge condition, the t/r box introduces an attenuation to the transmitted signal of over 60 decibels, which reduces the power from 300 kw to well under 100 milliwatts. This level is small enough to be harmless to the receiver but sufficient to excite the receiver so the transmitted pulse is visible on the type J range scope. The power consumed in maintaining the gas discharge is negligible compared to the 300-kw level of the transmitted pulse.

The Receiving System

A block diagram of the receiving system is shown in Fig. 7. The echo signal is passed by the t/r box directly to the crystal mixer, where it is combined with a local-oscillator signal 30 mc higher in frequency. The 30-mc intermediate frequency is then amplified in two i-f stages (preamplifier) which are mounted directly adjacent to the crystal mixer. The remaining i-f stages are located (for convenience) at some distance, in the receiver proper. After the fifth i-f stage, the i-f channel breaks up into two branches, one (the range channel) feeding the indicators, the other (servo channel) feeding the auto-tracking circuits.

The circuits of particular interest in the receiving system are those which convert the carrier frequency to the intermediate frequency. Care must be taken in these circuits to maintain the noise level as close as possible to the inescapable noise level introduced at the antenna itself.

Crystal Mixer

The three most serious sources of additional noise, in order of importance, are the crystal mixer, the i-f amplifier and the local oscillator. The first two i-f stages are located as close as possible to the mixer stage to avoid losses at low level in the connecting cable. By attention to such details it has been possible to keep the noise in the receiver output to within 15 db of the theoretical level present in the antenna circuit.

The multi-grid converter tubes

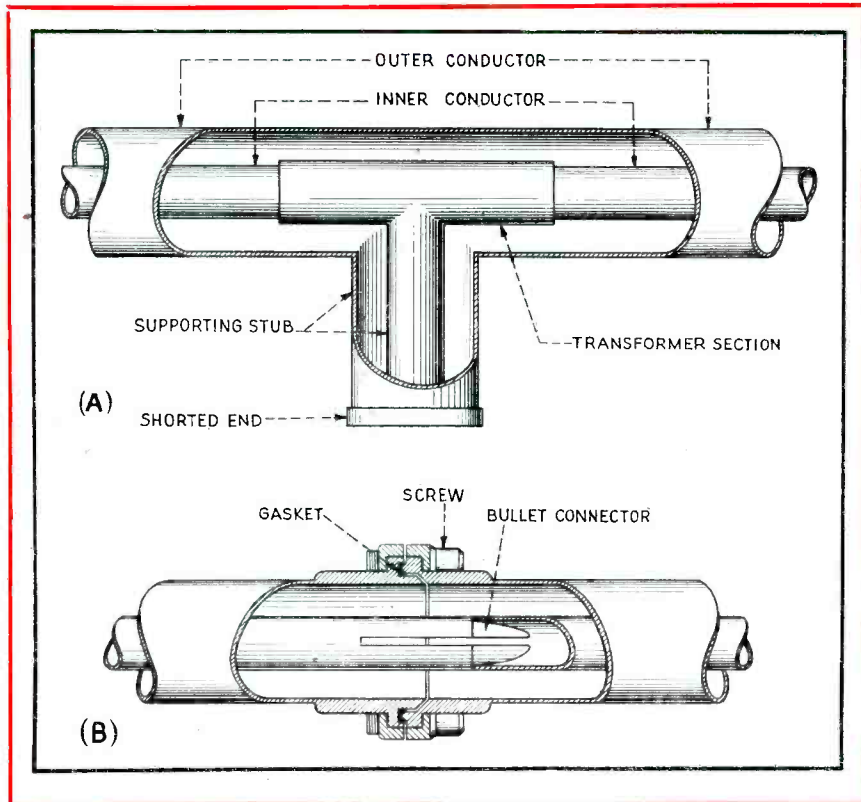

FIG. 3—Coaxial transmission line fittings: (A) broadband quarter-wave stub support; (B) in-line joint

nal reflected from the short appears in proper phase at the dipole to reinforce the radiated signal.

Transmit-Receive Switch

The t/r box (Fig. 1) is a device which permits the use of the same radiator for transmission and reception. Its essential element is the t/r tube (type 713A) shown in Fig. 6. This tube comprises two conical electrodes supported on metal flanges which extend through the glass envelope and become part of a resonant cavity (Fig. 6A). The cavity is tuned by tuning plugs to resonate at the carrier frequency. Consequently when the

so that the magnetic field within it collapses at once, and the signal is prevented from leaving the cavity via the output coupling loop. The tube is filled to a pressure of about 1 mm of mercury of water vapor, which ionizes in a few hundredths of a microsecond.

At the conclusion of the transmitted pulse, the gap deionizes (the recovery time is about 1 microsecond), and the cavity regains its tuned condition. Thereafter, when echo signals are received, they excite the cavity (but to such a low power level that the gap does not break down) and they are coupled through the cavity directly to the

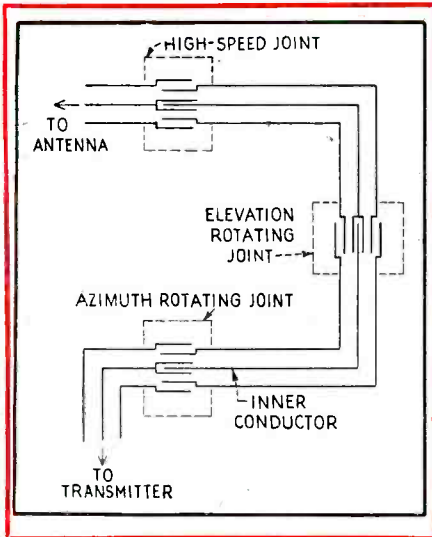

FIG. 4—Rotating joints. The r-f signal is transmitted past the air gaps by capacitive action

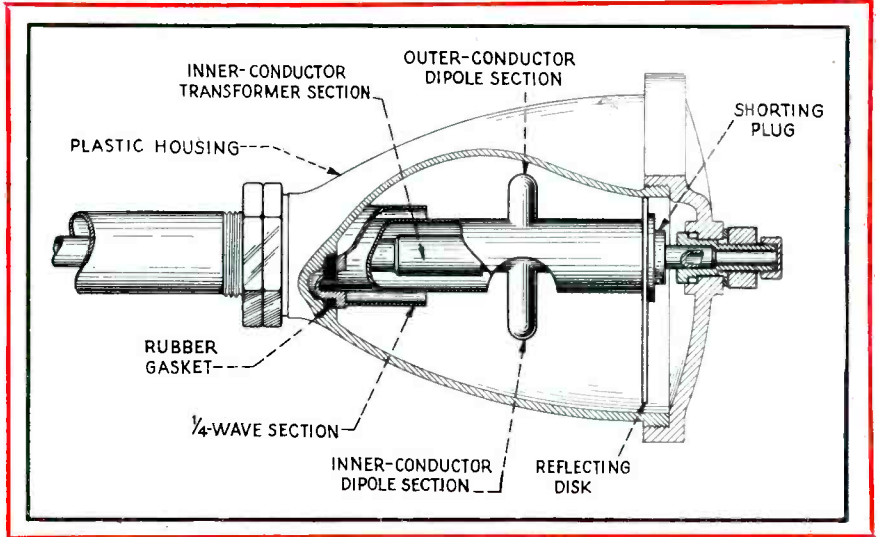

FIG. 5—Dipole radiator, transformer sections and reflector plate. A slight difference in the length of the dipole elements produces off-axis radiation for conical scanning

used in superheterodynes at lower frequencies are not suitable at microwave frequencies because of the noise introduced by random interception effects at the grid wires. The diode is accordingly chosen for microwave applications. The most efficient form of diode detector thus far uncovered is the silicon crystal. A slab of silicon, specially heat treated and etched, with a tungsten catwhisker bear-

ing upon it, is mounted in a small cartridge and the whole assembly filled with a plastic compound.

The cartridge is mounted in a housing, known as the mixer, shown in Fig. 8. The coupling loop at the lower left abstracts the received signal from the t/r box and passes it to the crystal. The local oscillator input, at a level of 25 to 50 milliwatts, is fed through the arm at the upper right, through a right-angle bend to a coaxial member whose inner conductor terminates near the crystal in a flat coupling plate. The level of the local oscillator signal is controlled by the screw adjustment until the rectified direct current passing through the crystal is about 0.6 ma.

The i-f output is developed between the base of the crystal cartridge and ground, and is fed

out through the arm at the lower right to a flexible coaxial cable which connects with the i-f pre-amplifier. In the output line is placed a small metal cup, insulated from the outer conductor by a thin section of mica insulation. The capacitance thus formed acts as a short-circuit at carrier frequencies and thus prevents absorption of the r-f signal in the i-f amplifier. The capacitive reactance is, however, 100 times as great at 30 mc as at 3,000 mc, so the bypass has relatively little effect on the i-f components. The mixer has no tuned elements and is constructed to operate without adjustment over the range from 2,700 to 2,900 mc.

Local Oscillator

The generation of c-w power at 3,000 mc, even in the small amount

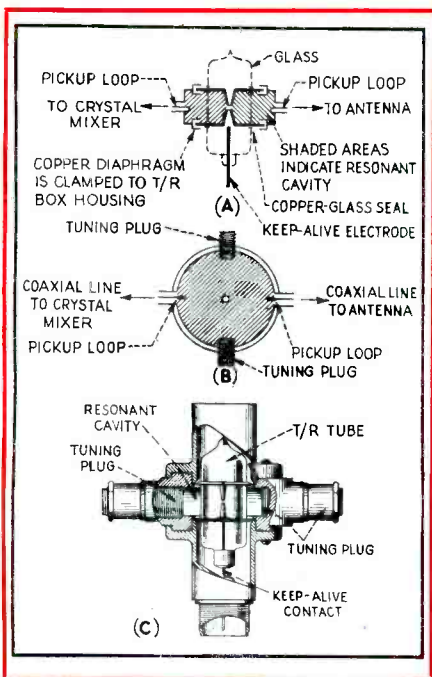

FIG. 6—T/r tube and resonant cavity. (A) Schematic view, side; (B) schematic view, top; (C) cut-away view

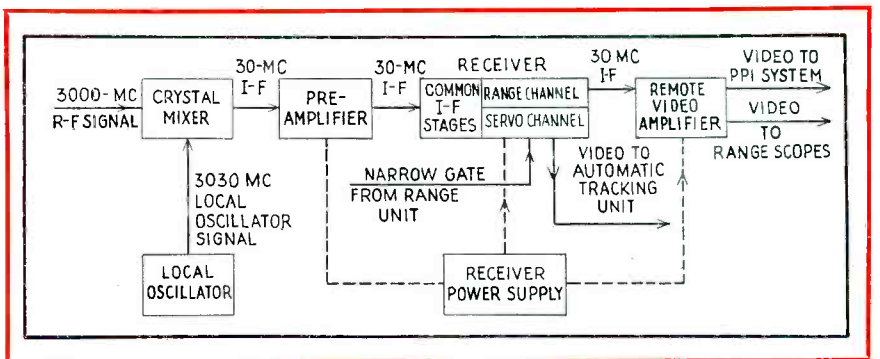

FIG. 7—Block diagram of receiving system. This system converts the r-f echo pulses at 3,000 mc to video pulses which actuate the c-r indicators and auto-tracking circuits

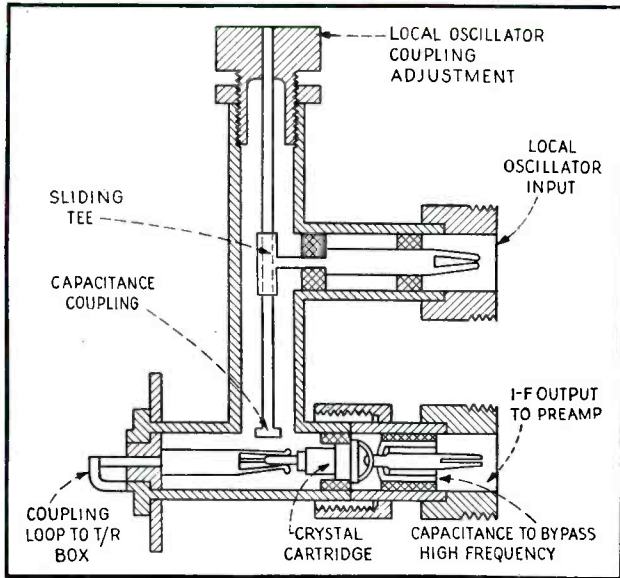

FIG. 8—Vertical cross-section of the r-f mixer. The local oscillator is loosely coupled to the silicon cartridge

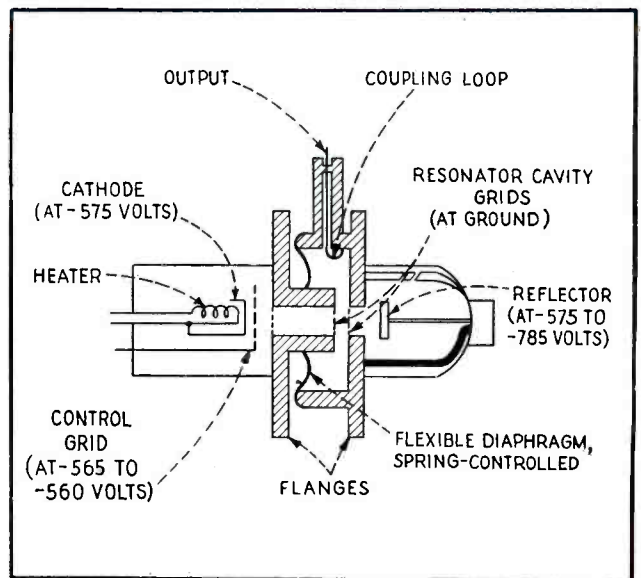

FIG. 9—Cross-section of the reflex klystron, used as a local oscillator in the receiver

required for local oscillator service, is a difficult task because of transit time limitations. To avoid these difficulties, the local oscillator tube employs the klystron principle to separate the effects of transit time from the oscillating circuit. The particular form of klystron used is a single-cavity type known as the reflex klystron, illustrated in Fig. 9. It operates as follows: Electrons from the cathode are formed in a beam and accelerated at about 575 volts. The beam passes within the center post of a cavity resonator and thence through two grids which are part of the cavity walls. The initial passage of the electrons causes a weak oscillation to be set up within the cavity, by shock excitation, and as a result the potential between the two resonator grids varies at the carrier frequency.

Electrons passing the gap thereafter find themselves alternately accelerated and decelerated by this variation in potential. On leaving the gap, the variations in electron velocity persist, with the result that the faster electrons catch up with those which pass unaccelerated, while the slower electrons fall back on the unaccelerated ones. In consequence, the electron stream becomes bunched, that is, more

dense in spots and less dense in others.

Meanwhile the electron stream encounters a decelerating d-c field applied by the reflector electrode (about -700 volts). This causes the electron stream to reverse its path, while the bunching process proceeds, and to re-enter the resonator gap. If the velocity of the electrons and the reflector potential are properly chosen with respect to the wavelength and the dimensions of the tube, the bunched electrons arrive back at the resonator gap just as the potential across the gap is such as to cause maximum retardation of the electron bunch. The electron bunch thereupon gives up a portion of its kinetic energy to the resonator.

As the succession of electron bunches re-enters the gap, the oscillations are successively reinforced until equilibrium is reached between the energy abstracted from the cavity (via the coupling loop shown) and the energy input to the beam less losses within the tube. Power levels in the hundreds of milliwatts are readily produced.

The frequency of oscillation depends not only on the natural period of the resonator, but also on the phase with which the returning

bunches enter the gap, and this phase may be changed by adjusting the voltage on the reflector electrode. This electrical method of tuning is employed to tune the receiver precisely to the transmitter frequency. The tube will oscillate at several values of reflector voltage; the most negative value is generally chosen. Care is taken to stabilize the accelerating and decelerating potentials applied to the klystron, to avoid electrical detuning. Care must also be taken to avoid feeding too great an output from the local oscillator to the crystal detector, since excessive power absorption by the crystal will injure the rectifying interface. The local oscillator is coupled very loosely to the crystal by the flat probe electrode shown in Fig. 8, not only to minimize this danger, but also to prevent absorption of the echo pulses in the local oscillator itself, which is tuned within 1 percent (30 mc at 3,000 mc) of the carrier frequency.

The I-F Amplifier

The i-f preamplifier is coupled to the mixer through a transformer, but thereafter the i-f stages are coupled by single tuned circuits, inductively tuned. The inductive ele-

Loran Receiver-Indicator

Circuit details and operation procedures of the navigator's equipment, which establishes the position of ships or aircraft by measuring pulse time differences, are described in this second article of a series

THE receiver-indicator of the Loran system, as stated in the first article of this series¹, measures the difference in the time of arrival of a pair of pulses, displayed on a c-r oscilloscope.

The oscilloscope sweeps are synchronized with the incoming pulses by an independent quartz-crystal oscillator adjusted by the operator to exact synchronism. The pulses are approximately 40 microseconds wide at the half-amplitude level. To match such wide pulses to an accuracy of one microsecond, it is necessary to superimpose the waveform of one pulse directly over the other.

The pulse-matching procedure is illustrated in Fig. 1, which comprises photographs taken directly from the screen of the Loran indicator. In Fig. 1A the horizontal

traces are sweeps each approximately 20,000 microseconds long, synchronized at 25 sweeps per second, or 15,000 microseconds long at $33\frac{1}{3}$ pps. The upper trace is referred to as the master or A trace because on it is displayed the pulse from the master (A) station; the lower trace is the slave or B trace.

The pedestal on each trace represents a portion of the trace which is later expanded to reveal the pulse shape. The master pedestal is fixed in position at the left edge of the master trace. On it is displayed the master pulse. The slave pulse then falls somewhere to the right on the lower trace. The slave pedestal, whose position is adjustable, is moved until it falls directly under the slave pulse. These steps are illustrated in Fig. 1A through 1C.

When the set is first turned on,

the pulses appear (Fig. 1A) in arbitrary positions, depending on the fortuitous phasing of the crystal synchronizing circuit relative to the incoming pulses. By slight adjustment of the crystal synchronizing frequency both pulses can be shifted left or right on the screen until the positions shown in Fig. 1B are found, i. e. with the master pulse on the master pedestal and the slave pulse below it and to the right.

The portions of the traces are then expanded (750- μ sec sweep) by changing the sweep speed, with the result shown in Fig. 1D. By a fine adjustment of the slave pedestal control, the lower (slave) pulse is moved so that it falls nearly under the master pulse, and by adjustment of the crystal synchronizing control, both pulses are shifted to the left

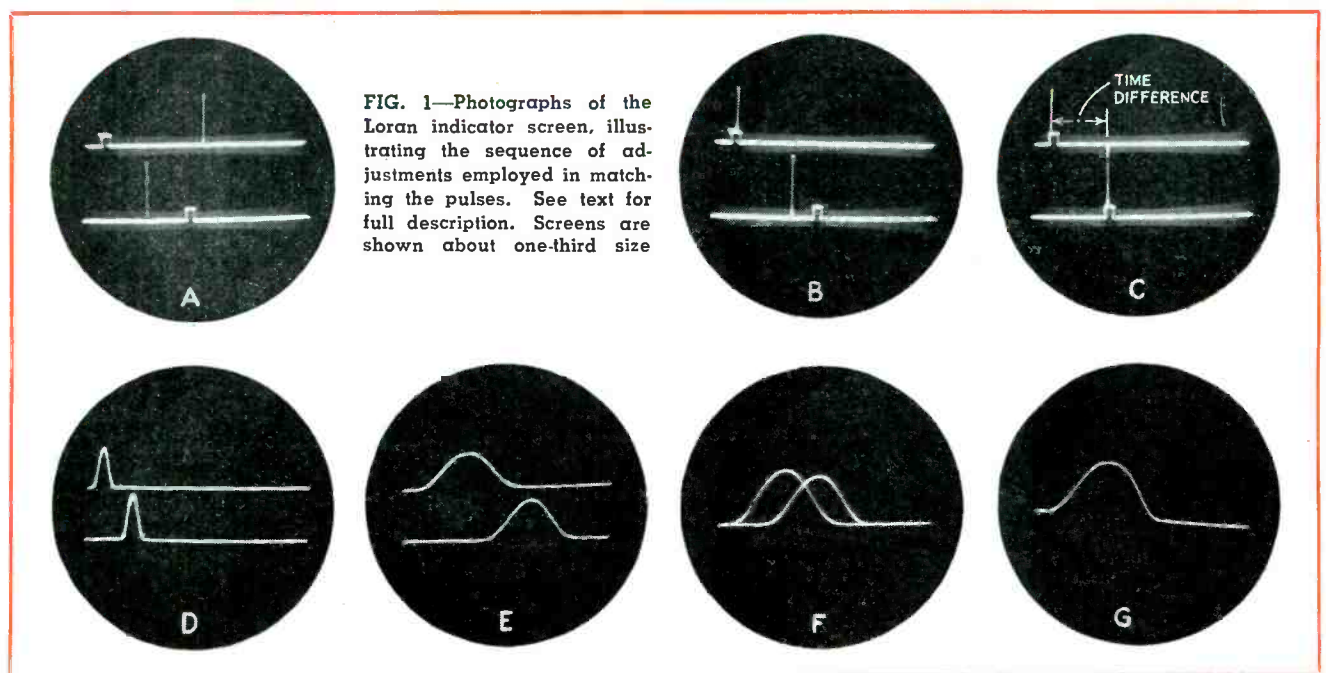

electronics WAR REPORT

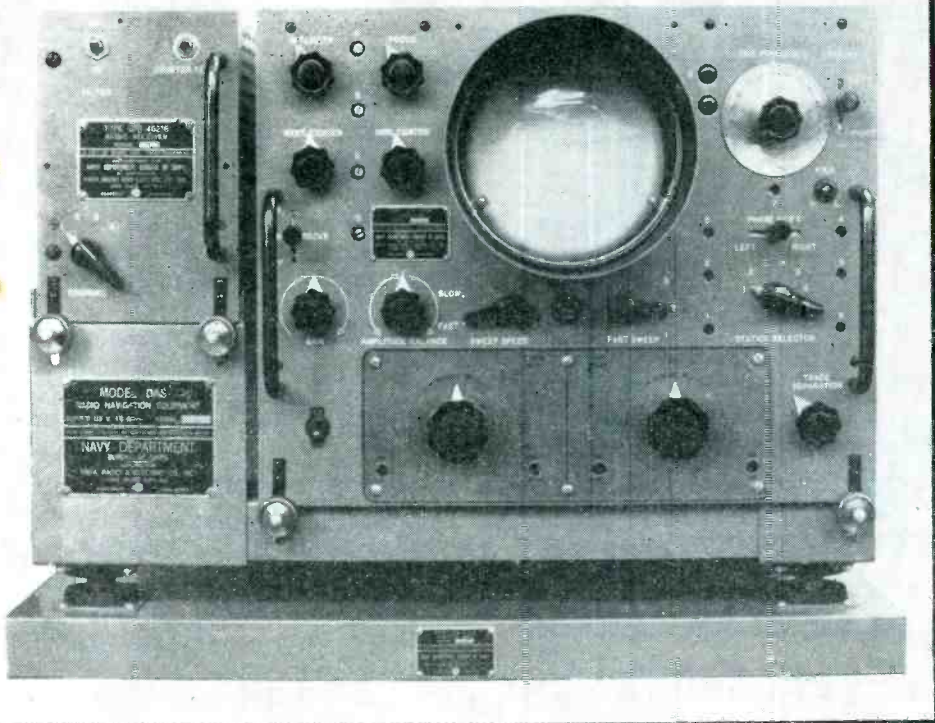

The DAS-3 shipborne equipment. Except for its greater size and weight this receiver-indicator is very similar to the AN/APN-4

of the traces, as shown.

A second expansion of the traces (200- μ sec sweep) is then introduced, as shown in Fig. 1E, and the two traces are then brought together (Fig. 1F). Any difference in the heights of the two pulses is corrected by a differential gain control. Finally, by further adjustment of the slave pedestal, the two pulses are brought into exact coincidence, as shown in Fig. 1G.

Reading the Time Difference

The time difference is measured by calibration marks, derived from the quartz crystal synchronizing circuit and imposed on the traces as shown in Fig. 2. By throwing a switch, after the pulse match of Fig. 1G is obtained, the pulses are removed and the calibration marks substituted. The time difference is read in three steps which indicate in succession the units and tens, hundreds, and thousands of microseconds.

In Fig. 2A the fastest sweep (corresponding to Fig. 1E) is shown with markers extending above and below each trace. The small upward markers indicate ten-microsecond intervals, and the larger downward markers indicate fifty-microsecond intervals. The units and tens are read by considering the lower trace as a scale and one of the upper

markers as a pointer, reading from a large marker on the lower trace to the next larger marker to the right on the upper trace. The time interval indicated is 24 microseconds.

The sweep is then contracted one step to 750 μ sec and the markers shown in Fig. 2B appear. The traces correspond to those in Fig. 1D. The largest downward markers mark 500-microsecond intervals. The hundreds of microseconds are read in the same manner as in Fig. 2A, that is, from a large marker

on the lower trace to the next larger mark to the right on the upper trace, counting in steps of 50. The partial time difference indicated is 350+ where the plus sign indicates the partial time difference previously read, 24 microseconds. Hence the total time difference, thus far measured to the hundreds, is 374 microseconds.

Finally the sweep is contracted to its original length, 20,000 μ sec, corresponding to Fig. 1C. The markers then appear as shown in Fig. 2C. Each trace is divided into groups of 2,500 microseconds. The thousands of microseconds are read from the upper pedestal to the lower, in groups of 500. The partial time difference indicated is 3,500+, where the plus sign indicates the partial time difference, 374 microseconds, previously measured. The total time difference is then 3,874 microseconds.

This apparently involved method of measurement is not so complicated in practice as it appears when described verbally. The complete process, indicated in Fig. 1 and 2, can be carried out in less than a

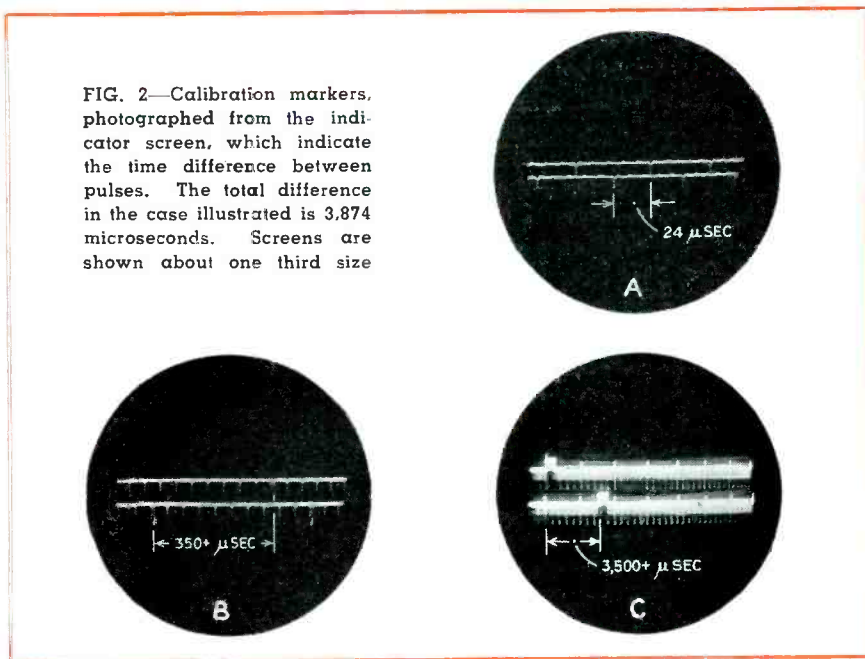

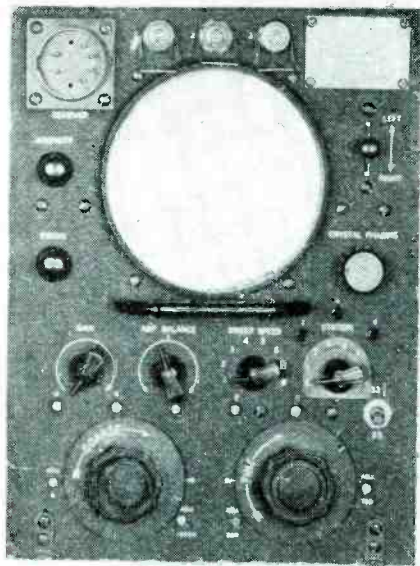
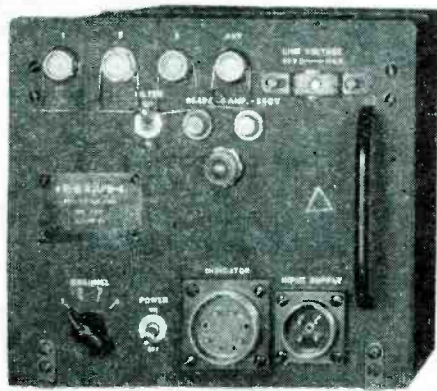

FIG. 3—Receiver (left) and indicator of the AN/APN-4 airborne receiver-indicator equipment. The sequence of patterns shown in Fig. 1 and 2 are obtained by manipulation of the indicator controls, as described in the text

minute by a well-trained operator, or in ten or twenty seconds by an expert.

The foregoing steps are then repeated on another pair of stations. The pulses from the second pair of stations are sent out at a slightly different pulse rate, (say $25\frac{1}{2}$ pps) but on the same radio frequency. Hence these second pulses are visible during the foregoing operations, but move rapidly across the screen, since the sweeps are not synchronous with them. The motion is sufficiently rapid that the second pair of pulses does not interfere

with the measurement of the first.

To measure the second pair, the sweep rate of the indicator is switched to the rate corresponding to the second pulse rate. The second pair then remains stationary, and can be measured as above while the first set is in motion. In some regions of the world, as many as 6 pairs of pulses, each pair on a different rate but the same radio frequency, can be seen simultaneously. The identification of the pair being measured is made by noting the rate at which the c-r sweeps are set. The sweep-speed switch is

marked with station-pair numbers which correspond with similar numbers marked on the Loran chart. The complete identification and time difference reading is given in several characters, a typical example being 1L1-3874. The figure 1 refers to the radio frequency ($1 = 1,950$ kc), the letter L to the basic pulse rate ($L = 25$ pps), 1 to the specific pulse rate ($L1 = 25\frac{1}{2}$ pps), and 3,874 is the time difference (typified in Fig. 2).

External Appearance

The external appearance of a typical airborne Loran receiver-indicator type AN/APN-4 is shown in Fig. 3. The smaller unit contains the receiver proper and the regulated power supply. The operating controls are the radio-frequency channel switch at the lower left (whose numbers correspond to the first digit in the identification symbol) and the power switch. The larger unit is the indicator, which comprises the c-r oscilloscope and its associated timing and sweep circuits. The two small knobs, upper left, control the brilliance and focus of the c-r trace. The toggle switch, upper right, introduces small changes in the crystal frequency and thus shifts the pulses to left or right. Below it is the crystal-frequency control knob which is adjusted to bring the sweep traces into exact synchronism with the incoming pulses.

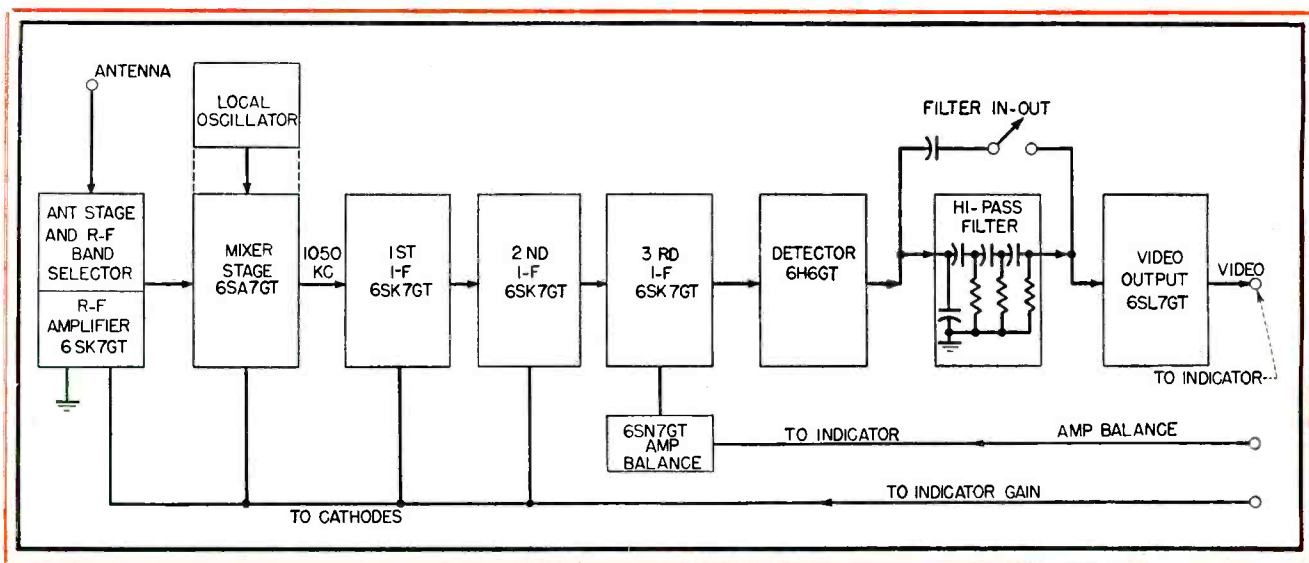

FIG. 4—Block diagram of the AN/APN-4 receiver. The circuits are conventional except for the differential gain control applied to the third i-f stage

The operating controls just below the c-r tube are overall gain, amplitude balance, sweep speed and station selector. The first controls the height of both pulses as they appear on the screen, whereas the second is a differential gain control which adjusts the height of one pulse relative to the other, as required in the matching procedure. The sweep speed selector introduces the successive changes illustrated in Fig. 1 and 2. The station selector selects the specific sweep rates to correspond to the discrete pulse rates of the different station pairs.

The two large knobs at the bottom are left to right the coarse and fine controls which shift the position of the slave pedestal in the matching procedure. The switch at the lower right selects the basic pulse rate, L for 25 pps and H for $33\frac{1}{3}$ pps. The various controls are so arranged and marked that a glance at the settings gives the first three digits of the identification symbol. The AN/APN-4 weighs about 65 pounds and consumes about 275 watts, 400-2,400 cps, 80 or 115 v.

Several other Loran receiver-indicators have been developed. The DAS-3, the basic equipment used by the Navy aboard ship, is somewhat larger and heavier, and has a different arrangement of controls, but is otherwise similar to the AN/APN-4. It operates on 60-cps power. The AN/APN-9 is a more recent version for airborne use. It employs a three-inch c-r tube and non-linear sweeps which make possible a reduction in the number of tubes in the indicator circuit. It weighs 35 pounds and consumes about 175 watts, 400-2,400 cps. The method of matching the pulses differs in detail, but not in principle, from that described here.

Details of AN/APN-4 Receiver

The receiver of the AN/APN-4 (Fig. 4) is a wide-band superheterodyne, employing three i-f stages. The 6SK7 r-f amplifier and 6SA7 mixer-local oscillator are conventional, being tuned by a switch which selects four channels at 1,750, 1,850, 1,900 and 1,950 kc. The three intermediate-frequency stages (type 6SK7 tubes) operate at 1,050 kc, and have a bandwidth of approximately 60 kc at the 6-db (voltage)

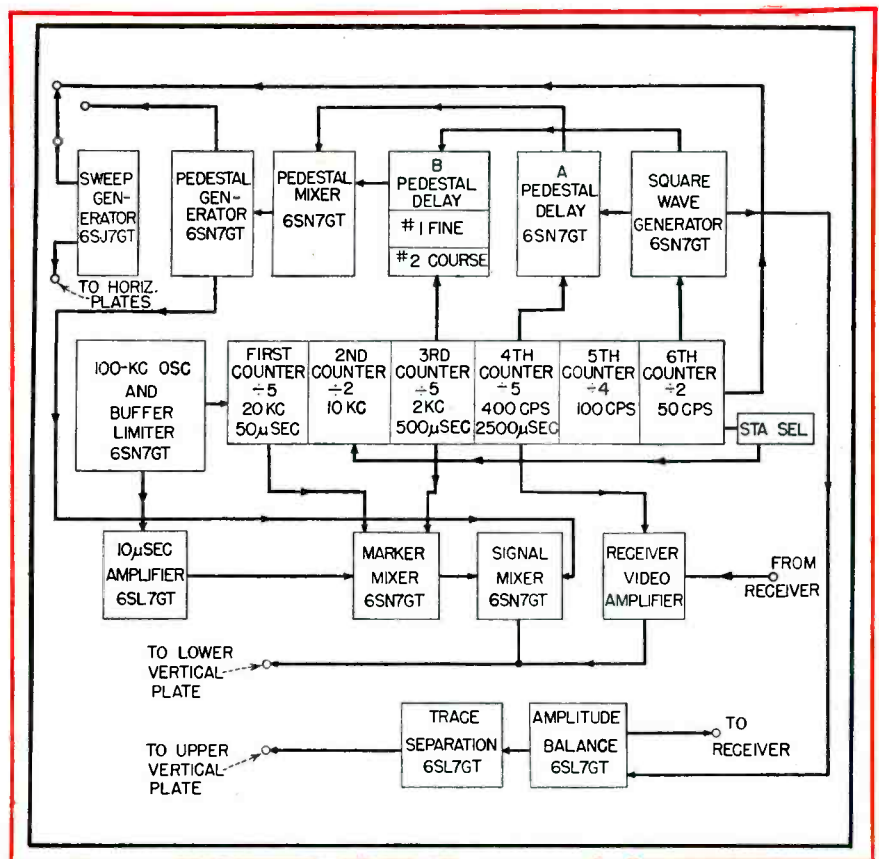

FIG. 5—Block diagram of the AN/APN-4 indicator. The 100-kc crystal timing source is converted by counter circuits to 25 or $33\frac{1}{3}$ cps rectangular waves which control the sweeps and pedestals

level. This bandwidth is somewhat narrower than the spectrum of the transmitted pulse, but permits reproduction of the pulse with the shape shown in Fig. 1G, with 40-microsecond width at the half-amplitude points. A 6H6 diode demodulates the i-f signal and transmits the pulses to the 6SL7 video amplifier, which feeds the indicator.

The cathode of the last i-f stage connects with the indicator from which is supplied a rectangular wave of voltage synchronous with the sweep traces. This rectangular wave passes through a cathode-follower stage and biases the last i-f stage on the negative half-cycles, thus reducing the gain of the receiver during the formation of one c-r trace, while allowing normal gain during the formation of the other trace. The amplitude and polarity of the rectangular wave are controlled by the amplitude balance control previously mentioned.

Two high-voltage supplies are contained within the receiver housing. One is a 2,600-volt low-current supply for the cathode-ray accelerating electrodes, arranged in two

sections of 1,300 volts each, above and below ground. The low-voltage power is supplied at 260 volts, accurately regulated.

Details of AN/APN-4 Indicator

The indicator circuits are illustrated in the block diagram in Fig. 5. The basic timing source is the 100-kc quartz crystal oscillator. Across the crystal is a small variable capacitor which permits small adjustments of the crystal frequency. From this 100-kc source, the sweep traces at 25 pps or $33\frac{1}{3}$ pps must be obtained together with the minor variations in these rates corresponding to the different specific pulse rates of the station pairs. The derivation of the 25 or $33\frac{1}{3}$ cps wave from the 100-kc source is accomplished by a series of frequency-divisor circuits. A total frequency division by 4,000 (in seven steps of 5, 2, 5, 5, 4, 2, and 2) is required to derive the 25-cps rate, and by 3,000 (5, 2, 5, 5, 3, 2, and 2) for the $33\frac{1}{3}$ cps rate. The first six divisions are performed by counter circuits, the last factor of 2 by an Eccles-Jordan scale-of-two circuit.

GEOPHYSICAL

Electronic circuits used today include variable-sensitivity amplifiers for the recording galvanometers, accurate time control for the recorders, and time marking for indicating the time and depth of shot that is fired to produce ground waves

By **DAVID SHEFFET**

*Stanolind Oil and Gas Co.
Tulsa, Okla.*

THE OIL INDUSTRY relies heavily on the electronics industry for many products. In the geophysical division alone there is a broad use of electronic components. At the present time there is an estimated annual expenditure for geophysical exploration of approximately four million dollars on the products of electronic manufacturers. Although this sum seems small compared with the astronomical output of manufacturers

during the war, it represents a steady reliable market which is not likely to be reduced by the advent of peace. On the contrary, the persistent search for new scientific methods and techniques by the oil industry is likely to broaden the demand for electronic components.

Prospecting Methods

Practically all geophysical exploration for petroleum at present

employs three basic methods of prospecting. These methods are seismic, gravimetric and magnetic. All three methods are used by oil companies in a complete exploration program. The gravity and magnetic methods are relatively inexpensive and fast in operation, and are used as reconnaissance methods to give a quick overall picture of an area. They do not provide accurate subsurface detail, but serve to outline general limited

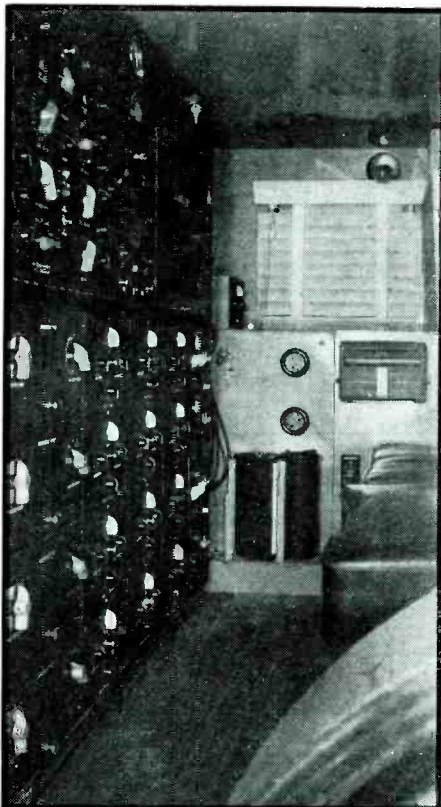

The recording equipment of the seismometer installed in the truck

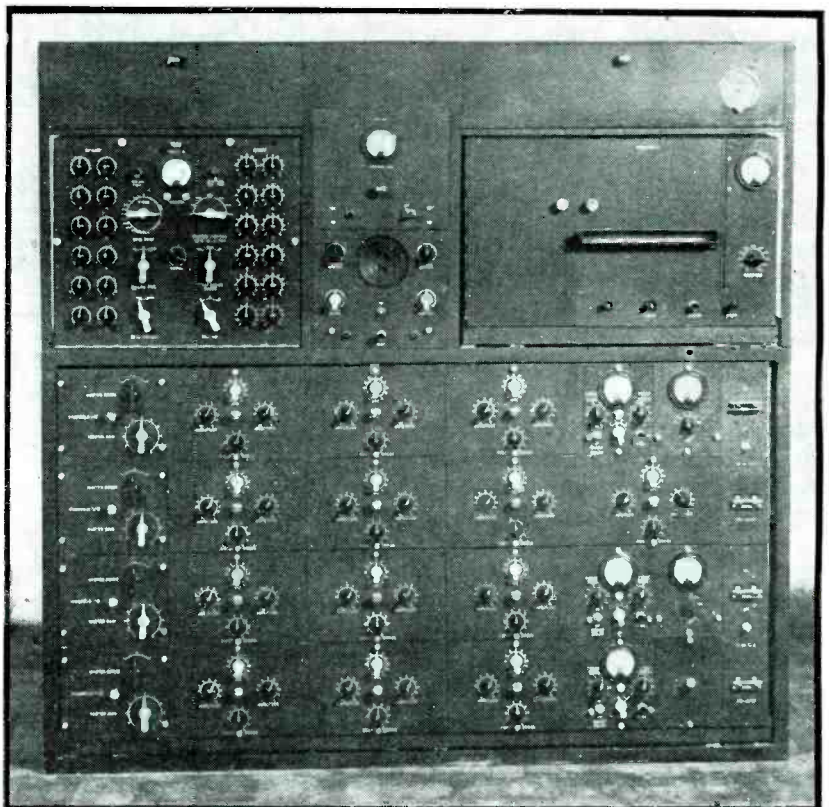

The operator's panel includes terminal positions from seismometer cables, electrical test set, timing circuits, amplifiers, recording oscillographs, and firing controls

PROSPECTING EQUIPMENT

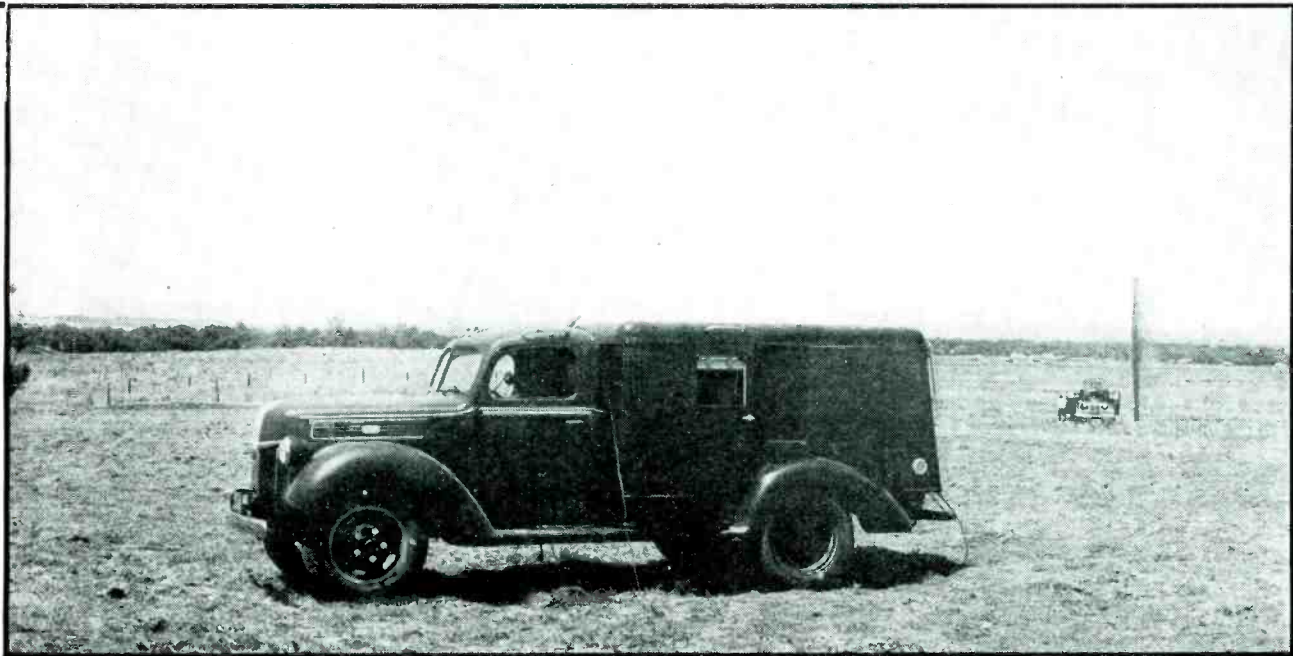

The truck for field surveys carries the recording equipment. In the background is the shooting truck beside a geyser of mud and water blown out of the hole as an aftermath of the shot

areas of interest which can later be more accurately delineated by the seismograph.

The gravity meter is an amazingly sensitive device for measuring the variations of the force of gravity with variation of geologic structure. However, all of its remarkable magnifying properties are obtained by means of mechanical and optical linkages. The electrical circuits involved are usually associated with simple relays for maintenance of limited temperature fluctuations.

The magnetic method involves the use of a magnetometer which is a combination magnetic, mechanical, and optical device for measuring the variations of the vertical magnetic field associated with geologic formations.

Of the three methods, the seismic method has borrowed the most from the electronic field. What is usually known as the seismograph actually is a system comprising a large group of earth-type microphones, cables, control circuits, amplifiers and a recording oscillograph. In addition, there are voice

communication circuits and shot-firing circuits. All this equipment is used to record the vibrations generated in the earth by firing a charge of dynamite below the surface. The acoustic waves initiated by the explosion penetrate the geologic formations and produce reflected waves at the boundaries between different media because of sudden changes in elastic properties (acoustic impedance) across the boundary zones. These reflected waves return to the surface of the earth and are recorded so as to indicate depth and dip of the various reflecting horizons.

Seismograph Field Spread

In a seismograph field setup, or spread as it is usually known, a group of 24 or more seismometers (ground-contact microphones) is placed on the earth in a line either running through the shot point or offset from it. The exact arrangement and number of these seismometers and configuration of the spread varies considerably between companies and between different areas surveyed by a given com-

pany. As few as 12 and as many as 96 seismometers have been used by some operators. The length of the spreads may vary from 200 feet to 3,000 feet. It is important in any spread to know the exact distances between seismometers and shot point because these enter into the final calculations of depth and dip of the subsurface strata.

Amplifiers

The seismometers connect through multiconductor cables to a control and test panel in the recording truck. This control panel feeds the outputs of the seismometer groups to a large number of identical recording amplifiers. These amplifiers connect to a multiple galvanometer recording oscillograph which records the output of each channel on sensitized photographic paper. It is common practice at present to use 12 or 24 amplifier channels and a single galvanometer block in the oscillograph, which contains a corresponding number of recording elements plus a spare.

There are many kinds of seismic

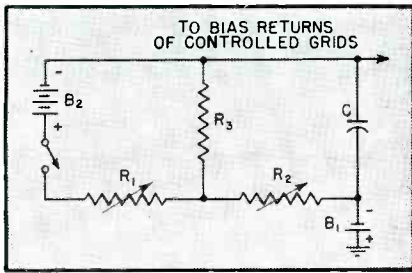

FIG. 1—Time-rate volume expander increases gain of amplifiers after the shot is fired

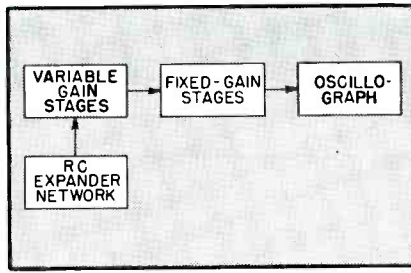

FIG. 2—To record all reflected signals at comparable amplitudes, gain is controlled by a time-rate expander

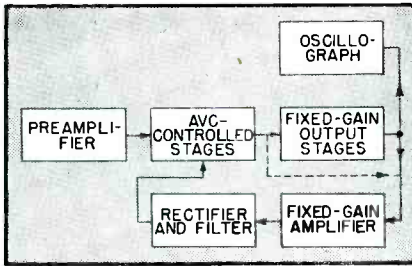

FIG. 3—For maintaining constant input to the oscillograph, avc can be obtained from the amplifier output

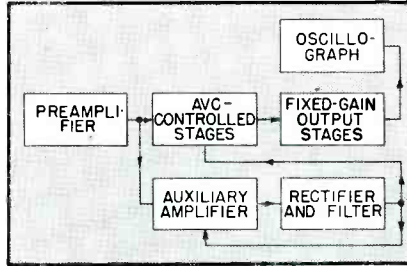

FIG. 4—A loop containing an auxiliary amplifier can provide over- or under-control for avc

amplifiers in use by geophysical companies. Most of them use automatic volume control or adjustable time-rate expanders or combinations of both. In seismic shooting the range of input signal which must be recorded varies as much as 10,000 to 1, according to the area worked. This wide amplitude range must be reduced to an average range of 2 to 1 or better at the oscillograph, and this must be done in a period that rarely exceeds four seconds and is often as short as one second. The threshold sensitivity of the amplifier should be adjustable in steps between one microvolt and one millivolt. This requirement means that when the amplifier is wide open, any signal above the threshold value of one microvolt will operate the automatic volume control. With the gain reduced 60 db, signals have to exceed the threshold of one millivolt to operate the avc. These are common requirements today for fully automatic volume-control systems.

Preadjusted time-rate expanders in which the gain varies with time are also used. In this system some variable gain elements such as remote-cutoff pentodes have their bias set at a predetermined level, thereby reducing the amplifier gain to the point where the initial high

output of the seismometers after the explosion is fairly well controlled. At a definite time after the initiation of the shot, the bias is reduced at a predetermined rate by a capacitance-resistance network so that the gain of the amplifier increases while the energy of vibrations from the earth is decreasing. It requires experience in each area to know just what rate of gain expansion is necessary to compensate for the decrease of shot energy and obtain a uniform record. This experience is not so necessary when using a truly automatic volume control, therefore many operators today employ automatic volume-control amplifiers.

Gain Control

Figure 1 shows a circuit of a resistance-capacitance expander network such as is used in the time-rate expander system given in the block diagram of Fig. 2. When the switch is closed, capacitor C is charged to a voltage determined by adjustment of R_1 . This voltage plus B_1 is the initial bias on the grids of the controlled tubes. The firing of the shot operates a relay which opens the switch; C discharges through R_2 and R_3 . R_2 is adjustable so that the rate of gain increase can be set to match the expected rate of decrease of

signal energy. Battery B_1 represents the final bias reached and determines the maximum gain of the amplifier when the capacitor has discharged.

One ingenious variation of the time-rate expander system uses the resistance-capacitance gain expander system, but the resistance that discharges the capacitance is not fixed during the period of the record. Instead, the resistance itself is electronically controlled by the average signal amplitude, so that the gain expansion rate is a function of the signal. This characteristic is like a one-way avc because the gain of the amplifier can increase when signal level decreases, but cannot decrease if signal level temporarily increases because the expander capacitor cannot recharge once it has started on its discharge cycle.

In the development of automatic volume control for seismic recording, the problem at first seemed simple because avc was already being used in radio receivers quite successfully. The thing that made it difficult was the fact that the major frequencies recorded were between 25 and 100 cycles. In radio receivers the stages controlled by the avc voltage operate at several hundred kilocycles or in the megacycle range. The rectified and partly filtered intermediate-frequency voltage which supplies the avc bias has no residual components that are likely to be amplified by the stages which it controls. Thus there is excellent protection against oscillation of the system at one of the fluctuation component frequencies.

Avc Problems

In a seismic amplifier the frequencies amplified are so close to the highest equivalent control frequency of the avc voltage that it is not a simple matter to obtain a wide amplitude range of control with sufficient speed of control and still maintain stability. The way in which the rectified avc voltage is filtered is very important. Too much filtering insures stability but reduces the rate of avc action. In some shooting locations this slowness does no harm but in others the avc cannot follow the rapid dynamic changes of the shot

energy. Too little filtering produces instability which may vary from intermittently-appearing low-frequency rolls to continuous low-frequency oscillation. It is even possible to get good stability when the shot energy is medium to high, but get low-frequency incipient oscillations when the signal input is low.

Not only is the method of filtering important, but the type of variable elements controlled by the *avc* voltage is equally important for successfully attaining smooth dynamic action with dependable stability. The obvious control elements are variable-gain tubes such as the 6K7G or 6U7G. In a single-ended amplifier using the signal output to supply the *avc* voltage, these tubes can be controlled over a reasonable range with fair dynamic action. The *avc* voltage can be applied either to the control grids or to the suppressors. When applied to the control grids, the filtering is usually more critical than when the *avc* bias is applied to the suppressors. If the gain in the *avc* loop exceeds unity at any frequency where the input and output are in phase, the system will oscillate.

Figure 3 shows a block diagram of a typical automatic volume control amplifier. In this figure the preamplifier is a fixed-gain amplifier. However, this amplifier may also have its gain varied with time as shown in Fig. 2 or it may be included in the *avc* loop along with the succeeding stages of Fig. 3.

Another type of *avc* that has been used is the input type of control shown in block diagram in Fig. 4. In this system there is no feedback of output signal to be rectified and filtered for *avc* bias. Because the bias is generated by the input signal through a separate amplifier,

the control action is independent of the output signal and consequently it is possible either to over-control or under-control the output. It is easily possible to produce zero output with a large signal input unless precautions are taken. One method of avoiding this effect is to let the auxiliary amplifier *avc* itself to a small extent.

The advantage of this system is absence of possible feedback in the controlled stages of the main amplifier and therefore reduction of the amount of filtering necessary in the *avc* filter. Thus greater speed of *avc* action is possible with good stability. The chief disadvantage of this system is that it requires careful matching of tube characteristics between the tubes in the main amplifier and in the control amplifier. If the tube characteristics vary with age it is possible to get both over-control and under-control on the same record. In the feedback or output control system of Fig. 3 a certain amount of tube variation can be tolerated because of the self-compensating characteristics of the feedback system. If the gain in the feedback loop should change with age or with power supply voltage variation, the worst that can happen is a uniform gradual under-control which does not show too badly except at large signal levels. It is impossible to over-control with an output control type *avc* system.

Electronic Variable Resistor

A method of control which is very popular in seismic recording makes use of electronic resistors as a part of an attenuator pad between amplifier stages. The 6H6 or 7A6 double diode can be used as an electronically controlled resistor with the *avc* bias voltage

supplying the control. This circuit is shown in Fig. 5.

In a diode the plate is so close to the cathode that some emission from the cathode flows to the plate without any external voltage being impressed on the plate. Not all electrons flow to the plate, but there are so many of sufficiently high initial velocity that they strike the plate in great numbers and we call the result a high contact potential. When no external voltage is applied between plate and cathode, the resultant electron stream can be used as a low resistance. Biasing the plate negatively with respect to the cathode reduces the electron flow and increases the plate-to-cathode resistance. The range obtained varies from about 1,000 ohms to several megohms. It is necessary to use a back-to-back arrangement of diodes in order to prevent distortion over a wide range of signal voltages. It is possible to use a single half-wave diode over a limited range of signal levels. Con-

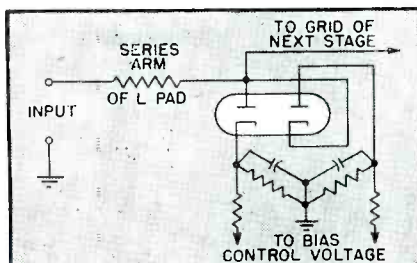

FIG. 5—Controlled duodiode is used as a variable resistance in an *avc* system

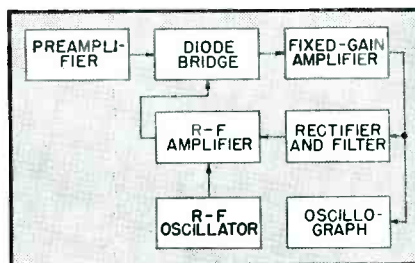

FIG. 6—A radio-frequency link can be used to control the diode resistor

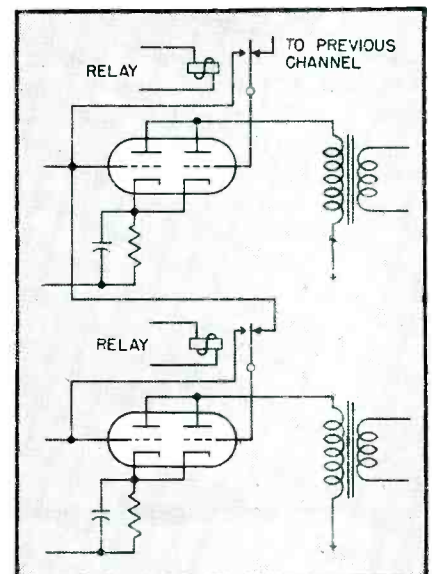

FIG. 7—Circuit for introducing overlap in the seismic record

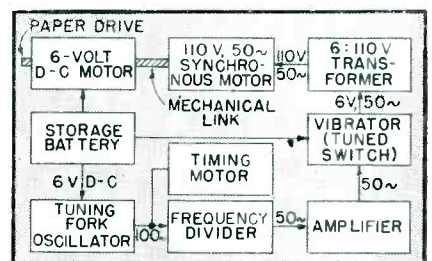

FIG. 8—Paper drive is held constant by the time-marker tuning fork

tact rectifiers such as copper-oxide and selenium rectifiers can also be used in a manner similar to vacuum-tube diodes.

One of the big advantages of the diode system is the fact that the avc voltage is applied to the diodes in a balanced bridge connection. If the bridge is well balanced, any residual low-frequency component in the avc bias voltage will not appear between the output terminals of the bridge which connect to grid and ground of the following stage. This means that less filtering is required after the avc rectifier in the diode control system. Therefore, it is possible to obtain greater speed of avc action for a given amplitude control ratio with the diode system than with variable-gain pentodes. In any system, the closer the degree of amplitude control, the greater must be the gain in the avc loop and the more the filtering required to maintain stability. Increasing the filtering reduces the rate of control.

Methods of Applying Avc

Another method which is used in connection with diode resistors involves a radio-frequency link. A radio-frequency oscillator drives an amplifier which is modulated by the rectified filtered avc voltage. The variable amount of radio frequency which is controlled by the signal output of the main amplifier is then applied to the diodes so as to change their effective resistance. This operation can be seen in the block diagram of Fig. 6.

Still another method which is in present use in seismic recording dispenses entirely with thermionic elements in the controlled stages. Tiny lamps are used in a balanced-bridge arrangement to control the amount of signal passed through the amplifier. The variation of control is obtained by applying current at radio frequency (or any frequency very high compared with the seismic frequencies) to the tiny resistance elements. The amount of high frequency current which is applied is controlled by the rectified and filtered seismic frequencies near the output of the amplifier.

There is considerable variation in methods of overall control of a large number of channels. Some companies prefer individual avc complete in each amplifier channel. Others use a single master avc amplifier which receives its input signal from the combined outputs of several channels and supplies a form of average control bias equally to all channels. Another method is to pair adjacent channels and have a common avc amplifier controlled by the outputs of both channels produce a common control bias for both channels.

There are many combinations of simplified control. They have the advantage of saving parts and therefore space, weight, and cost. The disadvantage is in the much closer matching of control tube characteristics and the necessity of changing tubes more often. Where each channel has its own independent avc system, much greater

variation in tube characteristics can be tolerated. Variations with use do not show up badly on the recording paper because there is partial compensation for gain variations when the avc control bias of an amplifier is a function only of its own signal output. Another disadvantage of master avc systems is in the wide initial variations in signal levels between different channels on certain types of long seismometer spreads.

Use of Filters

In all seismic amplifiers there must be a certain amount of tuning to discriminate against unwanted frequencies that mask the desired seismic frequencies. The desired band falls between 25 cps and 100 cps. This band is usually cut into smaller bands of interest according to the area in which the exploration occurs. Methods of filtering vary considerably between companies. Some use fixed band-pass filters of the conventional variety and some use combinations of high- and low-pass filters, with both upper and lower cutoff points adjustable by front panel control. Some use empirically shaped filters whose characteristics were determined from years of field experience in many shooting areas. These filters are unconventional in that the slopes above and below the center frequency may be widely different from each other.

It has been found highly advantageous in many areas to secure seismograms using different filters.

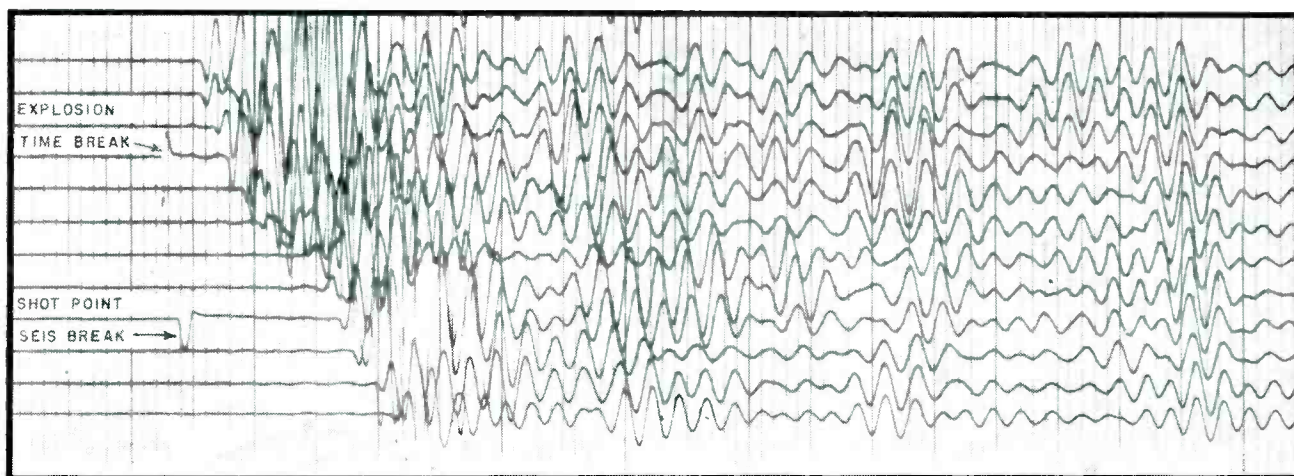

Portion of a seismogram, showing the time break of the explosion, the shot-point seismometer break, and the arrival of

nels. In the final overall test the galvanometer camera is used for a simultaneous check on all channels.

Seismic Recording Practice

A commonly used procedure in seismic recording is to add a part of the voltage from one seismometer group to the next adjacent group in a specified direction of the spread. This process is referred to as overlap or compounding, and is used for the purpose of improving the record by accentuating the appearance of the reflected waves against the random noise background.

A commonly used method of electronic overlap is shown in Fig. 7. When the relay contacts are in the right-hand position, each channel except the first one in a group receives some signal from the immediately preceding one, but from no other channel. This is mixed in the common plate circuit with the original signal of the channel itself. When overlap is not desired, the relay contacts are moved to the left and the two sections of the twin triode are in parallel for a single signal source and independent channel operation.

One of the most important elements in a seismic recording truck is the timing system. Without an accurate reliable timing system the records would be useless regardless of their purely seismic quality. All computations of subsurface depths depend on accurate timing. The heart of the timing system is a temperature-compensated tuning fork. It is common practice to use a 100-cycle fork driven by a vacuum tube system. A synchronous timing motor driven by the 100-cycle voltage from the fork oscillator has a disk mounted on it which has slots cut radially. These slots are spaced so that they permit light from a timing lamp to strike the sensitized paper across its full width in a narrow beam every hundredth of a second. One slot out of ten is wider so that a darker line is placed on the paper every tenth of a second. This darker line makes it much easier for the record computer to add the total time from the beginning of the record to a reflecting point.

In addition to knowing the exact time interval between any two timing lines it is also necessary to

maintain the recording paper speed constant so that a given time interval on one record will cover the same length of paper as on any other record. This consistency is essential if any comparison is to be made between records. There are several methods of accomplishing this result. Only one method will be described here because of its electronic interest. It is used chiefly where 100-cycle tuning forks are the standard for timing. Lower-frequency forks can be used but they are bulky.

The electric motor which drives the paper is usually a 6-volt d-c motor because the primary source of power in field recording trucks is a storage battery. In order to run this motor at constant speed a unique method has been developed whereby the speed is electronically controlled by the 100-cycle tuning fork. The d-c motor receives its power as usual from a 6-volt storage battery, but it is mechanically coupled to a small 110-volt, 50-cycle synchronous motor. This a-c motor maintains the d-c motor at the proper synchronous speed although most of the driving power for the d-c motor comes from the storage battery. The additional power necessary to hold the d-c motor to the proper speed is supplied by the 50-cycle synchronous motor.

In a typical installation a 1/100 horsepower synchronous motor controls a 1/30 horsepower d-c motor. The precise 50-cycle power for the synchronous motor is obtained from the 100-cycle tuning fork through an electronic frequency divider which drives a power amplifier. In order to eliminate large power tubes in this amplifier and their heavy drain on storage batteries, the power level is amplified only to the point where it will drive the coil in a tuned mechanical vibrator. This vibrator then supplies the storage battery power in accurate 50-cycle pulses which are stepped up by a transformer and smoothed by a filter before reaching the synchronous motor, as shown by block diagram in Fig. 8.

Communication Circuits

It is important that continuous communication be maintained between the recording truck and the

shooting truck. Where the distance between trucks on a spread is less than 2,000 feet it is convenient to use telephone lines. For greater distance, radio communication is used. In addition to voice transmission, provision must also be made for transmission of the time break (instant of explosion) and shot point seismometer first break. The latter gives the time of transmission through the earth from the position of the explosive in the hole to the top of the hole. Figure 9 shows a typical two-way wire telephone system and includes the shot point seismometer and blaster time break amplifier and cutout circuit. It is necessary to cut out automatically all stray signals from the shot point as soon as the time break and shot point seismometer break have been received because these signals are recorded through some of the same galvanometer elements that are being used for seismometer groups on the spread.

In radio transmission where amplitude modulation is used, it is often difficult to pick the exact starting point of the explosion time break because of static and other random noises in the receiver when the signals are weak. The explosion time break is a high-frequency pulse very similar to static. To get around this difficulty, one method used is to modulate the transmitter just prior to the shot with a constant 1,000-cps tone which is cut out at the instant of the explosion. The carrier is left on an additional length of time in order that the shot point seismometer break can also be recorded. In some cases it is not necessary to record the shot point seismometer break, so the explosion time break can be used to cut off the carrier and this event recorded at the receiving point is used as the time break.

Still another method is to start a 1,000-cps modulation on the carrier by means of the explosion and stop the modulation by means of the shot point seismometer pulse arrival. This system is shown in detail in the diagram of Fig. 10 which gives the wiring at the shooting truck. In the bottom center block the left-hand thyatron (type 2050) is fired by the explosion and operates the left-hand relay to connect the 6C8G

oscillator at the lower right to the triode amplifier in its own envelope. This amplifier feeds the modulator in the transmitter shown in the upper right block. Shortly after the 1000-cps modulation has started, the shot point seismometer voltage amplified by the 6C8G in the lower left fires the right-hand 2050 thyratron. The relay in the thyratron plate circuit grounds the oscillator output.

At the receiving truck the 1000-cps wave train may be recorded in its original form or only the envelope may be recorded. The initiation of the wave train, or leading edge of its envelope, gives the time of the explosion and the trailing edge gives the shot point seismometer arrival time.

In the lower left-hand block is shown a circuit which checks the times as transmitted by radio against the original pulses directly

from their source. This record is used only as a check against any possible defects which may arise in process of continued operation. The thyratrons drive the relays so hard that the relay delay is too small to be significant. An ingenious method of transmitting the two timing pulses by means of frequency modulation while reserving amplitude modulation for voice communication is described by Shook, Olson and Kerr in *Proc. I.R.E.* for October, 1944.

Complete Recording Units

The operator's panel is built in a single rack. At the top left is the control panel where all seismometer cables enter, and the signals from the various groups are distributed to the proper amplifier channels. This panel also includes means for testing breaks or shorts to ground in cables or seismometers. At the

top center is located the fork oscillator system and telephone amplifier beneath it. On the right is the galvanometer type recording oscillograph, usually referred to as the camera. In the bottom half of the rack there are twenty-four amplifier channels. Each chassis contains two channels. At the left of the channel array are the master switches which enable the operator to select rapidly any desired amplifier characteristics before shooting. Each pair of switches controls its corresponding row of channels. On the right-hand side of the amplifiers are the battery test panels and master firing controls.

This complete system is placed in a truck for use in rough country. These trucks are designed to operate in wooded or swampy sections where they often make their own roads and are able to knock down small trees.

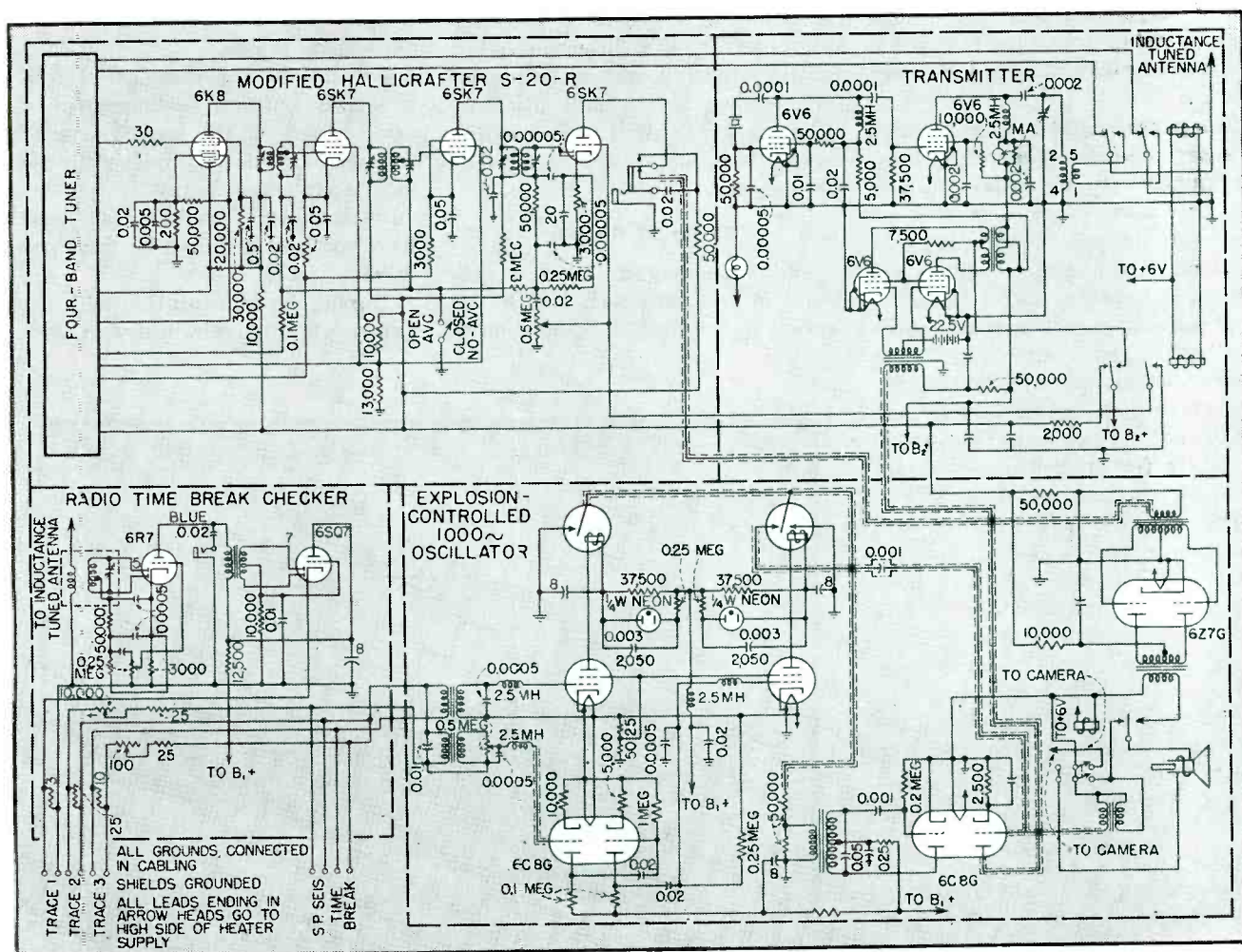

FIG. 10—Communication equipment and keying circuit are used to modulate a carrier from the time the shot is fired until the percussion wave reaches the ground surface above the firing point

VOLUME

By **ROBERT W. EHRLICH**

Maplewood, N. J.

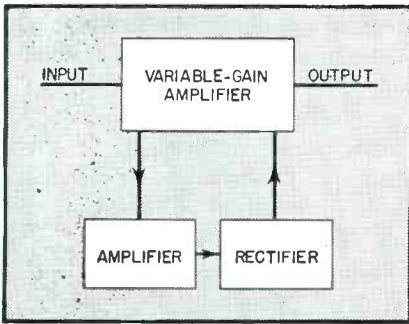

FIG. 1—Block diagram of an electronic volume-expander circuit in which the rectified signal is used to control gain

MANY people, having listened to volume-expansion amplifiers, have found them to introduce undesirable wows, gasps, pops, or just plain distortion in the reproduced output. There is, however, ample justification for volume expansion in the fact that a certain amount of volume compression is used in making a majority of recordings and sometimes in broadcast work. In addition, the reduction of amplification at low levels helps to reduce record scratch and background noise during such passages.

This paper represents the results of a series of experiments to find the answers to expander design. The expander to be discussed is the electronic type, wherein the signal is rectified and the resulting d-c voltage is used to control the gain of a variable-gain stage as shown in Fig. 1. There are many other ingenious ways of introducing volume expansion, but it is felt that this type provides the necessary flexibility for application to varied types of program material.

The expander illustrated in Fig. 2 was developed in connection with these experiments. It has been found to give satisfactory results with a wide range of program material, and, even when improperly adjusted, it does not have many of the undesirable characteristics experienced with other circuits. The complete circuit of the expander is shown in Fig. 3.

Requirements

The design of an electronic volume expander involves a number of interesting problems beyond those ordinarily encountered in amplifier work. The variable-gain stage must

operate at not just one point on its characteristic, but rather over the complete range of its characteristics without introducing distortion. The amplifier which feeds the rectifier circuit must have means for adjusting its gain without any audible indication, and this gain must be variable to suit the various input signal levels.

Finally, the rectifier must be capable of rectifying a complex a-c signal without introducing objectionable ripple into the signal circuit. Moreover, the time constants throughout the expander circuit must be so adjusted that full expansion can be obtained in something like 5 to 15 milliseconds, while the time taken to return to normal gain is about one second. By careful attention to all of these requirements, satisfactory operation can be obtained.

Choice of Circuits

The variable-gain stage is the heart of the expander, and its selection is the first consideration in

design. Perhaps the most widely used tube for this purpose is the 6L7, in which the d-c bias voltage on grid number 3 controls the gain of the tube with respect to grid number 1. Another popular method is to use a variable- μ tube such as the 6SK7 and let the d-c bias on the signal grid control the gain.

A less common but very ingenious circuit uses a triode tube as one leg of a voltage divider for the signal. The other leg is a fixed resistor. By varying the bias on the triode, the tube assumes different values of plate resistance, and thus there is a variation of the relative signal voltage which is taken off across the triode.

Because of the complex biasing problems on multi-element tubes, and because of the wide range of tube characteristics involved in the expansion stage, many of the circuit constants for that stage will have to be determined by trial and error.

During experimentation with the expansion stage, circuits were con-

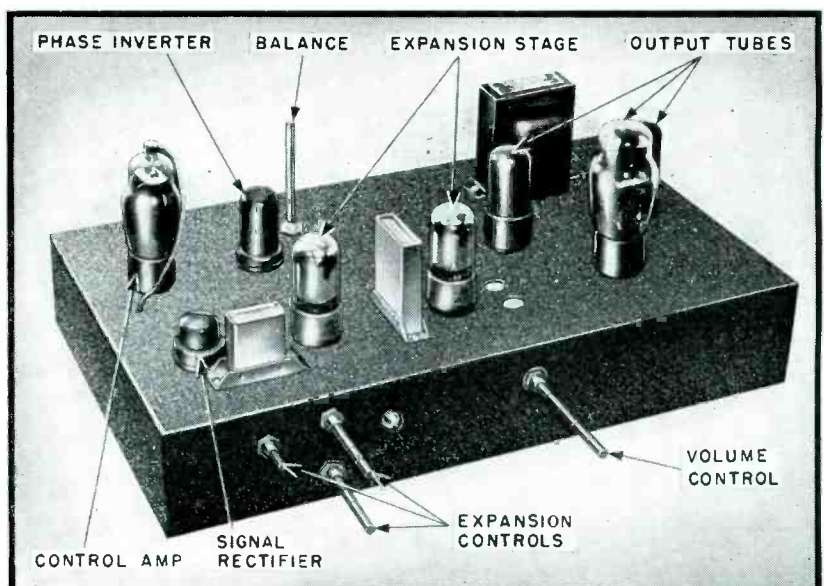

FIG. 2—Chassis of the experimental expansion amplifier

EXPANDER DESIGN

An electronic volume expander provides full expansion of a wide range of program material in about ten milliseconds and return to normal gain in one second. The problems encountered, methods of solution, and results of experimental work are included

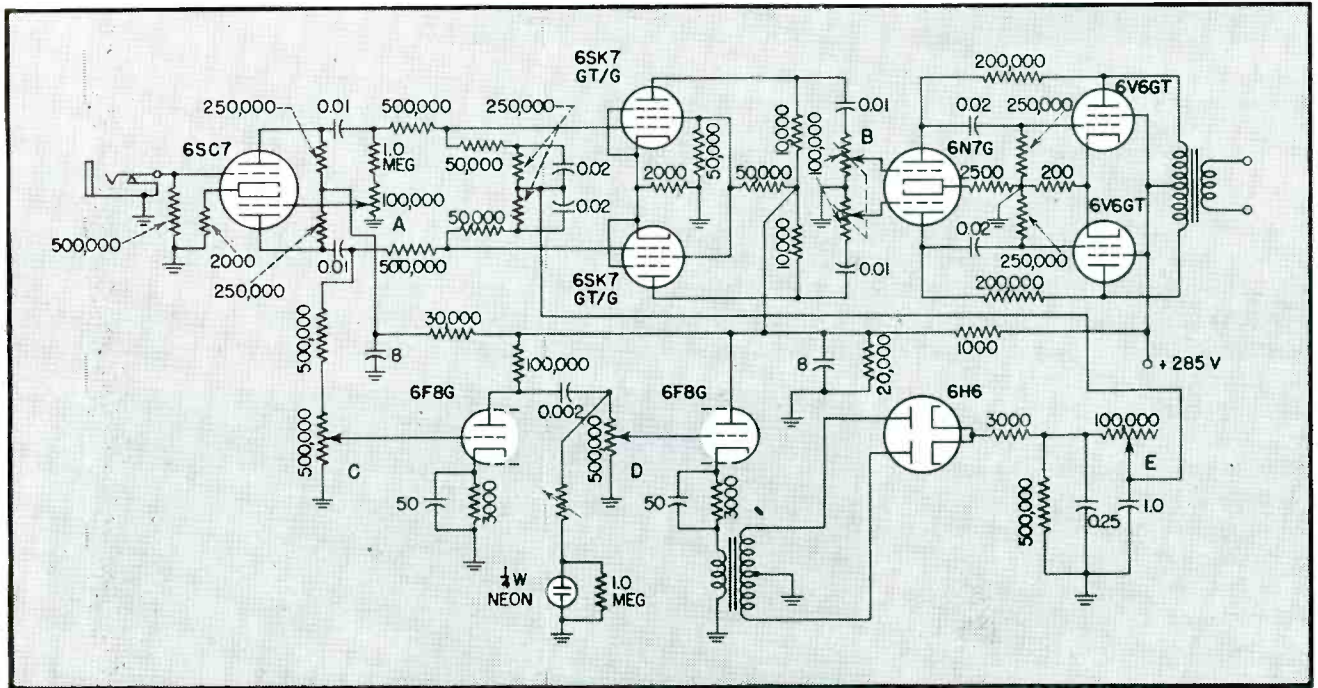

FIG. 3—Final circuit of the expansion amplifier. The lettered controls are identified as follows: A—balance; B—volume; C—input level; D—expansion; E—time constant

sidered where the input to the control circuit is taken from the output of the expanding stage rather than the input. This type of circuit would have the advantage of reducing the amplification necessary to drive the control circuit. It was found to be unsatisfactory, however, because of dynamic instability caused by the regenerative action. Any delay in expansion was greatly accentuated. Moreover, since the control voltage was proportional to the square of the signal input, the curve of gain vs signal was very steep at higher levels. With one circuit tried, the action of the expander was delayed by one or two seconds, after which the expansion would take place very suddenly. The result was that the gain had no relation to signal strength with a typically variable input signal.

The push-pull circuit for the expander of Fig. 3 was selected after several disappointing experiments

with single-ended circuits. Not only do the latter have a tendency to distort due to curvature of the tube characteristic, but they also are affected by any residual ripple that may come through from the rectifier. These effects are largely cancelled out in a push-pull stage.

Advantages of Push-pull

Another advantage, though not apparent at first, is the possibility of avoiding the use of bypass capacitors. Changes of screen and cathode voltages in an expanding stage are in such a direction as to oppose the change in gain caused by a change in grid bias. If the cathode or screen voltage variation is retarded by a large bypass capacitor, it is possible for the gain of the stage to increase before this capacitor can change its charge. When it does charge, it pulls the gain down. The result is that the

amplifier gain overshoots its final mark and there is a tendency for thumps to be heard in the output. Figure 4 is an oscillogram which illustrates this type of transient response.

Effect of Transients

Another difficulty inherent in single-ended circuits is the possibility of introducing low-frequency transients or thumps in the output, due to rapid expander action. Such transients are cancelled out in a push-pull stage, since the control bias is applied to both grids simultaneously. Even with push-pull operation, however, it is still necessary to keep the transients in the output of the individual expander tubes from becoming so large as to cut off the following stage. This can be accomplished by transformer coupling, a special phase-inverter tube¹, or, as in Fig. 3, through the use of

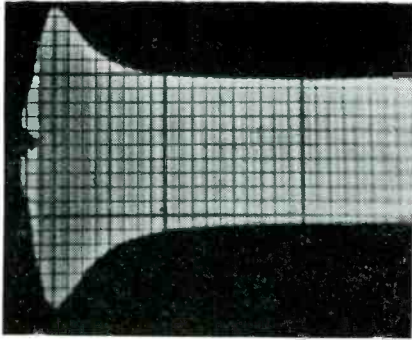

FIG. 4—This oscillogram shows the overshooting of gain caused by a 10- μ f cathode bypass capacitor connected across a 10,000-ohm cathode resistor

low values of plate load resistance and low values of coupling capacitors. The loss in low-frequency response is compensated for by the RC networks in the grid circuits.

In the control amplifier circuit of Fig. 3, there are two gain controls. One is used to vary the amount of expansion, and the other compensates for major differences in input signal level. A more common means of controlling expansion is the use of a potentiometer in the rectifier circuit, but this was found unsatisfactory because of its effects on the time constants in the rectifier.

Rectifier Problems

The rectifier with its associated filter is perhaps the most important section of the amplifier, for it is here that the dynamic nature of the entire unit is determined. Improper consideration of these factors can lead to serious volume distortion. The problem is to get an RC filter circuit which will react very rapidly to impulses of signal, and still eliminate all traces of rectifier ripple from the signal circuit. The solution is to make all resistors through which the capacitors charge very small, and those through which they discharge very large.

Figure 5 shows the type of rectifier circuit to be considered, along with its equivalent circuit. The charging time is determined principally by the internal impedance of the driving amplifier, r_p , the plate resistance of the diode, r_d , and R_1 ; along with capacitors C_1 and C_2 . The discharge time is

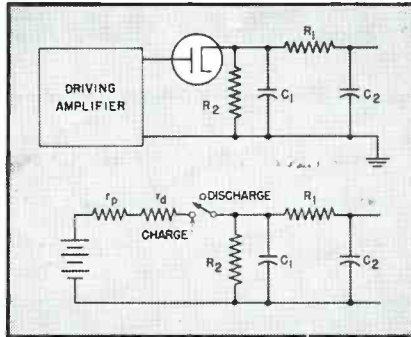

FIG. 5—A simple rectifier and filter circuit is shown at the top. Its equivalent circuit shows the factors that determine the charging and discharging time

determined by resistors R_1 and R_2 and capacitors C_1 and C_2 . It is important also to remember that any other capacitors associated with the expander circuit can

resistance between the controlled grid and ground should, if possible, be kept below the maximum value specified for the tube used. The use of a cathode-follower circuit in the driving amplifier circuit of Fig. 3 makes the driver impedance very low and makes it easy to obtain a low charging time. Control of the time constant is obtained by making resistor R_1 in Fig. 5 variable.

Figure 6 shows an oscillographic determination of the minimum charging time for the expander of Fig. 3. A 500-cycle signal was keyed into the circuit with expansion full on, the 3000-ohm series resistor shorted, and the time-constant control set at its minimum value.

The number of cycles required for 64-percent expansion indicates

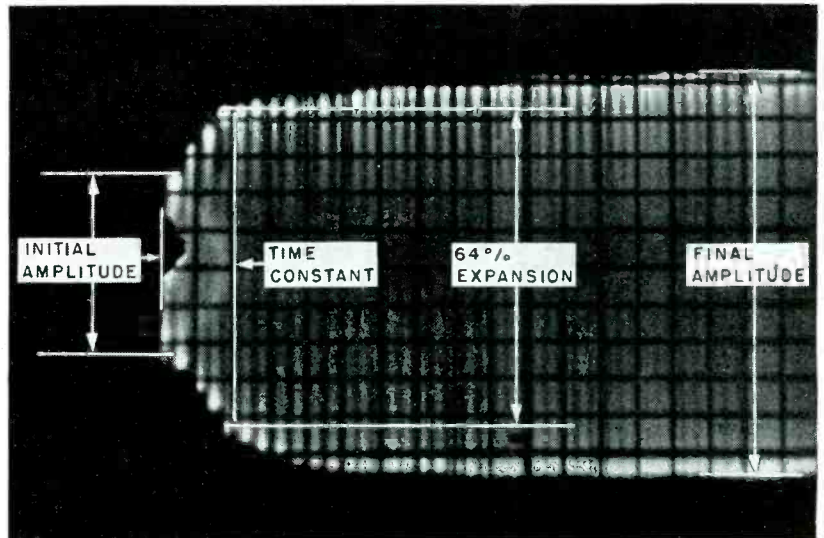

FIG. 6—Oscillogram showing the shortest possible transient response for the circuit of Fig. 3. The notch at the left was caused by masking tape over the stationary spot on the screen

affect the time constants.

Calculation of the exact time constants of a circuit such as that of Fig. 5 is rather complex, but the following simple formulas developed by E. W. Kellogg and W. D. Phelps² will give the necessary values closely enough.

$$\text{Charging time constant} = (r_p + r_d) C_1 + (r_p + r_d + R_1) C_2$$

$$\text{Discharge time constant} = R_2 C_1 + (R_1 + R_2) C_2$$

Adjustment of values should be made so that the minimum charging-time constant will not be over 15 or 20 milliseconds and the discharge-time constant not less than 0.5 second. In addition, the total

charging-time constant, eight milliseconds in this case. In practice, the insertion of the 3000-ohm buffer resistor was found valuable in materially reducing rectifier ripple. This resistor brought the time constant up to 12 milliseconds.

Static Test

Performance is determined by testing for change in gain, or expansion, with respect to control voltage. For this test, control voltage is most easily obtained from a battery and potentiometer. A gain curve for the expander is shown in Fig. 7. The points to be noted are first, that the maximum

change in gain without distortion must be at least about three times (10 db), and second, that the curve of gain versus voltage should be fairly straight over the range selected.

To compensate theoretically for a typical compression characteristic, all of the expansion would have to take place in the upper two db (20 percent) of the control voltage swing. This characteristic is neither necessary nor desirable. For one thing, the input level to such a circuit would be very critical, necessitating many readjustments of input level. Furthermore, this type of curve can lead to undesirable dynamic characteristics, especially in connection with overlong time constants. This combination will make the expansion come on suddenly, many milliseconds after the initial input impulse. The effect is difficult to describe, but it is unquestionably unpleasant.

Operation

Setting of the amount of expansion and the time constant is complicated by the fact that it is practically impossible to detect the action of a properly adjusted expander. There is a natural tendency to advance the expansion control to the point where the effects of the expander can be heard, for if time and effort have been put into the construction of such a circuit, one likes to hear it work. As a matter of fact, the only way to tell accurately how well an expander is operating is to play the same passage twice, once with expansion on and once with it off. This is only possible with phonograph records, for which reason records are probably the best source of program material for one who is learning to use an expander.

Once some experience has been gained with the expander, the two gain controls *C* and *D*, and the neon indicator in Fig. 3 can be used to advantage in setting up the expander for operation with any type of signal. The resistors associated with the neon lamp are so adjusted that the lamp begins to glow when the signal voltage is large enough to drive the expander to full expansion. The level at this point is adjusted by control *C* in such a way

that the lamp will blink at peaks of modulation. For any radio station or record, this adjustment can usually be made in a few seconds, and it will hold as long as the same input source is maintained. With the signal level in the expansion control circuit so adjusted, it is then possible to set the second gain control, *D*, in terms of its own panel calibrations to give the number of decibels expansion desired for the particular program material.

Typical Control Settings

Actual settings of the expansion and time-constant controls will naturally vary for different types of program material. Symphonic selections are perhaps easiest to expand. This type of music will take all the expansion the amplifier can give, at the shortest time constant, without any unpleasant reaction. The only limit here is the point where soft passages are too soft to hear and loud ones uncomfortably loud. Martial band music also falls into this category.

Dance music is a little more difficult to handle, and expansion should be used cautiously. The time constant should be short when the music is slow; but if the music is fast and hot, a long time constant is required to swamp out the rapid volume impulses and prevent jerkiness.

Speech is also difficult to handle but expansion can still be used to advantage if it is used sparingly. Time constants on speech should be kept short to preserve the natural expression. An over-long time

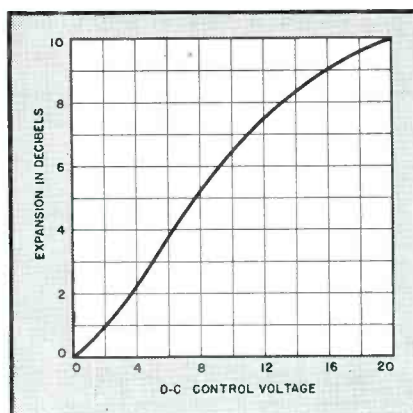

FIG. 7—Static gain versus control-voltage characteristic of the push-pull expansion stage shown in Fig. 3

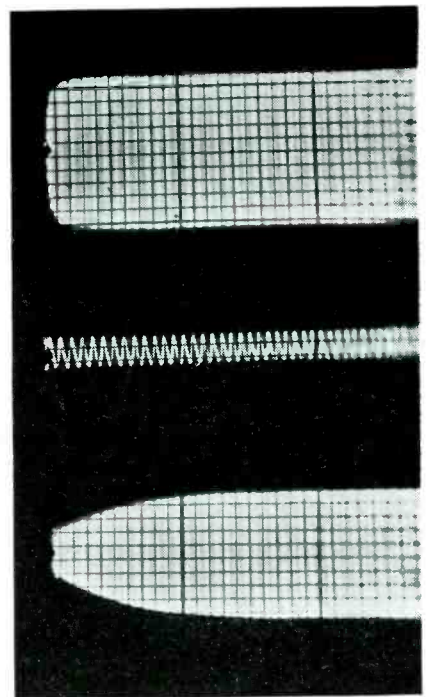

FIG. 8—Variation in charging-time constant available with the circuit of Fig. 3. Minimum is shown at the top of the illustration, and maximum at the bottom. In the center, a 60-cycle trace is given for reference

TABLE I. RECOMMENDED EXPANDER SETTINGS

Program Material	Expansion	Time Constant
Symphonic Music	Full	Short
Band Music		
Dance Music (slow)	Medium	Short
Organ Music	Low	Short
Speech	Low	Short
Dance Vocals		
Swing Music (fast)	Medium	Long
Operatic Vocal Solos	Not Recommended	
Instrumental Solos		

constant and excessive expansion can lead to a very undesirable gasping or breathless effect.

One type of material for which expansion is not recommended is a vocal or instrumental solo. The performer puts in his own volume expression, and expansion will seriously distort it. The effect is at its worst when the expansion control circuit has peaks in its frequency response so that certain notes are expanded out of proportion to the rest.

Table I indicates in convenient form the expander settings recommended for various types of material.

REFERENCES

- (1) Weidemann, Lt. Henry K., USNR, A Volume Expander for Audio Amplifiers, *QST*, p 19, Aug. 1945.
- (2) Kollogg, E. W., and Phelps, W. D., Time Delay in Resistance-Capacity Circuits, *ELECTRONICS*, p 22, Feb. 1937.

CRYSTAL-DRIVEN for D-C Amplifiers

A 1000-cycle signal actuates a rochelle-salt crystal that drives a carbon button in series with the d-c signal to be amplified. The composite signal is amplified and demodulated at high level

By JAMES A. WILLIAMS

Naval Ordnance Laboratory
Washington, D. C.

OF the many problems encountered in the design of a sensitive d-c amplifier, one of the most troublesome is that of drift of the zero-signal point due to unavoidable changes in supply voltages, circuit constants and tube characteristics. One solution is to impress the d-c signal on a high-frequency a-c signal in such a manner that the resultant amplitude of the combination signal is proportional to the instantaneous value of the incoming d-c signal. The modulated signal is then amplified and rectified at high level to obtain a d-c voltage or current proportional to the original d-c signal.

One method of applying this principle of operation involves the use of a mechanical chopper which periodically interrupts the d-c signal and applies the resulting a-c

signal to the input of a conventional a-c amplifier. The principal limitation of this method is that the highest frequency component of the signal to be amplified must be low compared to the chopper frequency. This is sometimes difficult to achieve because of the upper frequency limit of the vibrating or rotating mechanical system due to mass, stiffness and other factors. Moreover, considerable hash is caused by the making and breaking of the contacts and this limits the lower range of signals to be amplified.

Construction of Driver

The device to be described is in effect a chopper which is less subject to the above mentioned limitations than the conventional discontinuous mechanical device. It consists of a carbon microphone

button mechanically coupled to a rochelle-salt crystal. The method of coupling and mechanical details are shown in Fig. 1. The crystal unit is supplied excitation by an oscillator operating at a frequency of 1000 cycles. It is essential that the output of the oscillator remain constant. This condition is obtained by the use of a three-watt tungsten lamp in the cathode of the first stage of the oscillator unit.

The d-c signal to be amplified is applied to the input transformer through the carbon button as shown in Fig. 2. Conversion of the d-c input to an a-c signal is accomplished by the carbon button due to the continuous vibration of the rochelle-salt crystal to which the button is mechanically coupled. This action results in a loss in signal of about 3 to 1 between the d-c input and the primary of the input transformer. A step-up ratio in the transformer of about 30 to 1 compensates for this loss and results in an overall gain of approximately 10 to 1 between the d-c input terminals and the grid of the first tube.

Calibration

To permit accurate measurement of the d-c signal, means is provided for calibration of the system by the introduction of an accurately known calibrating potential.

As shown in Fig. 3, the calibration system consists of a ladder

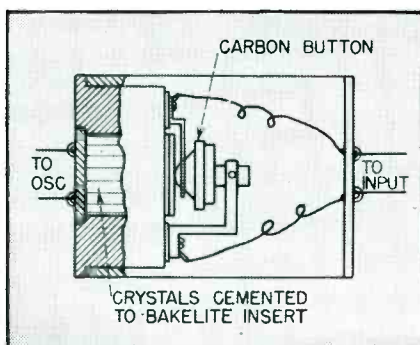

FIG. 1—Mechanical details of the crystal-driver assembly

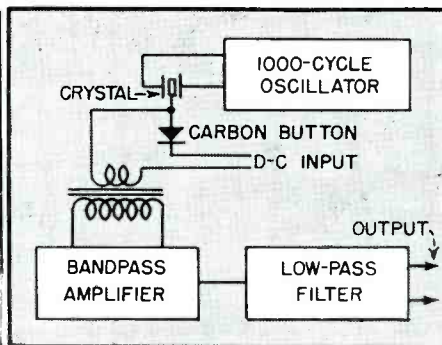

FIG. 2—The essential units of the system

MODULATOR

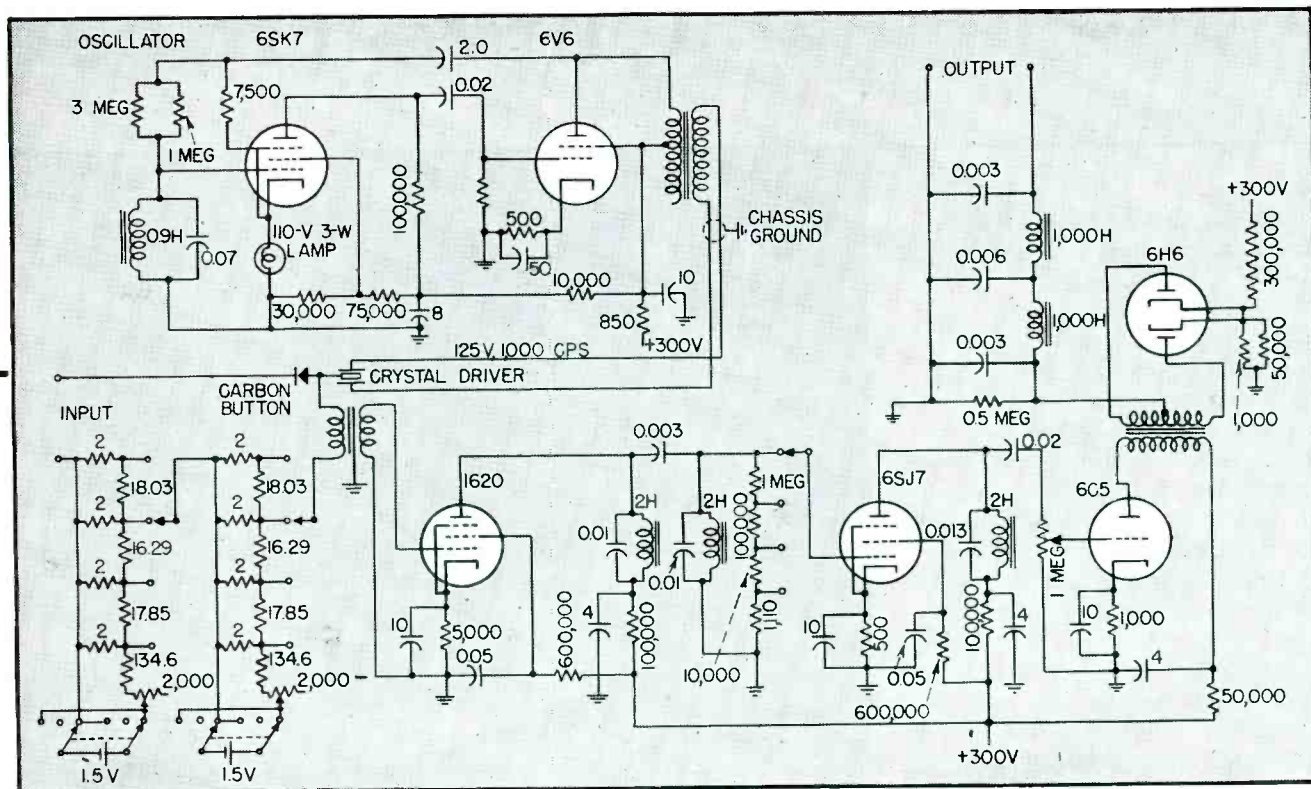

FIG. 3—The circuit shown above provides a d-c output of 40 volts with an input of 20 microvolts

network supplied by a 1.5-volt battery, with a switch for reversing the polarity. The calibrating voltage appears across a 2-ohm resistance in series with the input and is continuously adjustable over the entire range of the amplifier. A duplicate calibration system may be used as shown to balance out any steady d-c potential that may be present in the input.

The a-c signal resulting from the action of the converter is amplified by a three-stage bandpass amplifier. The response of the amplifier used is flat within ± 0.5 db from 900 to 1100 cycles, making possible observation or recording of signals from 0 to 100 cycles. This pass band might be extended if a higher frequency response were desired. The carrier signal is effectively eliminated by a low-pass filter having a cutoff frequency of 150 cycles, and an attenuation of 70 db at 1000 cycles. The output filter operates into a 500,000-ohm load.

The input impedance of the device is limited by the carbon button to around 75 ohms. This imped-

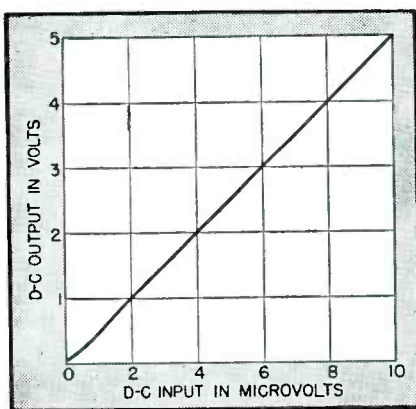

FIG. 4—The calibration voltage was used as the input signal to obtain this curve

ance might be increased by adding series resistance, with a consequent loss in voltage sensitivity. A gain control and step attenuator are included in the amplifier, to provide for a wide range of input levels.

Output Voltage

In Fig. 4 is shown a linearity curve of the over-all system. This curve was obtained by using the

calibration voltage as the input signal and reading the output voltage on a high-impedance d-c meter. The attenuator was turned to the maximum sensitivity position and the gain control adjusted to give 5 volts output with an input of 10 microvolts as read on the dial of the calibration system. The curve was repeated on each scale with results that deviated only about three percent. The maximum output voltage obtainable is 40 volts with an input of 20 microvolts. This makes it possible to calibrate the system at any convenient output voltage up to this value.

The instrument was used satisfactorily in making field measurements of signals ranging in level from 2 microvolts to 30 millivolts and varying in frequency from 0 to 100 cycles. No zero shift was observed.

For use on the high-sensitivity range, it was found necessary that the input tube and the crystal driver be properly cushioned to prevent microphonics and that adequate shielding be employed.

Curve-Tracer

By R. K. HELLMANN

Connecticut Telephone & Electric Div.
Great American Industries, Inc.
Meriden, Conn.

ACOUSTICAL DEVICES such as telephone handset receivers, loudspeakers, and microphones are now manufactured in accordance with performance specifications which call for a predetermined output-versus-frequency curve with comparatively narrow tolerance limits. In order to control production quality it is necessary to check the performance of each unit produced.

Among the various methods of recording a test curve the semi-permanent trace obtained with a cathode-ray tube of long screen persistence was found the most practical solution. A curve traced in this manner with a relatively slow sweep can be made visible between 3 and 15 seconds, which is long enough to produce the impression of the complete diagram, and short enough to cause no interference with a subsequent curve.

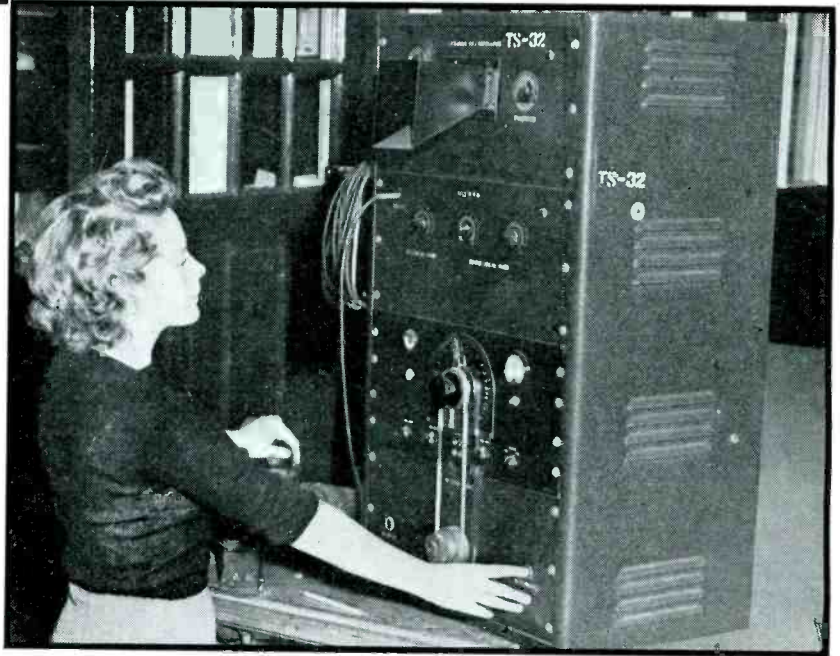

With her left hand the operator holds a handset receiver which is being production tested for frequency response. The belt, center, drives the bfo and synchronizes it with the c-r sweep. Trace appears at top, inside light shield

The curve tracer described here is based on this recording principle. A study of the literature reveals considerable previous work in this direction, largely with the view of producing diagrams automatically by means of advanced electronic arrangements, whereas in the present instrument straightforward circuits and methods are used. However, the fact that in its present form it has withstood the rough treatment on the assembly line over a period of five years while testing well over a million units justifies this report.

Operation of the curve tracer is shown in the block diagram in Fig. 1. The device under test is fed from a beat-frequency oscillator whose frequency is varied by a mechanical drive. The same drive also actuates a potentiometer which controls the horizontal deflection of the luminous spot in the cathode-ray tube. The device under test may be, for instance, a handset receiver.

It is coupled to an artificial ear. The output of the latter is amplified, rectified, and applied to the vertical deflection plates of the oscilloscope.

Frequency Sweep

The mechanical drive affords automatic scanning and consists of a reversible a-c motor with double gear reduction. On the slow shaft is a coupling device which, in the engaged position, connects the motor drive by means of a pretensioned metal belt with the pulley on the beat-frequency oscillator. Also on the slow shaft is a cam which operates two adjustable sets of contacts.

Figure 2 illustrates the operation of the drive circuit. When the starting button is pressed, the armature of the motor is energized through the contacts of the holding relay so the motor moves forward, starting the frequency sweep.

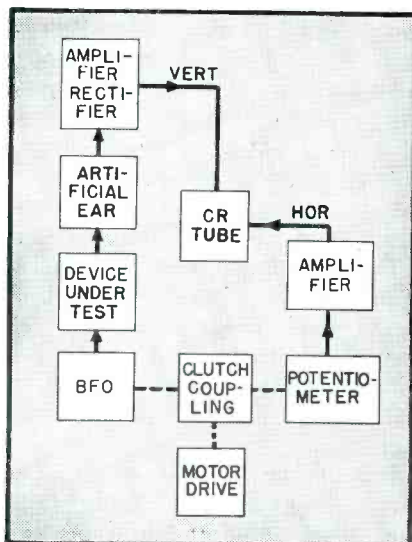

FIG. 1—Curve tracer includes these units. Artificial ear is a crystal or capacitor microphone

for ACOUSTIC DEVICES

Quality control over full-scale production output of handset receivers is obtained through the use of a powered-sweep bfo, a long persistence c-r tube, and suitable test fixtures

When the cam opens the adjustable-end contact, the holding relay releases and reverses the motor. This moves the beat-frequency oscillator toward its starting frequency.

Near the rest position, a cam-operated switch opens the armature circuit and stops the motor. If the inertia of the armature should carry the cam beyond the range of this rest position a second contact on the same adjustable arm closes and makes the motor rotate in a forward direction until it comes to rest between the two contacts.

When the end contact in the forward direction opens, a quick-acting relay lifts the bias of the cathode-ray tube. The bias is normally sufficiently negative to blank out the beam. In this manner a trace is produced on the screen only during the forward sweep. Since current density in the spot and accelerating voltage are high to make the afterglow of the trace last a long time, this precaution is necessary to prevent burning of the screen with a stationary spot.

Provisions are made to operate the drive and the frequency-determining potentiometer by hand so details of the diagram can be retraced. To this end the coupling device on the slow motor shaft can be pressed inward to disengage the metal belt from the shaft of the drive and the associated cam. However, engagement with the potentiometer which controls the horizontal beam displacement is retained. When released, an arrangement of spring pins relocates the oscillator control at the starting frequency as determined by the adjustable contact arm.

Since manual operation does not

energize the holding relay the cut-off bias must be lifted in that case by pressing a button marked 'Manual'.

Potentials at both ends of the sweep potentiometer can be adjusted by two separate controls so the frequency range of the sweep, as set by the adjustable cam contacts, can be spread out to any desired length on the screen.

Test Fixtures and Circuits

It will be realized that the curve tracer as a production testing device is only as practical as the auxiliary apparatus and fixtures.

Figure 3 shows the test fixture and circuit of a handset receiver. Since the cavities in the molded cap of the handset establish the shape of certain parts of the response curve, the test fixture consists of a handset with a special cap that is quickly detachable by means of a bayonet lock. A spring holds the unit against the coupler of the artificial ear with the prescribed pressure of 1 kilogram and also holds

it safely in the loading position. The receiver under test is connected to the low-impedance output of the beat-frequency oscillator through a resistance equal to the nominal receiver impedance at 1000 cycles, and the voltage is adjusted at the same frequency so 1 mw is delivered to the receiver.

A crystal microphone made by Ballantine Laboratories and equipped with a coupler of approximately 12 cu cm has been found highly suitable for this application.

In order to stabilize the receivers magnetically a cam transfers the receiver leads momentarily to the source of stabilizing current during the closing of the handset arm in the fixture and restores them to the audio voltage just before the receiver seats itself on the coupler.

A somewhat more elaborate fixture is illustrated in Fig. 4. It accommodates the two receivers of a headset and is therefore equipped with two artificial ears. These are mounted on a support plate which can be lowered by a foot lever for

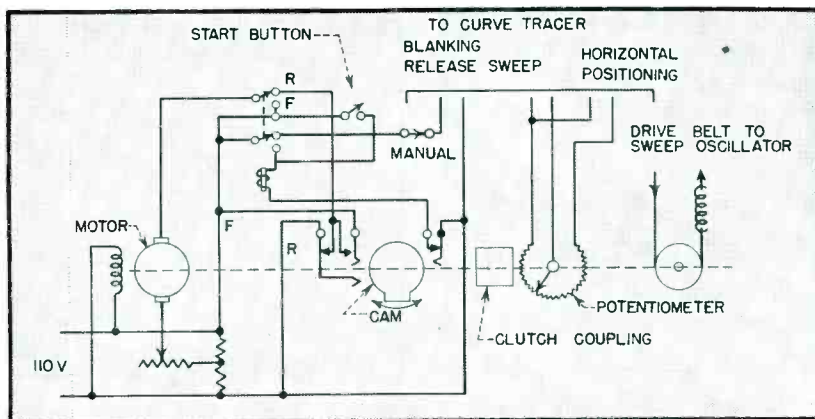

FIG. 2—Details of drive circuit. Cam and contact arrangement establishes start and stop positioning of mechanical train

loading. The receivers are placed in positioning recesses in the loading platform. When the pedal is released the ears are lifted by a spring which presses their couplers against the receiver units and the individual loading weights.

When used for testing high-impedance headsets of the resonant type, this fixture is associated with the circuit shown in Fig. 5. This was developed in accordance with the observation that sufficiently informative curve-tracer diagrams are obtained if both receivers, coupled to their respective ear cavities and connected in series, are run together. The output of each ear can be connected to the curve tracer by means of switch T.

The data to be checked are the frequency and amplitude of the resonance peak, its width at 6 db down, and the impedance at peak output. Measuring the latter is at the same time an insurance that the output measurement in series connection does not introduce errors due to uneven voltage distribution. The test circuit can accordingly be arranged to provide four conditions which are selected by means of a 3-deck, 4-position switch, S.

After placing the headset in the fixture the operator proceeds as follows: position 1 of the main switch S is a calibrating position. Voltage E_1 is adjusted at 1000 cycles to a standardized value, and a fixed small fraction is fed directly into the curve tracer input whose gain is then adjusted against a calibrating mark on the screen.

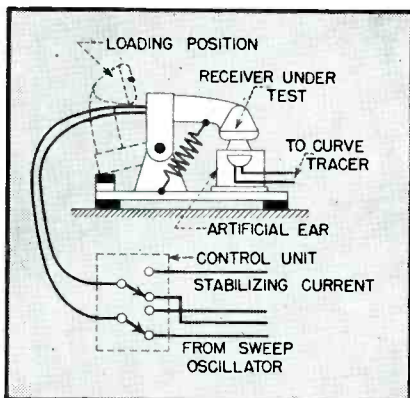

FIG. 3—Production test fixture duplicates physical arrangement of actual handset receiver

In position 2, one-half of the standardized input is fed to the two receivers in series and the resonance peak is noted. Immediately, the curve is repeated with full input voltage in position 3. The location and magnitude of the main resonance can be noted as well as its width at a level 6 db below the peak, which will still be visible faintly from the trace taken in position 2.

By switching S to position 4 a comparatively small measuring resistance R is inserted into the circuit and the potential drop across it connected into the curve-tracer input. The resulting curve represents $E_1 R/Z$ and can, as R and E_1 are constant, be interpreted in terms of Z as a function of frequency. It is particularly convenient to read impedance at the output peak frequency, which has been set as a specification requirement.

When it comes to testing high-fidelity receiver units whose output level must be kept within narrow limits and is to be determined in terms of absolute sound pressure, the crystal microphone is no longer used.

Figure 6 shows a production line fixture using a Western Electric 640-A capacitor transmitter with a 6-cu-cm coupler, preamplifier and power supply.

The fixture is combined with a demagnetizer which reduces the initially fully-charged receiver magnet to a value indicated by the curve-tracer diagram.

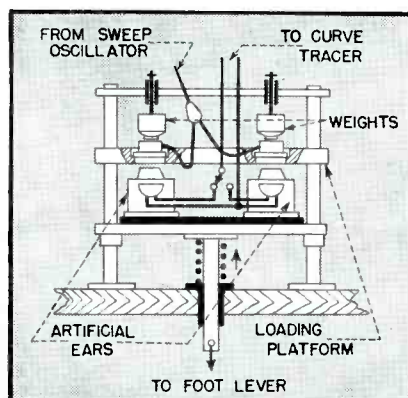

FIG. 4—Duplex fixture tests two receivers of a headset at once. Circuit is shown in Fig. 5

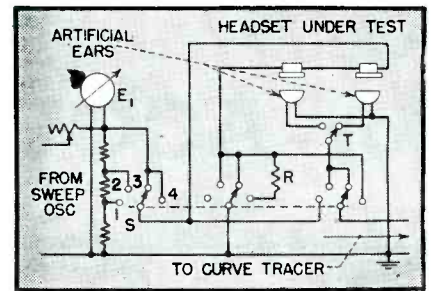

FIG. 5—Headset receivers are tested in series using the production fixture of Fig. 4. Individual outputs are connected to the curve tracer by switch T

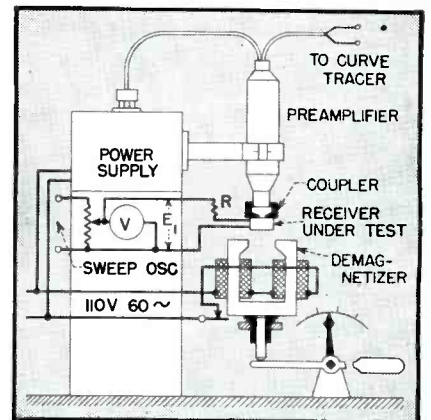

FIG. 6—High-fidelity receiver units with narrow limits are tested in this fixture which combines a capacitor microphone and hand-actuated demagnetizer

The U-shaped laminated yoke of the demagnetizer is excited with 60-cycle a-c and can be lifted by means of a hand lever to expose the receiver magnet to a stronger or weaker alternating field. In the lowest position the exciting winding is disconnected.

For use with this fixture the standard curve tracer was modified slightly. The bias of the cathode-ray tube was adjusted so that a faint spot was normally visible instead of completely cut-off. The clutch mechanism was provided with a detent at the 1000-cycle point in the disengaged (manual) condition.

With this arrangement the first test operation is to set the sweep frequency by hand to 1000 cycles and adjust the input voltage E_1 , so that the light pointer hits the zero-db level marked on the screen (see also Fig. 7B). The calibrated voltmeter will then indicate, in db above a reference level, the sound

pressure developed by the receiver under test. By gradual demagnetization, response can be brought between limits marked on the voltmeter dial.

The clutch is subsequently re-engaged to the lower starting frequency and the sweep with a brilliant trace is initiated by pressing the starting button. The curve will, of course, go through zero at 1000 cycles and therefore represent deviation from that point.

Screen Markings

To facilitate rapid interpretation of the diagrams produced by the curve tracer, the screen markings deserve special attention. Figure 7 illustrates three types of markings used.

Lines and symbols are usually drawn directly on the outside of the screen. The choice of a particular marking scheme depends, of course, largely on the test specifications. In Fig. 7A for example, which shows the pattern obtained with the fixture of Fig. 3, it was possible to describe the tolerances of the output curve simply by an upper and lower limit. The shaded areas were painted red so parts of the ordinarily bluish-green trace changed to that color as soon as they exceeded the permissible limits. It would be conceivable to utilize this for an automatic rejection feature by placing in front of the screen a phototube which has been made selectively responsive to red by suitable filters.

The two dashed frequency lines serve as calibration points for frequency adjustment, and the horizontal markings serve for gain adjustment by means of a standard unit.

In Fig. 7B, the curve will always go through the intersection of the 1000-cycle line and a zero-db horizontal. Again a number of calibration markers can be seen. Due to higher accuracy required with this test, the width of the trace had to be considered. Unless push-pull deflection amplifiers are used, the diameter of the luminous spot is likely to vary from one end of the curve to the other. If this is the case, the lines denoting the limits

should be corrected so that the interference between any part of the spot and the limit line is not acceptable. To use for this purpose the imaginary center of the spot was generally found unsatisfactory in practice.

In Fig. 7C still another method of marking is indicated. A number of taut black wires are placed across the screen to denote such values as minimum amplitude and frequency limits. This method is particularly convenient for small production runs.

Interpretation

Referring to Fig. 7, a few typical clues to production faults as indicated by the curve tracer can be seen. In the high-fidelity receivers, Fig. 7A and 7B, the slight hump at about 2000 cycles is controlled by an acoustical coupling resistance which connects two cavities inside the receiver.

If this resistance is produced by a piece of silk, its porosity must be kept in a prescribed relation to the volume of these cavities to produce a flat response curve. Too little porosity will result in a pronounced peak in the curve, too much, in a dip. If the silk breather has come loose, this is usually revealed by a rake near the top of the hump.

The peak near the high frequency end is caused by acoustical cavities between the diaphragm and the earpiece of the receiver. In this space a moisture guard in the form of a thin diaphragm is usually placed. Slackness of this membrane may modify the shape of this peak considerably and it is therefore important to control its tension carefully. The shape of output curve in this region reveals to the skilled operator the nature of the required correction.

In the response curve shown in Fig. 7C the location and height of the resonance peak is influenced largely by the condition of the magnetic diaphragm. One of the common faults indicated by a shift in the resonance peak is distortion of the seating surface caused by insufficient lapping or faulty clamping. The degree of sag due to magnetic attraction determines the effective

air gap of the receiver and is therefore revealed in both the output and impedance curves. Likewise the degree of magnetization can be determined.

Obviously there are many problems in quality control of acoustical devices where testing by the curve tracer can be applied advantageously. These include production testing of loudspeakers and radio receivers. For testing the latter, the sweep frequency generator can be used to modulate the signal generator, and the demodulated signal as picked off the voice coil of the receiver under test could be used for vertical deflection. Such a test would take only a few seconds but might present a better picture of the audio performance of a receiver than methods presently used.

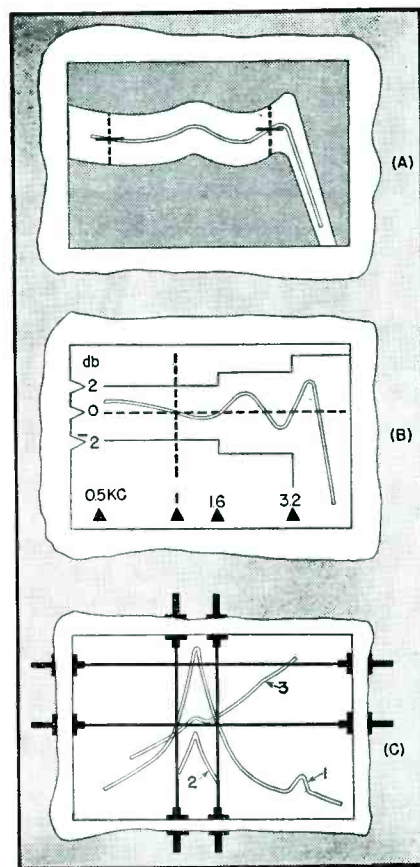
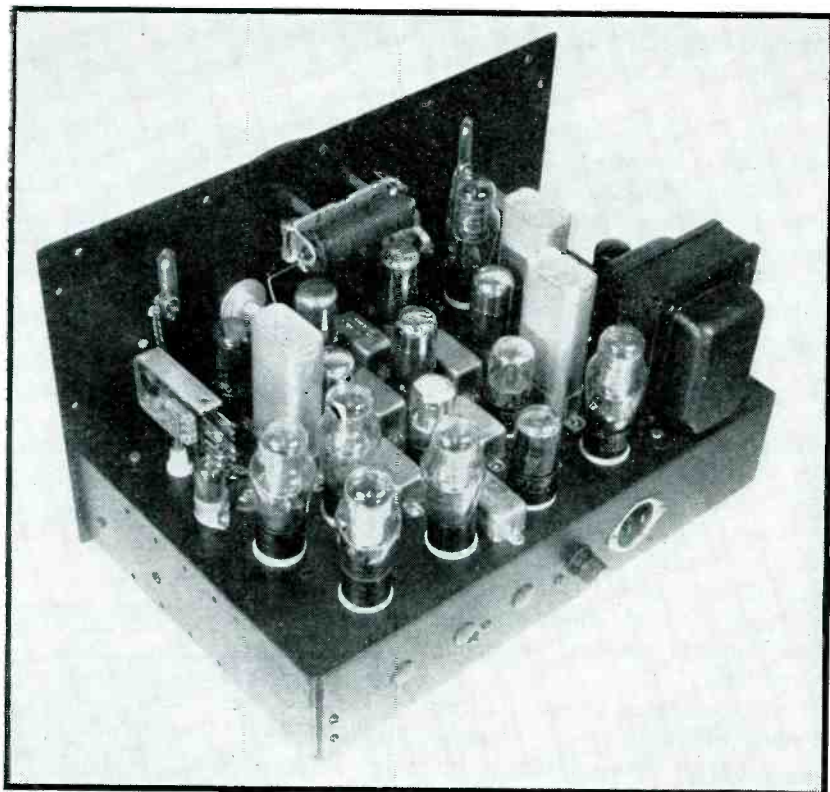

FIG. 7—Three alternative types of screen markings for production-line evaluation of curve-tracer readings. Pattern at A has shaded area painted red to show plainly any deviation of the trace from established limits. Marking B has limit lines established for contact with peaks in curve. Taut black limit wires are used at C for ease of changing on short runs

Machine Gun

By ARVID D. PETERSON

*Radio Engineer
Naval Air Station
San Diego, California*



Rear view of indicator, designed for operation from 115-volt, 60-cps power. Overload relay operates if gun stops before firing the full 17 rounds required to shut off the timer

testing operations require a large number of measurements to be made rapidly. The instrument is of radically new design, is direct-reading from 600 to 900 rounds per minute, and operates from the 60-cycle a-c line.

Circuit Principles

The instrument consists essentially of an electronic counter, timer, gate circuit, vacuum-tube voltmeter, calibrator, and voltage-regulated power supply, arranged according to the block diagram in Fig. 1.

The mechanical switch unit is clamped to the top cover, directly over the belt-feed slide assembly of a .50 calibre machine gun. The reciprocating action of the slide mechanism actuates a Micro-Switch to initiate generation of a saw-tooth voltage pulse each time a round of ammunition is fired. Firing of the gun thus generates a series of periodic saw-tooth wave forms. These are differentiated

THE testing and qualifying of machine guns requires checking as to rate of fire. Since these measurements must be made from a single burst which lasts but a second or two, ordinary methods of measurement are not adaptable.

One system used in practice employs a cycle recorder as a means

of comparing the time duration of about 20 rounds with a time base (usually the 60-cycle line frequency), the rate being calculated from the tape.

The rate-of-fire indicator here described was developed to fill the need for an instrument which could be more conveniently used where

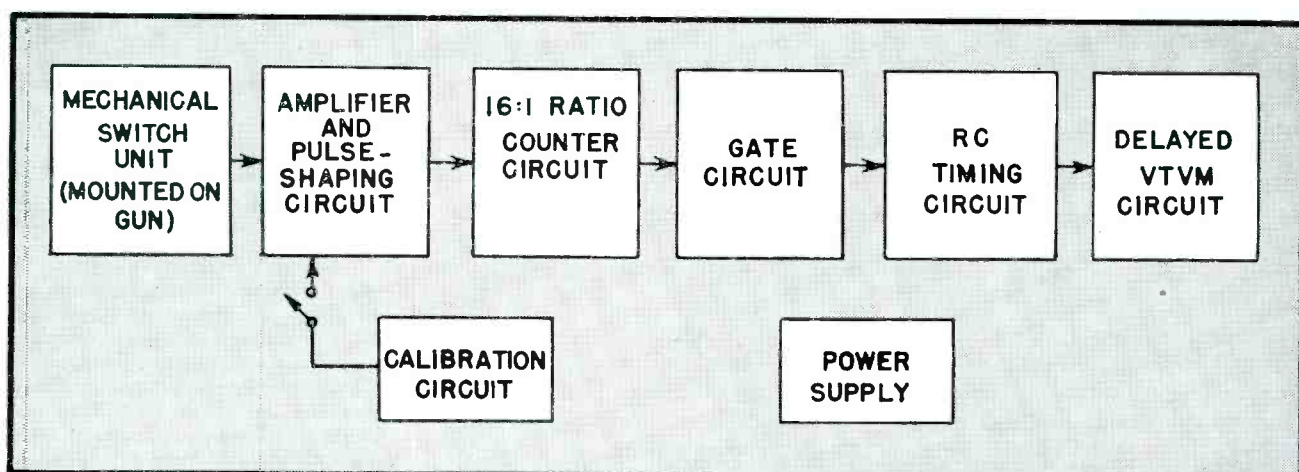

FIG. 1—Block diagram of machine gun rate-of-fire indicator

Rate-of-Fire Indicator

Electrical impulses initiated by a mechanical switch are counted and timed by a series of five Eccles-Jordan trigger circuits and the rounds per minute indicated directly by a vtm.

Non-military production uses are indicated

into negative pulses of short duration and impressed on the grid of the input amplifier to be limited to the proper amplitude for the triggering of the counter circuit.

The timing circuit is controlled by the counter and its associated gate circuit in such a manner as to start and stop the timing action of the timer according to the time required to fire 17 rounds. This time interval is thus a direct measure of the rate of fire. A timing capacitor is charged for the exact duration of the counting period, and the resulting potential of the capacitor is a function of the charging time. This potential is measured by a delayed vacuum-tube voltmeter which is calibrated to read in rounds per minute.

Counter Circuit

Since the primary requisite of the counter circuit is to control the timing period of the timer according to the rate of fire, the counter cannot introduce any time error. This is not true with simple counter circuits based on the accumulation principle, where the occurrence of each pulse causes a capacitor to charge step by step until a predetermined potential is reached which permits a trigger tube to respond. Since the grid potential at which a trigger tube responds is never exactly constant, a time error results, as illustrated in Fig. 2.

Due to the resistance of the driving circuit, the voltage of a capacitor cannot be changed instantly. Therefore, the leading edges of the steps are not sufficiently steep to reduce error to within an allowable tolerance. For this reason, counter circuits based on the trigger principle were used. A series

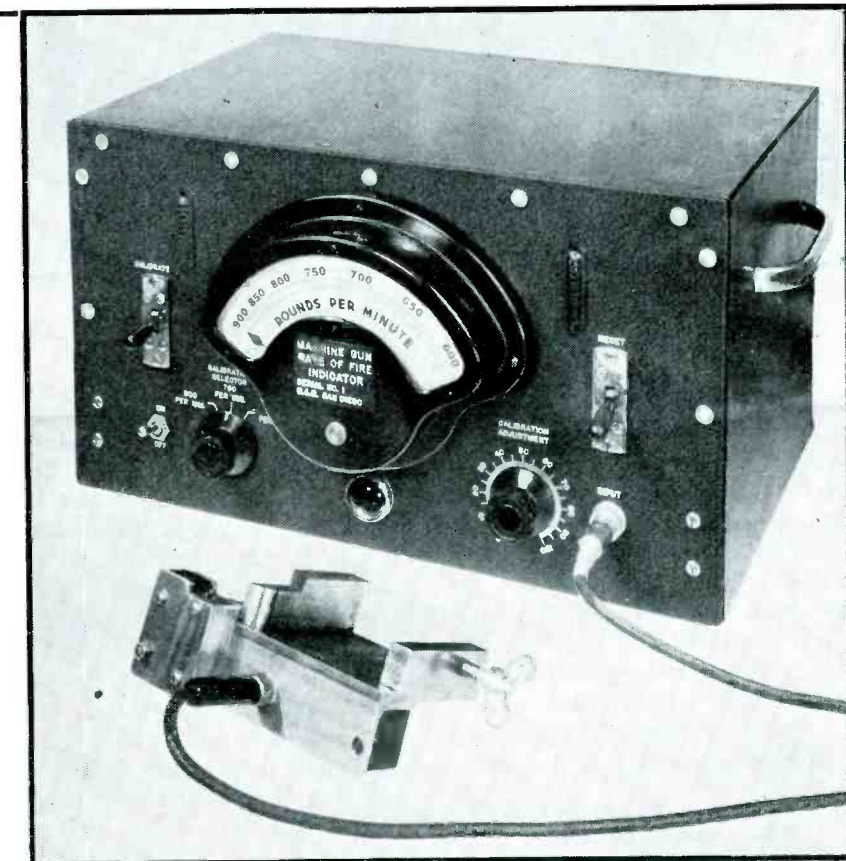

Front view of machine gun rate-of-fire indicator, with mechanical switch that clamps on gun and closes a circuit once for each round of ammunition fired

of five Eccles-Jordan trigger circuits provides a counting ratio of 16 to 1.

The operation depends upon each stage having two conditions of stable equilibrium. Every impulse impressed on the input circuit causes a transition from one state of equilibrium to the other, two impulses being required to complete one cycle. Each stage following the first receives a negative triggering impulse upon every alternate operation of the preceding stage. Hence, the fifth trigger stage, which functions to control the gate circuit, remains in one state of equilibrium for the exact duration between the first and sev-

enteenth rounds, or 16 intervals.

Any number of rounds between 17 and 32 can be fired but only the first 17 are counted and timed. A reset switch is provided for the purpose of restoring each trigger circuit to its initial state of equilibrium, and also to discharge the timing capacitor in preparation for a firing test.

Two neon lamps on the front panel (see photos) are connected to the first and last counter stages, and serve as an added check on the operation of the instrument. The lamp at the right should ignite on

The views expressed herein are those of the author and do not necessarily reflect the views of the Navy Department.

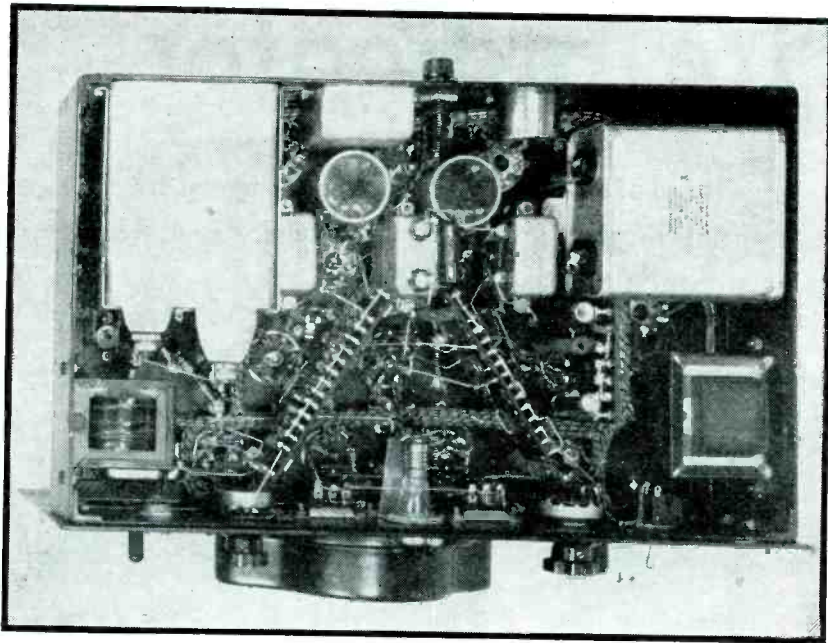

Under-chassis view of machine gun rate-of-fire indicator

the first impulse and not extinguish until the 17th impulse, while the lamp on the left should glow on every other impulse from the mechanical switch.

Loctal type 7N7 tubes were used in the trigger circuits since the two triode sections of this tube have more identical characteristics than those of the equivalent type 6SN7 tubes. The mutual conductance of one section of a 6SN7 tube is greater than that of the other section.

Timer and Gate Circuits

Most electronic switching arrangements which suggest themselves are not suitable for use with a delayed-bias vacuum-tube voltmeter, since the timing capacitor must charge from zero or its initial potential to a more positive potential so as to exceed the cutoff bias of the vacuum-tube voltmeter. If a vacuum tube had been used as the switching mechanism, a timing capacitor in the cathode circuit would have been required to obtain a positive rising potential. Such an arrangement results in undesirable leakage resistance between cathode and filament of the tube, or between the filament winding of a transformer and ground, as the case may be.

These problems and the accuracy required imposed special considerations for the electronic switching

and timing circuits, resulting in the development of the design shown by the schematic circuit in Fig. 3. In principle, the zero bias voltage on the grid of the gate tube causes the tube normally to conduct, and the current flowing through the plate load resistor results in a plate voltage of less than the igniting potential of the neon switch lamp. The potential of the timing capacitor is zero, it having been fully discharged during the operation of the reset switch.

Upon firing the first round, the final trigger circuit shifts its state of equilibrium, initiating a negative gate pulse which drives the gate tube far beyond cutoff. Since the RC time constant of the input circuit is longer than any interval to be measured, the grid remains

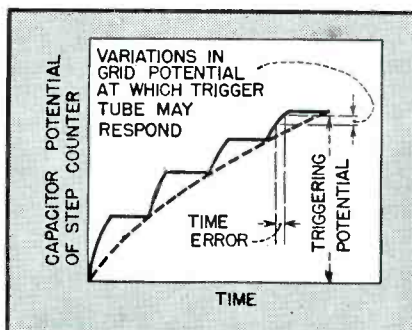

FIG. 2—Characteristics of a conventional step counter, illustrating time error

cut off until the end of the gate pulse.

Thus, the gate tube has an output pulse with an amplitude exactly that of the regulated power supply, as shown in Fig. 4. This voltage is applied to the neon switch-lamp, causing it to ignite and start the charging of the timing capacitor. The voltage of the capacitor increases exponentially at a rate determined by the RC time constant.

After the 17th round has been fired, the final trigger stage reverts to its initial state of equilibrium and a positive pulse is suddenly applied to the grid of the gate tube. This reduces the plate voltage to a value below that of the extinguishing potential of the neon switch-lamp and cuts off the RC timing circuit, leaving the capacitor with a definite charge.

By this time, the timing capacitor has charged to a potential more positive than the plate voltage of the conducting gate tube, resulting in a sudden reversal of voltage across the neon switch-lamp as it extinguishes. This reduces the deionization time and the error which would result from an inconsistent deionization time.

After the circuit through the neon switch-lamp has been cut off, the timing capacitor should retain its charge over a reasonable period of time, to prevent the meter reading from drifting. The extent to which this can be accomplished depends upon the leakage of the capacitor itself and its associated circuit elements.

Leakage currents were minimized by removing the base from the neon switch-lamp, replacing insulation of the reset switch with polystyrene, designing the vtm to have high input resistance, and using a special timing capacitor having very high leakage resistance. Oil-impregnated capacitors are now available with leakage resistance in the order of 20,000 megohms per microfarad. Such a long RC time constant makes possible the holding of the charge on the capacitor without loss of more than one percent in over three minutes.

The main consideration in the vtm design was to obtain a high input resistance and a high degree of accuracy.

A type 6C4 miniature tube was used because its electrodes pass directly through the glass, greatly increasing the insulation resistance as compared with ordinary tubes. Some input conductance also results from initial electron velocities emitted by the cathode. This was reduced by operating the heater of the vtvm at reduced voltage.

Filament voltage regulation of the vtvm was found to be advantageous in maintaining meter calibration independent of line voltage fluctuations, especially when operating the heater at reduced temperature.

Time-Delay Vacuum-Tube Voltmeter

The voltage applied to the timing circuit, the plate voltage of the vtvm, and the delay bias voltage must be well regulated. A two-stage cascade voltage regulator is used for this purpose. The regu-

lated output voltage which is applied to the timing circuit is adjustable plus or minus 2.5 percent from the front panel. This control is provided for making calibration adjustments to compensate for the effect of temperature variations on the timing circuit.

The range of the vtvm is determined by the value of the degenerative feedback resistance in the cathode circuit and the meter damping resistance.

If for any reason the gun should not completely fire the full number of rounds necessary to stop the timing action, the timing capacitor would continue to charge until the grid potential of the vtvm approached zero. The plate current would then overload the meter. To remedy this condition, an overload relay is used in the meter circuit and operates when the current exceeds full-scale readings.

The meter scale is non-linear because rate is an inverse function of time. This was also a reason for using delayed bias, since the meter would have otherwise read from infinity to 600 rounds per minute.

The divisions of the meter scale are individually calibrated. Calibration points were established by means of a variable low-frequency generator of known accuracy. The output of this generator was used to operate a polarized relay, the contacts of which were connected to the input of the indicator in the same manner as the mechanical switch unit.

Calibration Circuit

The accuracy of the indicator is greatly increased by means of a calibration circuit which generates pulse-repetition frequencies for checking and adjusting the meter indication. The greatest accuracy is

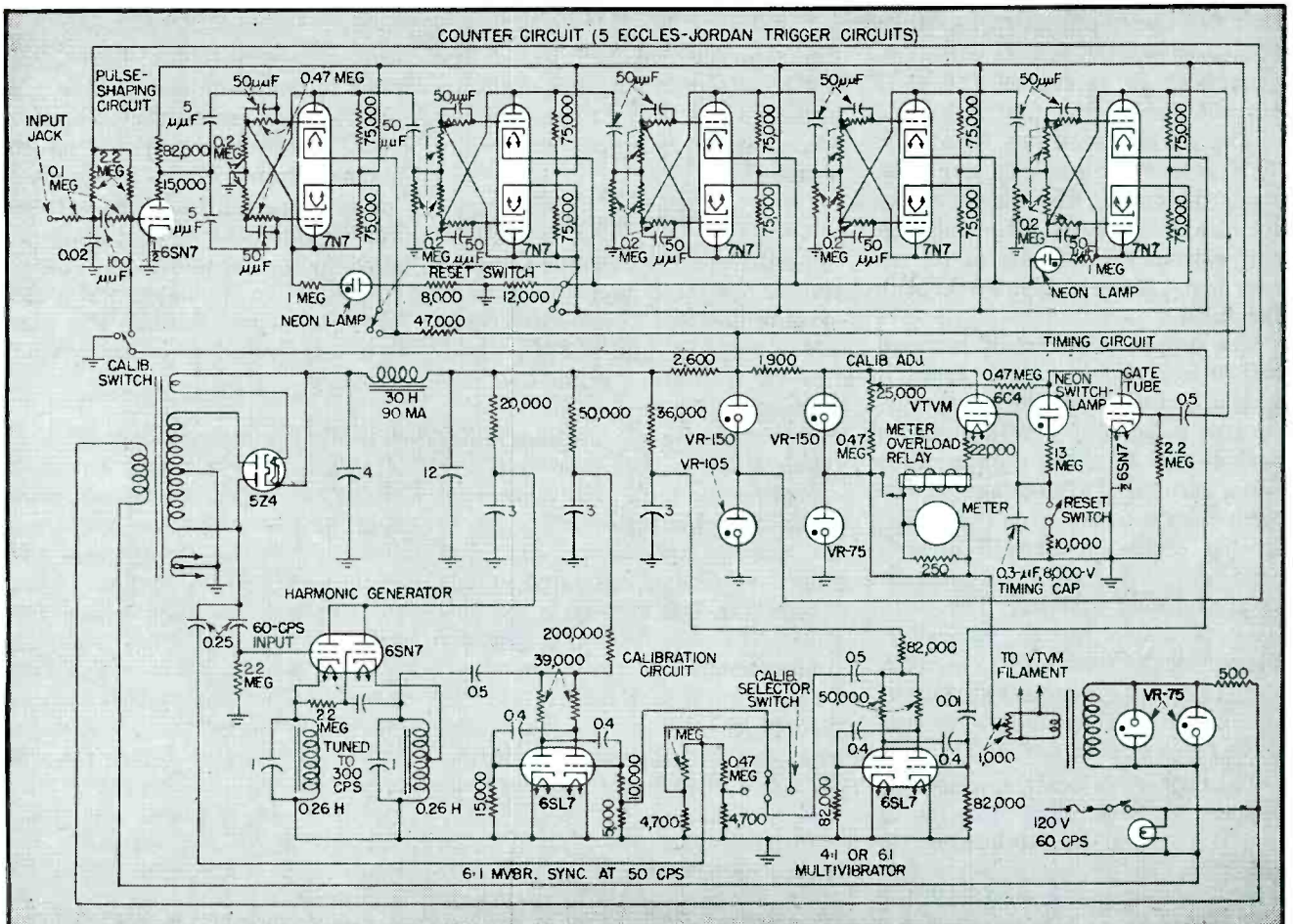

FIG. 3—Circuit diagram of rate-of-fire indicator, capable of indicating directly on a meter the rate of occurrence of any industrial or other operation in the range of from 600 to 900 operations per minute. The circuit can readily be adapted for other ranges

By **L. E. PINNEY**
Assistant Professor of Physics
Iowa State College
Ames, Iowa

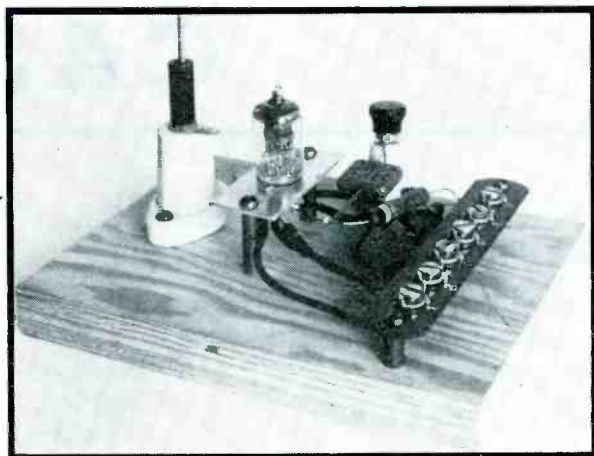

FIG. 2—Experimental mixer layout. The large stand-off insulator supports a three-foot antenna; the small stand-off connects to the antenna post of a conventional receiver

Checking UHF Oscillator Stability

Design of a simple mixer that permits heterodyning an uhf oscillator against a crystal-controlled multiplier. The difference frequency is fed to a conventional receiver to observe frequency shift

FOR COMPARING oscillator frequencies by the heterodyne method, the simple circuit shown in Fig. 1 has been used with excellent results. The device is used with an ordinary all-wave radio, or better, with a communications receiver which responds to the difference frequency of the two oscillators. Audible response is obtained by heterodyning the intermediate frequency of the receiver

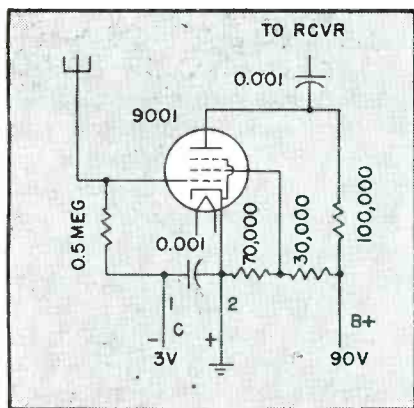

FIG. 1—Untuned mixer for comparing the frequency of an uhf oscillator with that of a crystal-controlled multiplier. Terminals 1 and 2 may be connected together if a plate potential of 45 volts is used

to a suitable audio frequency, as in c-w telegraph reception, or by modulating one of the oscillators.

The antenna post of the receiver is connected through a capacitor to the plate circuit of the mixer shown in the diagram. This connection is made at the binding post on the small stand-off insulator, visible in Fig. 2. The mixer-unit antenna is a suitable length of heavy wire, ordinarily about three feet, plugged into the larger stand-off insulator.

Optimum values of external grid bias for the mixer range from 2 or 3 volts with 100 volts on the plate to zero at 45 volts on the plate. Since operation at the lower voltage is often quite satisfactory, it has been found convenient in such cases to connect terminals 1 and 2 together and to use a 45-volt B battery. The plate current at this voltage is about one milliamper. Grid-leak bias might also be used at higher plate voltages by omitting the grid-return capacitor and adjusting the grid resistor.

The oscillator whose frequency stability is to be observed is operated in the same room with the

mixer (which is connected to the receiver) and a crystal-controlled frequency multiplier that gives a very stable signal at about 112 mc.

Operation

The oscillator under test is adjusted to a frequency such that the difference between it and the frequency of the crystal-controlled multiplier may be tuned in on the receiver. Thus, if the oscillator under test operates at a frequency of 100 mc, and the receiver is capable of detecting frequency variations of 1 kc, frequency instability amounting to 1 part in 100,000 may be observed. For maximum sensitivity, the difference frequency should fall in the range of highest resolution of the receiver. For most receivers, this optimum value is in the lowest frequency band.

Since the mixer is essentially untuned, it will respond to all the lower frequencies used in communications. Nearby broadcasting stations may be heard at almost any setting on the receiver dial by operating an ordinary test oscillator, adjusted to a suitable frequency, in the vicinity of the mixer.

CASE STUDIES

DURING the past two years, the following four production problems were encountered and solved in the plants of four electronic equipment manufacturing companies.

Problem No. 1

The first problem involved setting up the process and increasing production on four units comprising a uhf radar receiver. It consisted of a mixer-converter, power pack, i-f section, and video sweep section which were assembled on separate lines and later combined with additional equipment as one complete unit which moved first to company inspection and testing and

then to Government inspection and final test.

Figure 1 shows the floor layout where the problem was handled. Note the proximity of all major sections to each other. Resistor boards, cabling, and other sections were set up as subassemblies and, because of required compactness, each was small.

Since the workmanship required was very exacting and the work often inaccessible, this was no mass production item comparable with

those found in the three succeeding problems. Workers needed on assembly, wiring, and soldering required skill considerably higher than that found in average factories. Thus a school was maintained separate from production. There, every girl was taught to read resistor and capacitor values, wire stripping, tinning, and all types of soldering. Under the supervision of an experienced teacher, workers left the school as skilled mechanics.

The first unit to consider is the converter section. The chassis itself was 4 x 9 in. Into this small space were crowded 6 tubes, 5 jacks, 90 screws, 44 nuts and about 125 solder joints, with a large number of other parts. To add further production difficulties the chassis was subdivided with panels.

There were two ways to consider handling the converter section: (1) having wires and parts crimped by one operator and connections soldered by another, or (2) having each operator responsible for wiring and soldering a complete box. We tried the latter. This job required very skilled girls in each position. By the first method we could have sandwiched in fewer skilled operators.

The first operator on assembly had about 25 solid parts to assemble into the chassis. So a ramp storage shelf was built for this position as indicated in Fig. 2. The ramp was made of plywood. The boxes were paper and nailed into the stand. In back of each box (X) was included on a white paper strip pertinent information about the parts in the box. This strip was fixed into place with transparent Scotch tape.

Good features of the ramp were its low cost and re-usable value and the fact that the supervisor could tell at a glance what parts or hardware were needed. The operator

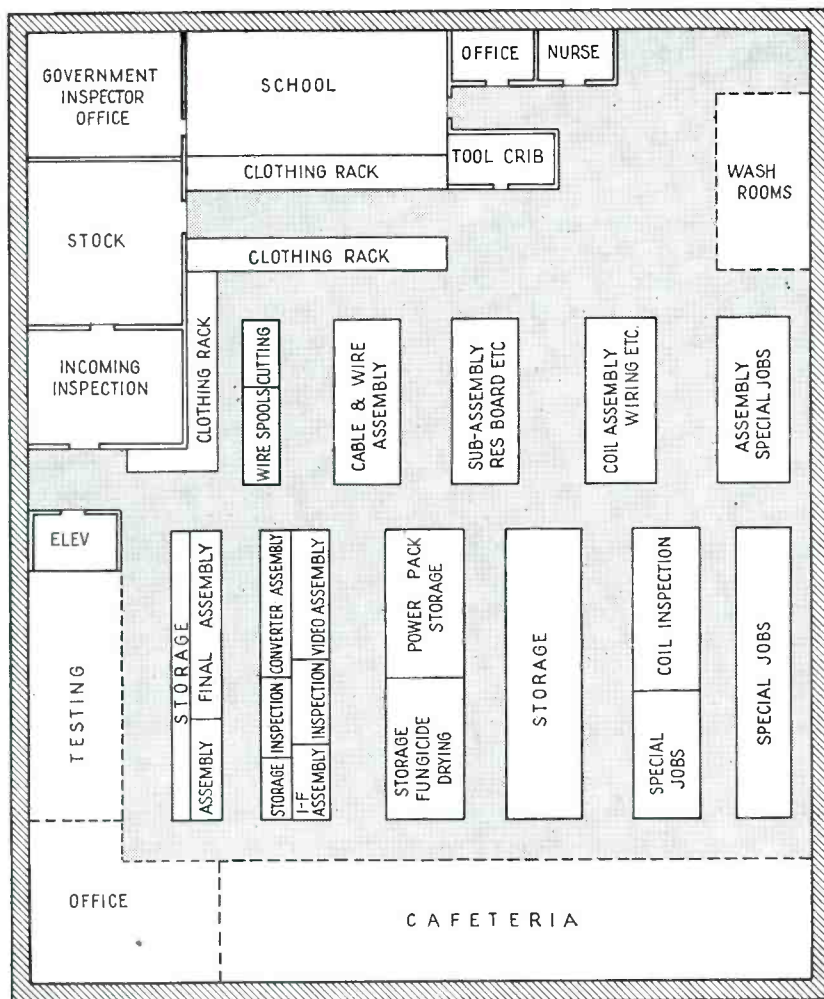

FIG. 1—Production-floor layout for radar manufacture described in the text under problem No. 1

OF PRODUCTION

Details of what one engineer did to raise productivity in four different plants manufacturing electronic gear. He shows how consideration was given not only to the tangible jigs and fixtures but also to the more abstract factors of personnel relationships



A typical electronic equipment production line in action

was clocked working the same job with a conventional type half-circle parts holder at thirty minutes and with the ramp at twenty. Each box was fixed so the operator could follow only the set routine.

At the start, the first operator was assembling one tube socket or one part at a time. A jig was devised which cost about \$15.00. It is shown in Fig. 3. Now the operator could assemble 10 parts at one time. This was done by first assembling 20 nuts on a piece of rod, then dropping one into each Spin-

tite. In the same fashion a lock-washer is put on top of each nut. Then the chassis is placed downward on the Spintites, parts are set in place and the screws threaded home.

On the next assembly operation an all-purpose wooden hardware holder of the type in Fig 4A was being used. Slots were made for hanging-in small metal pans, as in Fig 4B, when additional storage was required for small parts, and a half-circle group of four wooden holders were utilized when the assembly operation warranted.

After the assembly section there was a storage pen made of shelving and 3-in. pegs of wood, like that in Fig 5A, so the sets could be stacked on end, while single sets were kept in pens of the type shown in Fig 5B.

For the chassis wirers and solderers wooden holders were made as shown in Fig. 6. They were made so the chassis could be reversed sideways for easier operation, and

the few parts required were directly in front of the operator. Tacked up within visible range was a blowup of the operation. Resistors, and sometimes the wires, were colored in these diagrams.

In complicated sets it is best to have a first-inspection tag on each chassis which means the chassis is complete and correct in every detail including stencils. This particular unit has $\frac{1}{2}$ by $\frac{1}{8}$ -in. stencils. If there is any great quantity of these it is advisable to use templates and a spray gun. The next

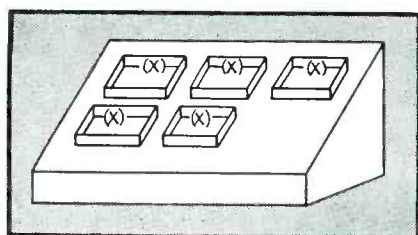

FIG. 2—Plywood ramp holds solid parts in storage for assembly. Identification is fastened in at X with transparent tape

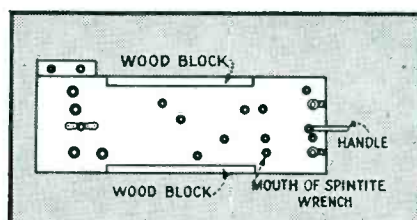

FIG. 3—Twenty Spintite wrenches incorporated into this jig made it possible for an operator to install ten parts on a chassis at once

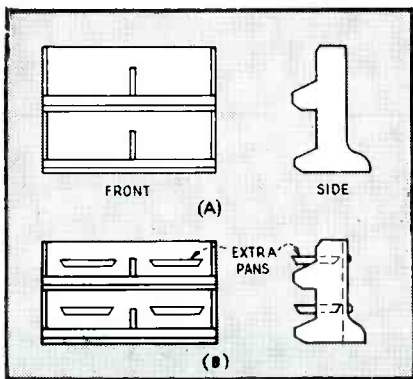

FIG. 4—Standard hardware holder, A, is modified as at B to give extra space for small parts at various positions on assembly line

inspection should follow the assembly section. The tag on the chassis will include the repairs found necessary, the initials of the repairer and the inspector's number. On critical, compact work, if an inspection is not made at this point the cost of repairs later is extreme. It also lessens the work and the field of inspection of the final inspector and chances of ultimate rejection by the government inspectors is much less.

In the i-f section, another jig of Spintites was prepared for seven tubes and jacks. This operation was cut five minutes with the jig. Originally, each operator tried to do wiring and soldering in the i-f section chassis on the table. A simple wooden holder was made like that illustrated in Fig. 7. This jig held the protruding coil cans firmly in place and could be moved or slid around at will.

Work being in an open chassis, things were arranged so wiring, jumpers, and resistors were crimped-in by operators and the chassis was moved down the line for another operator to solder these. Then the next operator would do more crimping and another more soldering. This method did not require all personnel to be highly skilled.

In order to keep coils on the line a bank of squares shown in Fig. 8 was used.

For the power-supply section a simple jig was developed for mounting can-type capacitors. The operator inserted the can into a metal holder, then pushed the bare chassis down and installed the necessary lockwashers and hex nuts.

This method saved about three minutes on each chassis. Also, operators will do better work if a chassis has a solid or firm foundation under it while they perform their operation.

In the video section the assembly operator was spending fifteen minutes to assemble three tube sockets, which had a fixed and springy tube clamp. An assembling tool, Fig. 10, was made inexpensively of $\frac{1}{8}$ -in. tool rod. With this tool, which cost about \$8, the oper-

operators from continuously blocking the light, and from becoming fatigued by bending over.

Problem No. 2

The second problem to be met concerned production of 8-tube recorders, subassemblies and assembly and wiring for uhf amplifiers and generators. The results were as follows: Recorder labor costs were cut from \$20 each to \$11. Subassembly labor time was reduced 60 percent. General production of main assemblies increased 70 percent.

The floor section was set up as shown in Fig. 13. Note that wire cutting and cabling adjoin and that both are close to the production sections.

The recorder chassis was cumbersome because side brackets which can be seen in Fig. 14, were being assembled at position one. A chassis should be easy to handle on a production line. Assembly of brackets was changed to the end of the line.

Tables were covered with heavy paper so the chassis could be slid along in an upright position. All heavy wires were put in first, close to the chassis. Then jumpers and connections were added.

Supplies were prepared for solid runs of 50 units at a time and production stock control sheets were kept up to date—weekly for an overall check. After a time check for each position the process was set so that the assemblers were at least a few units ahead of the capacity of the three lines.

In the cabling section, production was increased 25 percent by the use of colored lines and tracers to duplicate the cable proper. This was on a large board slightly to the

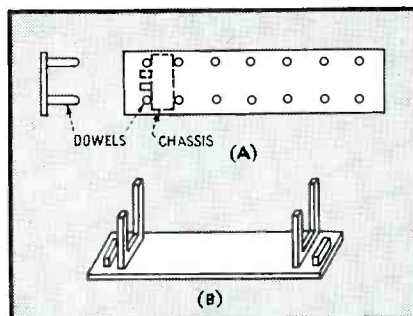

FIG. 5—Following assembly, radar chasses were stacked on end in pens like A. Rack B serves similar purpose for a single unit

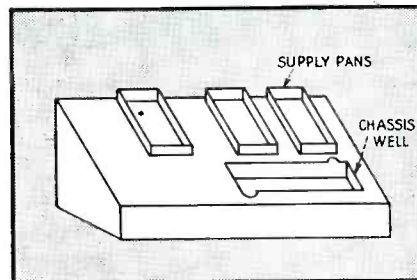

FIG. 6—Many wiring and soldering operations were handled in ramps like this. Chassis-well was made to hold units in several positions and at proper angle for light and access

ation was cut from fifteen minutes to five and a half.

The video-section line required one operator to insert four cables of different sizes and colors, so the holder of Fig. 11 was contrived. It was made of light wood and just about 4 inches short for each cable so the protruding cable ends could be grasped easily. The highest point was within easy reach of the operator.

Some simple chassis holders were made of wood. See Fig. 12. With this pitch, the most light from overhead reached all parts of the set. The arrangement also prevented

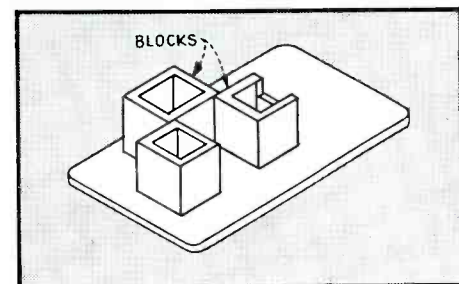

FIG. 7—Chassis holder of this type steadies inverted unit for wiring and facilitates soldering

left of each cabler. Smaller cabling boards were put on swivels, as seen in Fig. 15. These are easy to swing yet they bind while a girl is working.

On resistor board subassemblies we cut labor time about 30 percent by using a small rack of step-up shelves as shown in Fig. 16. On these, tagged paper boxes were directly in line of vision of the operator. Each box was nailed down so it could not be moved. It was set to follow the process in correct sequence. This eliminated lots of errors. Resistors and mica capacitors were handled the same way.

For the wiring of resistor boards we used two devices shown in Fig. 17. For a 12-in. board wired on one side, Fig. 17A was used and, although there was a slight spring deflection when the girls wired, they liked it because it gave them a sense of openness and freedom while they worked. Another jig, Fig. 17B, was used for resistor boards from 3½ to 6 in. in length. Large resistor boards were divided into three operations. First, crimp jumpers, base wires, and sleeved wires; next, set-in wires and some resistors; third, finish crimping and solder all connections.

Hot irons and carbon tetrachloride fumes are not pleasant, so cleaning of solder joints was done well along at the end of the table. However, if the solderer is taught to hold her iron just long enough to get a clean finish on the joint, there never need be too much rosin there. This time factor depends on the thickness of the solder, its alloy, and the size of the iron, and it can be determined by the supervisor who makes a few practical tests himself. Thousands of connections were made which required no cleaning.

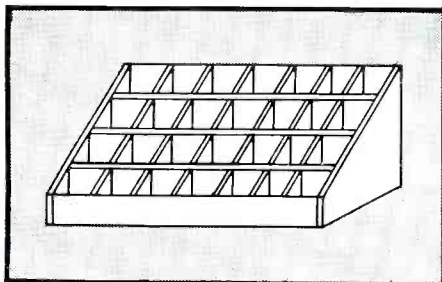

FIG. 8—Bank of squares was made to size for holding a supply of coils at their assembly point on the line

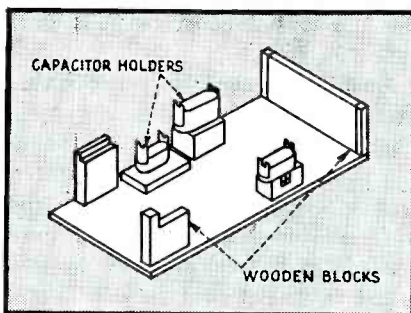

FIG. 9—Can-type capacitors were added to chassis with the aid of this kind of jig. Holders were loaded first, then the inverted chassis was dropped on top and washers and nuts put in place

For the large high-frequency amplifiers and generators, each operator had a little moveable stand as illustrated in Fig. 18, with each wire identified and its ultimate connection shown. This was enclosed in a thin plastiglass cover to keep it clean. It is advisable to make these for operations which exceed twenty connections, both to prevent forgetting over a weekend holiday and to guide a new operator.

Problem No. 3

The third problem was to improve production on power-supply units used for aircraft high-frequency transmitters. Production of 190 per month was increased to over 1000 per month in five weeks with the labor force increased 25 percent. Production cost at 190 per month was \$15.00 each; at 1000 per month, \$4.50 each.

On the mechanical assembly line, large terminal lugs were being removed from 4-in. upright can capacitors and replaced with smaller ones. A girl was holding the can in her left hand and using an open-end wrench with the other. She was doing about 110 per eight-hour day. A simple fixture like that in Fig. 19 was made and fastened to the table. The cans were inserted into the sockets, leaving the girl's left hand free. Two days after the jig was used a normal day's run for the same operation was 260 per day.

Another operator assembling 4 tube sockets into the chassis used an assisting jig which had an unsteady base. She was doing 25 units a day. The jig was placed on a wider paddle base. Her production moved up to an easy 55 per day.

An operator on the assembly sec-

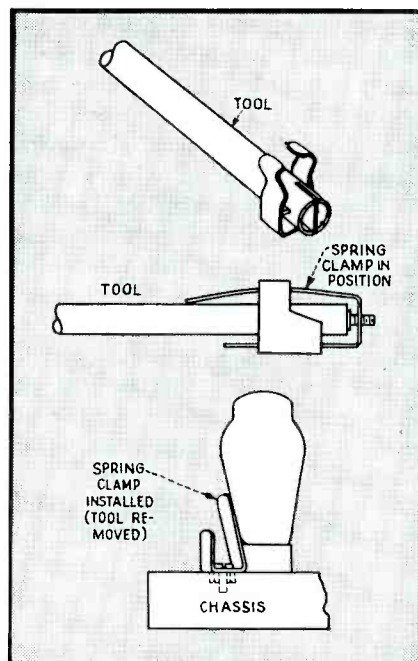

FIG. 10—Special tool saved 9½ minutes on each unit in the assembly of three tube sockets and clamps. Made of ½-in. tool rod, it cost about \$8

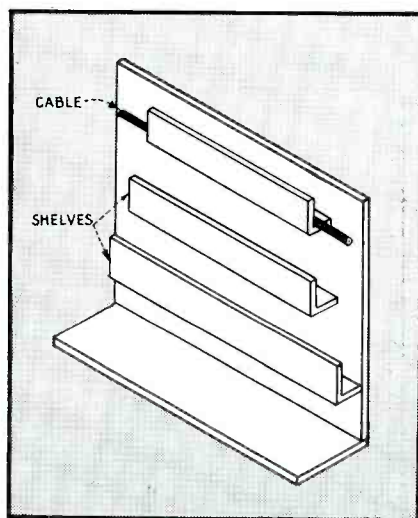

FIG. 11—Angle shelves were designed to hold four different cables for installation in chassis. For easy grasp, shelves were about four inches shorter than cables

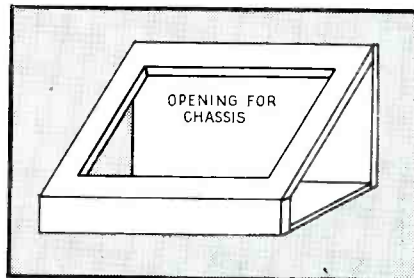

FIG. 12—Angle of pitch in this wooden chassis holder is such as to combine good light and a restful working posture

tion had to assemble 4 No. 8 round-head screws through a front panel into 4 stop nuts. The foreman had used 5 different men and women on this job in the course of six weeks. Each one wound up with a lame shoulder or a weak wrist. Investigation showed there was no holding jig for the unit and that the seated operator used a heavy 14-in. screwdriver. This operation was a bottleneck. An operator could only do about 30 a day by this method. A heavy screw cutting its own thread into a stop nut is hard work, after the first dozen.

Three 1 by 1-in. wooden strips were nailed on the table to stop the chassis from moving and the operator was supplied with an ordinary carpenters' ratchet screw driver. There were no more lame shoulders and sprained wrists. The practice had been to use an open-end wrench on the inside of the chassis—the operator holding one stop nut at a time. The simple steel jig shown in

Fig. 20 was devised to hold four nuts at a time.

Most of the assembly work in this particular case was done by men. There still persisted the old bugaboo that a woman couldn't tighten up a screw and nut. The men, who were all too scarce anyway, were needed for heavier work so we had to use women or stop the job. Therefore, we taught girls who figuratively never saw a screwdriver before how to do a good job. They listened and they were shown how.

We got the correct screw driver to fit the particular screw slot. We got them correct chairs, taught them how they could burr a screw and how to avoid it, and showed them how to rest while they threaded the screw and only use pressure in the last turn and a half. Wherever possible we used a Spin-tite or a combination with a short holding screw driver. After two weeks women were producing more than the men.

Production of a five-tube super-heterodyne receiver was to be raised from 70 each 8-hour day. Three weeks later it was 190-210 each day.

Here's how it was done:

Main production lines were set up with other sections nearby as shown in Fig. 21. Note that machines and heavy noisemakers were kept away from the assembly lines and that there are numerous storage spaces for sets. Notice also the accessible position of the cage.

The chassis itself was about 6

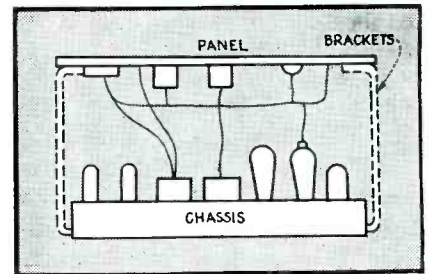

FIG. 14—Open side view of recorder. Panel and chassis were joined with side brackets at the end of the line instead of at the beginning of the line to keep the chassis easy to handle

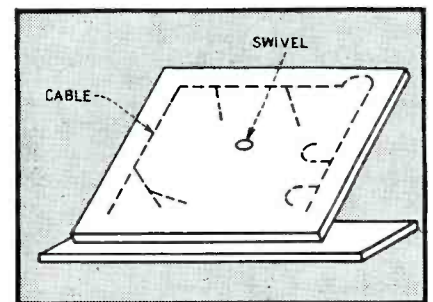

FIG. 15—Swivel boards for wire cabling turn easily but bind under pressure of operator's hands. A drawing of finished cable is taped down on board and nails and cleats added for cabling to follow

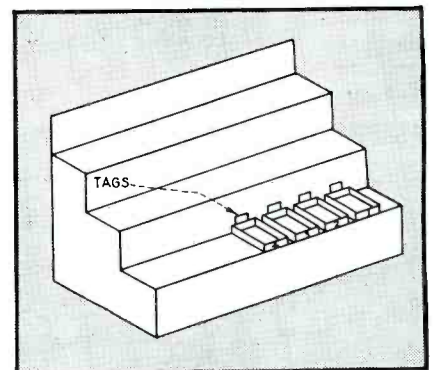

FIG. 16—For subassembly of resistor boards, parts boxes were fastened in position and tagged as shown. Ideal location is at eye level

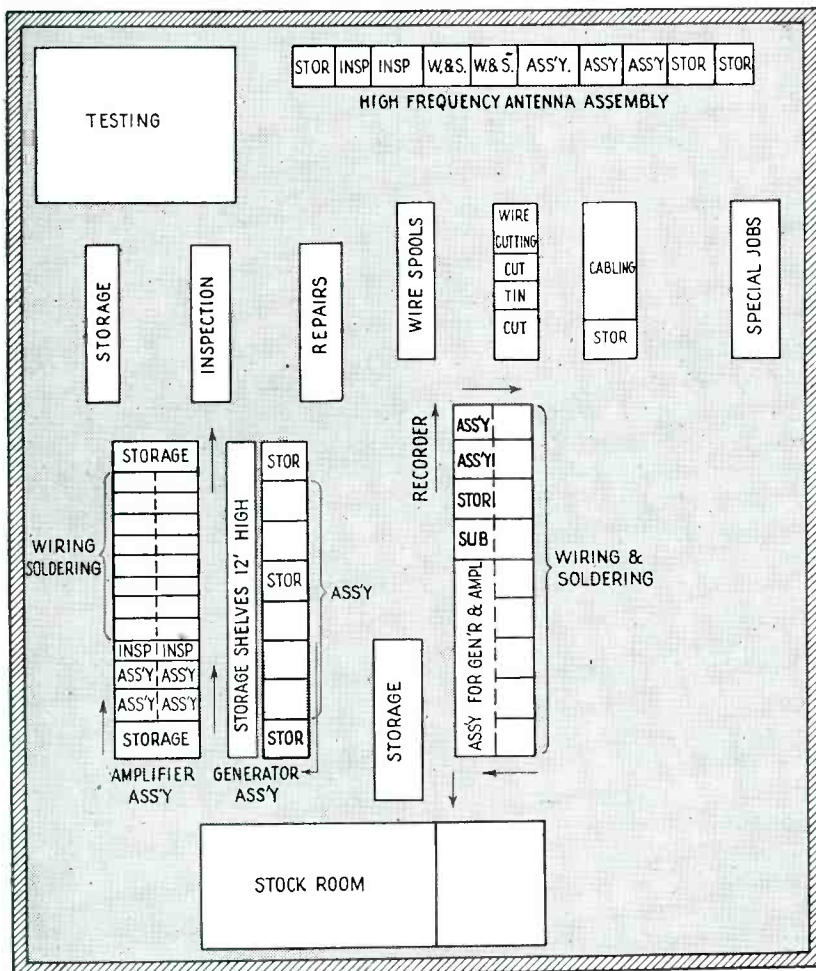

FIG. 13—Plant arrangement on recorder, amplifier, and generator project listed in the text as problem No. 2

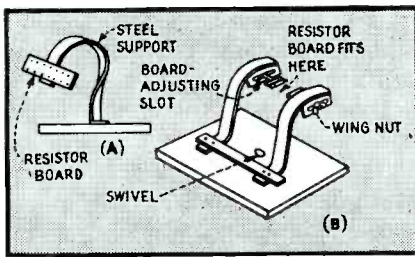

FIG. 17—Holding jig for 12-in. wiring resistor board is shown at A. Operators like it because of accessibility. Double-sided boards were wired in a fixture like B, which revolves

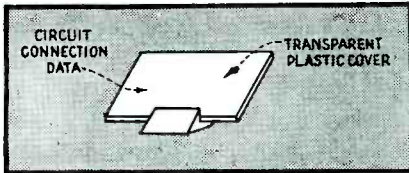

FIG. 18—Where an operation includes more than twenty connections, a small movable stand is helpful to display a sketch of wires and connections. Data is covered with sheet of transparent plastic to keep it clean

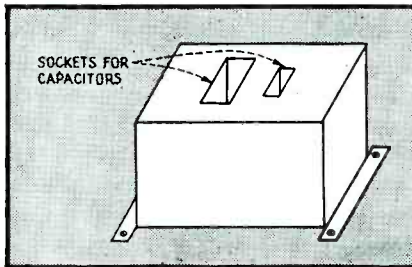

FIG. 19—Fixture designed to hold can-type capacitors while an operation was performed on the connecting lugs. This arrangement left both hands free

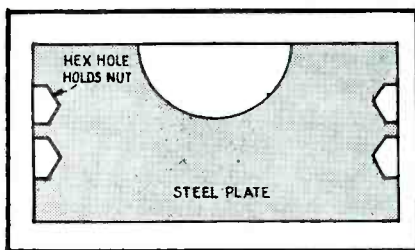

FIG. 20—This unit replaced an open-end wrench for holding four stop nuts behind a panel while screws were driven through with a carpenter's ratchet screw driver

by 11 in. and was set up on a jig and ramp combination as illustrated in Fig. 22.

For assembly of the i-f coils and the capacitor gang we used two power-driven screw drivers. These were on balanced pulleys which swing easily up or down. With these, production time on this operation was cut from 4 minutes to 1 minute even.

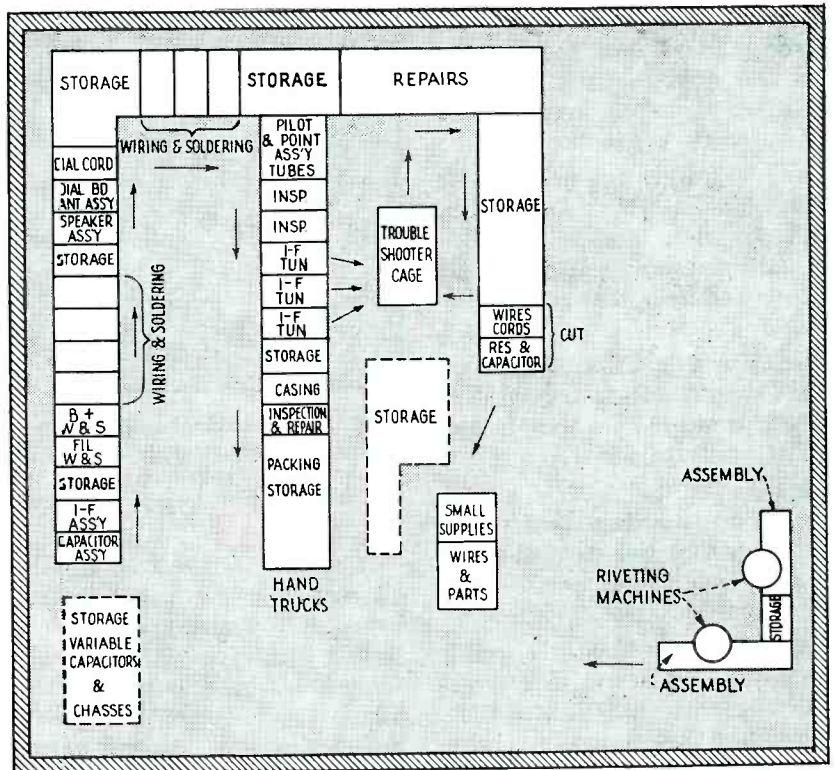

FIG. 21—Five-tube superheterodyne receivers were built in this layout, discussed under problem No. 4. Noisy riveting machines are well away from other operations

Tube sockets were being riveted by operators who had not been trained to judge their foot pressure correctly. As a result they were battering rivets and wasting lots of motion and time. After three days of careful instruction, 200 units a day were rolling away from these two.

After making a time check of each position, all operations were broken down to 1½ minutes. Each operation was simplified. All resistors, wires, paper capacitors, and cords were pre-cut to size.

An accurate metal-on-wood jig was set up for the speaker assembly and it increased production 200 percent. All operators had a good supply of parts before them at all times.

One operator learned or worked faster than another. If she piled up her next neighbor, these extra sets were stored in boxes elsewhere and worked into the line a few at a time about two weeks later.

If one operator was too fast for her operation, part of a slower operator's work would be diverted for her to help out. Eventually it became incorporated into her operation. This way a line can be balanced.

All supplies were put into fixed boxes on ramp stands. They were so set and filled that they had to be picked from right to left in an order we believed to be the best method.

Each operator was encouraged to memorize every point-to-point connection to cut out waste motion. With a little patience most of them knew their job thoroughly after the second day.

Problems with People

The following are notes on the psychological factors involved in the various projects which have been described.

At the plant involved in Problem No. 2, too many men and women were spending too much time in their respective rest rooms. It was pointed out to supervisors and employees, tactfully, that a longer and more healthful life would be induced at the work tables than in smoke-filled rooms.

For a week or two, a few workers who were lagging were shifted every few days to give them a sense of shortlived security. It worked wonderfully.

Indifferent supervision in the past had resulted in a loss of any

feeling of responsibility by the workers. So we had to prove to them that what they did was final. Repair work was not brought back to them on the production line.

In order to get the first girl on wiring and soldering to spark the line, a few were tried at this position until one was found who could feed the line more than it could absorb.

During overtime, assemblers were taught how to solder. It paid dividends when other lines were in dire need of first-rate solderers.

Changes in the production line were not made during the first few days. This time was devoted to observation and notes were made away from the tables.

The changes which did result were made slowly and carefully—either one or two things at a time. Where lines have to continue operating to maintain a minimum quota, any change, no matter how small, must first be approved by the operator. She must be sold the idea, otherwise the foreman or engineer will meet the proverbial stone wall.

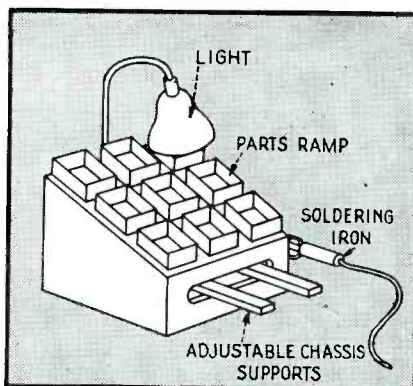

FIG. 22—Chassis-holding jig and parts ramp were combined in this unit for assembly of five-tube receivers. Note soldering iron in support at right

It is usual for the average assembly section to move with the same tempo as the wiring and soldering section which follows. At plant No. 3, however, time was of the essence. Simply to add operators was out of the question. We couldn't get any. The big problem was to have operators do 60 sets a day where they had been doing 20.

So the assembly section alone was kept working overtime the first week. The units were loaded on trucks and kept right at the head

of the table for the wiring and soldering section. There they stood in plain view for all to behold.

Combined with this spur to activity was the excellent co-operation of the first wirer who fed the line at a rate of 60 a day.

One man was appointed as a material expeditor. His duties required a visit with each foreman twice a day. It was his job to act as liaison between production, stock, and purchasing. This arrangement kept the foremen at their respective lines. This man saved everybody lots of leg work, and his appointment was well worth the cost.

Frequently we were short of parts. When this happened, the unfinished units were not allowed to clutter up the tables. They were kept on trucks, shelves, or under the table, but never in direct sight of the workers. Later, when the parts were received, the unfinished units were fed into the line without interrupting the continual production pace.

In plant No. 4 one problem was to sell the operator who wired and soldered tube filament wires on the idea of producing 200 a day where she had been doing 70. She was asked to operate for a day as a guinea pig in time study. She practiced some of the suggestions she was given. Because of a desire to impress us, she cut down on motions, and her daily production gradually moved up to 200 a day.

An attempt was made to interest the people on the line in daily quotas. After a week each line was competing with the other to gain that quota. To spur this on, hourly figures were posted in four spots on the production line. This way the operators were being paced hourly to avoid spurts in production.

When an operator consistently had similar rejective work, it was brought back for her to repair. That way she learned to avoid the same errors.

Each worker was required to learn her job from memory. Previously they had spent 20 percent of their time looking at the sample. Each knew the difference between what was acceptable and what was not. They were shown concrete examples of each kind, good and bad.

PEOPLE in PRODUCTION

A worker must be kept interested in her job, no matter how small or monotonous. She must feel she is contributing an important part of the entire job.

Each worker should understand the part the completed unit plays in the final function of the gear.

A production line crew should work as a team. Each individual must depend on the others. It is surprising how this one element will cut absenteeism.

If possible, workers should be arranged so neighbors are friendly, without the extremes where cliques are formed. In the event one girl slows up or is absent, her two neighbors will absorb her work for a day or so.

Contingent on maintenance of production, encourage word games, charades, etc. Tests show production is usually increased.

The most effective way to keep women workers from spending too much energy talking is to have amplified recorded music. Tempo of inter-mixed popular and classical records should vary.

It is a good practice to shift workers around on the same production line. Thus each one gets to know three or four operations and can fill in during an emergency when others are absent.

Workers must respect the foreman, whether they like him or not.

Race, color, and religious belief need cause no friction if competition between groups is eliminated.

It is a good point for the foreman or even top management to sit down once in a while and work on the line. Not too productive. But fine for morale.

Get operators to give their work a quick visual inspection before passing it on. It takes a few seconds but often saves more by keeping rejects out of inspection.

A-C Galvanometer

Operating theory, circuit analysis, and design considerations of a highly sensitive null indicator for a-c bridges. Stability and ruggedness are adequate for checking product quality in manufacturing plants. Nulls are indicated by a 6E5 electron-ray tube



Exterior of the electronic a-c galvanometer, showing hooded indicator tube and operating controls. The indicator bias knob at the right has an associated on-off switch for 115-v, 60-cycle a-c power. Tubes and other components are accessible after removal of bottom plate

By **ARTHUR L. QUIRK** and **HENRY D. HALL**

Chief Engineer *Harvey Radio Laboratories, Inc.* Senior Engineer *Cambridge, Mass.*

USE of headphones as a balance detector for a vacuum-tube bridge is generally unsatisfactory in a manufacturing plant or its laboratories due to a high noise level. The electronic a-c null indicator to be described provides high effective sensitivity for this purpose by a combination of two factors—high optical sensitivity and high electrical sensitivity. It also constitutes a more satisfactory method of detecting balance of an impedance bridge used to check incoming electrical components.

If balance of the bridge is to be precisely determined it is almost invariably necessary to determine an increment of minute value. For easiest optical detection, which in

turn means greatest accuracy, the incremental angle must be as large a fraction as possible of the initial angle. This condition is realized with an initial angle of zero degrees. In another sense, this arrangement produces what might be regarded as optical amplification.

Indicator Circuit Requirements

In a type 6E5 electron-ray tube, a negative voltage of the order of 7.5 volts must be applied to the triode grid to cause eye closure (zero shadow angle), as shown in Fig. 1. Inspection of the characteristic of this tube shows that as the grid-cathode voltage is varied from zero to approximately minus 7.5 volts,

corresponding to shadow-angles of 90 and 0 degrees respectively, the cathode current undergoes but slight change. This fact permits the use of a cathode resistor to produce operating bias.

Balance, as applied to an a-c bridge, is frequently a relative term, since many times complete balance is not secured; in fact, the nearest approach to a complete null may represent a minimum signal of some magnitude. Under such circumstances the balance indicator, to be satisfactory, must be sufficiently flexible to permit two major accomplishments, detection of a very small signal, and detection of a very small change in a relatively large signal. The first of these is required to take care of practically complete bridge balance, while the second is necessary to cover the more common case in which the residual signal is comparatively great. With proper handling of the controls, however, balance can be just as sharply displayed for a residual signal as for a virtually perfect bridge balance.

The detection of a small signal imposes two basic requirements. In the absence of signal the eye must be closed, but not overlapped. This requirement is easily met by bias voltage developed across the 6E5

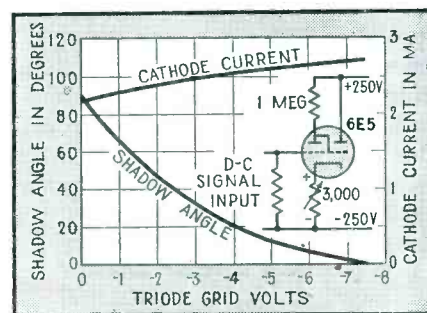

FIG. 1—Shadow angle vs grid voltage and corresponding change in cathode current for a type 6E5 tube used in the circuit shown

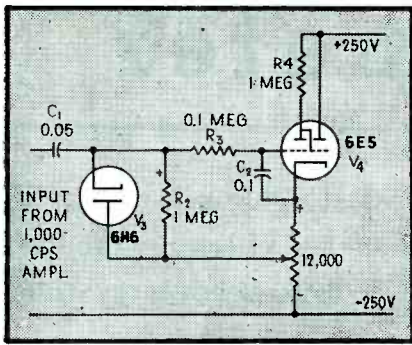

FIG. 2—Indicator and rectifier circuit

cathode resistor, which is preferably made variable. The second requirement is that the electrical sensitivity be high, and this is satisfied by a high-gain a-c amplifier which in this instance is tuned to 1,000 cycles.

Signal Rectifier and Low-Pass Filter

A signal rectifier and a low-pass filter are interposed between the amplifier output and the grid-cathode circuit of the indicator, as shown in Fig. 2. The filter is needed to secure sharp edges on the eye opening, since any rapid variation of indicator grid-cathode voltage would produce fuzzy edges. Obviously the filter has a longer time constant than is necessary to eliminate a 1,000-cycle ripple, but this arrangement helps minimize lower frequency a-c components such as 120 cycles. A still longer time constant would be desirable from the standpoint of removing 60-cycle ripple, but if the filter is made any larger the indicator becomes very sluggish. The chosen values seem to represent a good compromise.

The signal rectifier is so connected that the d-c output voltage acts in opposition to the initial bias. As noted above, the bias remains nearly constant for shadow angles from 0 to 90 degrees, and the small change is in a downward direction. Since it was a decrease in net grid-cathode voltage which produced this change the circuit is slightly regenerative, thereby causing a small increase in sensitivity.

Function of Rectifier Circuit

The 6H6 has a non-linear resistance characteristic in terms of the polarity of an applied potential, so that if the plate is positive with

respect to the cathode the resistance is relatively low, while with reversed polarity the resistance is very high. If the shunt resistor has a value sufficiently high compared to the forward resistance of the diode, the parallel combination will exhibit a marked difference in resistance between potentials of opposite polarities.

The diode V_3 and resistor R_2 in Fig. 2 constitute the major portion of the load on the 1,000-cycle amplifier. This means that, if the diode is neglected for the moment, an alternating potential will appear across R_2 . When the bottom end of R_2 is positive the diode will conduct and offer low resistance. On the next half cycle the diode plate is negative with respect to its cathode and will not conduct, thereby exhibiting high resistance. Since the driving source, the last amplifier stage, is a high-impedance device, it follows that the amount of voltage developed across its load is a function of the load impedance.

A low-impedance load thus develops a low voltage, while a high-impedance load develops a high voltage, so the top end of R_2 will average positive with respect to the bottom end. It is this voltage which after being filtered is applied between grid and cathode of the indicator, in series with the bias developed across the indicator cathode resistor. This new potential acts in opposition to the cathode bias, thereby opening the eye of the indicator.

For greatest rectification efficiency the resistor R_2 should be made as large as possible, but care must be exercised lest the resistance between grid and cathode of the indicator be increased to the point where instability appears. One megohm is a completely satisfactory compromise.

It is interesting to note that although the diode contact potential also acts in this circuit, its effect need not be taken into account because it is present at all times and is included in the initial bias adjustment (even though its value is unknown). Furthermore, tube noise and pickup within the instrument, and pickup in the bridge itself, can be biased out simply by turning off the bridge 1,000-cycle a-c source and adjusting the bias to produce eye closure.

Operation with Residual Signal

The detection of a small change in a relatively large signal requires that at balance the indicator shadow angle be zero degrees, and that the electrical sensitivity be high. In order to produce eye closure (without overlap) in the presence of signal, it is necessary to provide extra bias by increasing the cathode resistor shown in Fig. 1. Use of some 12,000 ohms, as shown in Fig. 2, produces a potential of 25 to 30 volts, depending on the individual tube. A portion of this voltage, ranging from a minimum of 7.5 volts to the full potential, depending on the magnitude

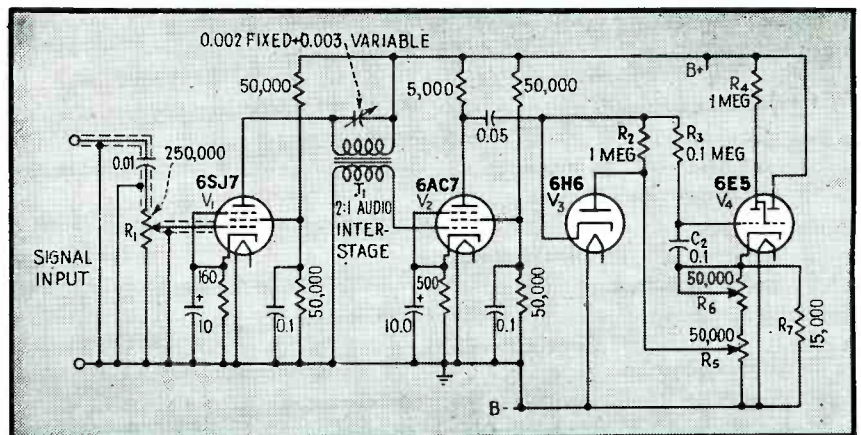

FIG. 3—Overall schematic circuit diagram of the electronic null detector. The conventional power supply is omitted. Sensitivity is controlled by R_1 , indicator bias by R_5 , and minimum bias by R_6 .

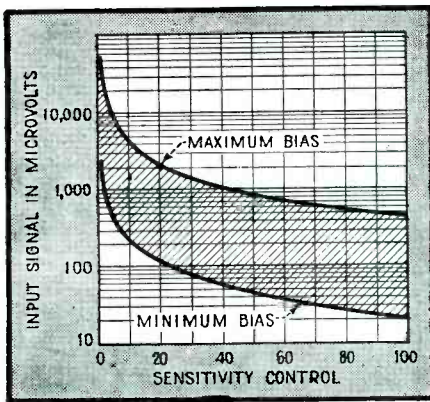

FIG. 4—Sensitivity control setting vs input signal for zero-degree eye opening over range of indicator bias

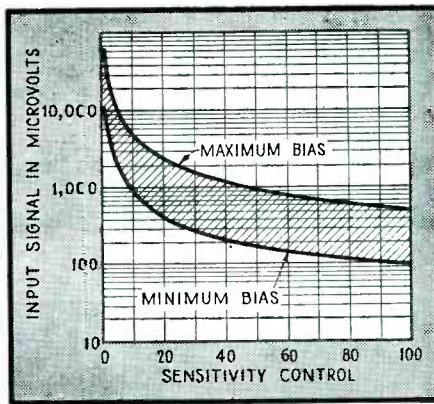

FIG. 5—Sensitivity control setting vs input signal for ten-degree eye opening over range of indicator bias

of the residual bridge signal, is applied to the indicator grid. When the algebraic sum of the two voltages is minus 7.5 volts on the grid the eye is closed, regardless of the magnitudes of the two individual voltages. The presence of extra bias and the absence of signal will cause the eye to overlap, and a certain amount of signal voltage is required to open it to the point where it is just closed. If the controls are correctly adjusted, the residual bridge signal, translated into a d-c signal, is just sufficient to produce zero-degree eye opening, while any departure from balance causes an increase in this signal which is displayed as an opening of the eye. The only additional requirement is that the amplifier must not overload under maximum voltage conditions, but this requirement is met by conventional a-c amplifier design.

Adjustment of Controls

The overall schematic circuit diagram appears in Fig. 3. The instrument is provided with two panel controls, one for sensitivity and the other for indicator bias. The sensitivity control is simply a gain control R_s in the input circuit of the amplifier, while the indicator bias control is a potentiometer R_b located in the cathode circuit of the 6E5. If a single variable resistor (or potentiometer) were used here it could not be turned through its entire range, because minimum bias of about 7.5 volts is needed at all times. The series resistor R_s develops this minimum voltage, thereby making the panel control useful

over its entire range. Variable resistor R_s is screwdriver-adjusted so that minimum bias can be set exactly as required for operation or upon replacement of the 6E5. In practice, it is simpler to use relatively high-resistance potentiometers for R_s and R_b , shunting them with a lower resistance. For this reason, a 15,000-ohm resistor is connected in parallel with the 50,000-ohm potentiometers.

Operating Limits

The sensitivity curves in Fig. 4 and 5 show performance for eye openings of 0 and 10 degrees respectively. The curve for minimum bias and zero angle is difficult to locate accurately, because it shows a barely detectable departure from exact eye closure. A signal any smaller would escape detection. It is not easy to make precise determination of this condition, which means that the accuracy of this limit curve is somewhat doubtful, although it serves to demonstrate that the instrument possesses good absolute sensitivity. Limit curves for eye openings of greater than zero degrees are far easier to determine, and reliance can be placed on their accuracy.

Figure 4 shows input voltages (1,000 cps) for zero-degree eye angle under various combinations of sensitivity and indicator bias control settings. The curve marked MINIMUM BIAS is one limit, and that marked MAXIMUM BIAS is the other limit. By reading vertically from any given sensitivity control setting it is possible to determine the range of signal which will

produce zero-degree eye angle, depending upon the position of the indicator bias control.

Inspection of Fig. 4 shows that the minimum signal which can be detected is 20 μv . With the sensitivity control set at maximum, zero-degree eye opening can be secured with signals up to some 470 μv by proper adjustment of the indicator bias control.

Reference to Fig. 5 indicates that with minimum bias a signal of about 95 μv will produce a ten-degree eye opening, while with maximum bias this opening is produced by a signal of some 510 μv . By varying the amount of bias a ten-degree opening will result from the application of any signal between these limits.

All of the sensitivity data shown in Fig. 4 and 5 relates to absolute sensitivity. The incremental sensitivity is also important, and can be secured by use of these curves. Take, for instance, the case of maximum sensitivity and maximum bias. Figure 4 shows that 470 μv causes zero-degree opening, while Fig. 5 indicates that a signal of 510 μv produces a ten-degree opening. This means that an increment of 40 μv below an initial 510 μv , or some 8 percent change, is required to actuate the indicator over the optical range from ten to zero degrees. For precise work the maximum angle should not exceed ten degrees, and should preferably be nearer five degrees. If this angle is used the voltage increment is cut approximately in half.

Conclusion

Actual use of the instrument has proved that both the absolute and incremental sensitivity are as great as needed at any time. Under average conditions it is necessary to turn the sensitivity control down a bit in order to avoid very touchy bridge controls. Since the instrument contains no moving parts whatever, it is mechanically and electrically rugged, and cannot be damaged by mechanical shock or vibration or by electrical overload. Its operation is little affected by vibration, unlike the vibration-type a-c galvanometer, and stray fields of considerable magnitude do not influence it.

Reduction of HETERODYNE

REDUCTION of constant-frequency interference such as is caused by heterodyne signals can be accomplished by utilizing the principle that heterodyne waves both amplitude and phase modulate the carrier of the desired signal. This method of interference reduction involves simultaneous detection of amplitude and quadrature modulation components of an interfering wave and subsequent canceling of the two detected outputs by balancing them against each other. The reception of desired signals, which are modulated in only one manner, remains unaffected.

The system is of particular advantage for communications in crowded bands where interference due to carrier heterodynes is objectionable, and increases the number of stations that can occupy a given frequency band without producing cross interference. In operation, the system to be described has attenuated strong interference heterodyne signals to below audibility with no apparent effect on the desired signal.

Principle of System

It is an accepted fact¹ that the sum of two waves is a wave which varies in both amplitude and phase. If one of the waves is taken as a reference, the second wave can be said to produce amplitude and phase modulation of this reference wave. In Fig. 1 let e_0 be the reference wave, which may be the carrier wave of a desired signal, and let e_1 be the second wave, which may be an interfering and undesired signal. The combination of these waves can be resolved into a component e_2 which is in phase with the reference wave and produces pure amplitude modulation and a component e_3 which is in phase

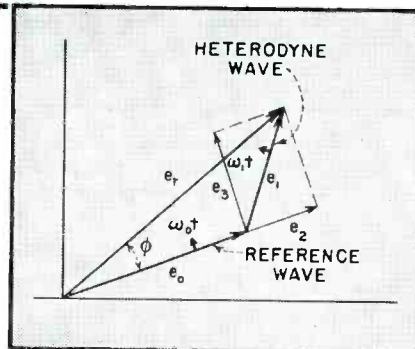

FIG. 1—Vector relations of two waves show phase and amplitude modulation of one by the other

quadrature and produces pure phase modulation.

A heterodyne interference wave thus produces effects which differ from either those of a pure amplitude-modulated wave in which the resultant modulating vector is always exactly in phase with the carrier, or those of a narrow-band phase or frequency-modulated wave in which the resultant modulating vector may be in phase quadrature with the carrier.

The inherent characteristic of a heterodyne interference wave can be utilized to eliminate the interfering effects of the undesired wave in the reception of amplitude-modulated, or narrow-band phase or frequency-modulated signals, provided that suitable detection circuits as assumed in Fig. 2 can be devised. These detectors must be such that the amplitude-modulation detector responds only to sidebands which are in phase with a carrier, and the phase-modulation detector responds only to sidebands which are in phase quadrature with the carrier.

Principle of Detectors

Detectors devised by Crosby,² in which carrier segregation and amplification are utilized, are adaptable for this purpose. Referring to Fig. 3, the carrier, which has been derived from the desired signal by filtering or other means

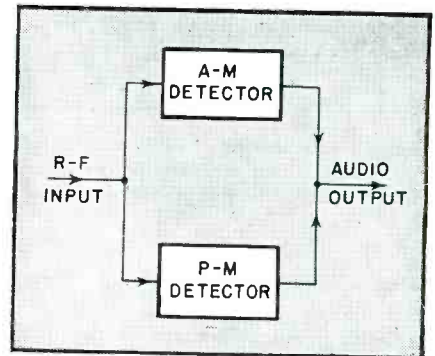

FIG. 2—System by which amplitude and phase, modulation components are independently detected

and then amplified, is applied to the balanced detector as shown. Also the entire received signal is applied in a balanced manner to the rectifiers.

In the absence of the carrier, there is no detection of the received signals, and in the presence of the carrier, only those resultant signal vectors which have components directly in phase or 180 degrees out of phase with the carrier are detected. For the a-m detector the segregated and amplified carrier should be in phase with the signal carrier, while for the p-m detector the segregated carrier should be in phase quadrature.

Basic Circuit

A more complete diagram of the system is shown in Fig. 4. The receiver i-f voltage is fed in parallel to a crystal filter for segregation of the signal carrier, and to two detectors through isolating amplifiers. The segregated carrier from the filter is amplified and fed to the two detectors, with the carrier voltage to one detector being shifted 90 degrees in phase.

One of the detectors detects amplitude modulation and the other detects quadrature modulation. For equal applied voltages, the outputs of the amplitude and quadrature detectors are equal. Thus, in the simultaneous reception, for example, of a pure a-m

INTERFERENCE

Adjacent-channel signals produce both amplitude and phase modulation of the desired carrier. From separate detection of these two modulations, two interference signals are obtained which cancel each other leaving only the desired signal

By H. W. BELLES
Special Research Associate
Harvard University
Cambridge, Mass.

wave and a heterodyne interference wave, the amplitude-modulation detector will respond to both the a-m signal and to the hetero-

dyne signal, while the quadrature detector will respond only to the heterodyne signal. Consequently if the output of the quadrature detector is combined in the proper phase with the output of the amplitude-modulation detector, cancellation of the detected heterodyne signal will result. The output of the quadrature detector must be shifted an additional 90 degrees to bring its output signal into opposition to the heterodyne signal from the other detector. Also the output of the quadrature detector must be shifted an additional 180 degrees when the heterodyne interference

wave changes frequency from above to below that of the carrier.

Effect of Segregated Carrier

Detecting systems, other than that described, are also usable. For example, a single diode to which the segregated carrier and received signal are applied will detect substantially only those signal components in phase with the segregated carrier, provided that the voltage of the segregated carrier greatly exceeds that of the total signal.

It is interesting to note the effects of the large phase shifts which occur in the crystal filter when the incoming carrier is slightly off resonance. One such effect causes detection of amplitude-modulated signals by the phase-modulation detector, because if the carrier is not at exactly 90 degrees phase difference with the amplitude-modulation components some detection of these components will result. This effect of carrier phase shift can be overcome by biasing the detectors so that the segregated carrier voltage will exceed the bias voltage only when the phase shift in the crystal filter is less than a predetermined amount which should be less than 45 degrees, at which condition the outputs from the two detectors are equal.

REFERENCES

- (1) H. J. Reich, "Theory and Application of Electron Tubes" McGraw-Hill Book Co., New York, 1944, (2nd Ed.), p. 314.
- (2) M. G. Crosby, "Communication by Phase Modulation," *Proc. I.R.E.*, 27, p. 126, Feb., 1939.

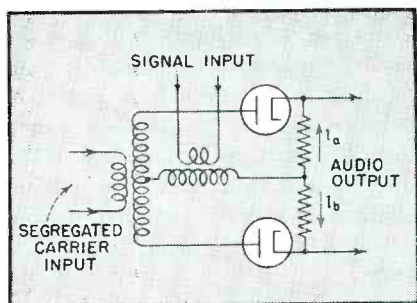

FIG. 3—Balanced rectifier is used to detect either a-m or p-m components of input, but not both

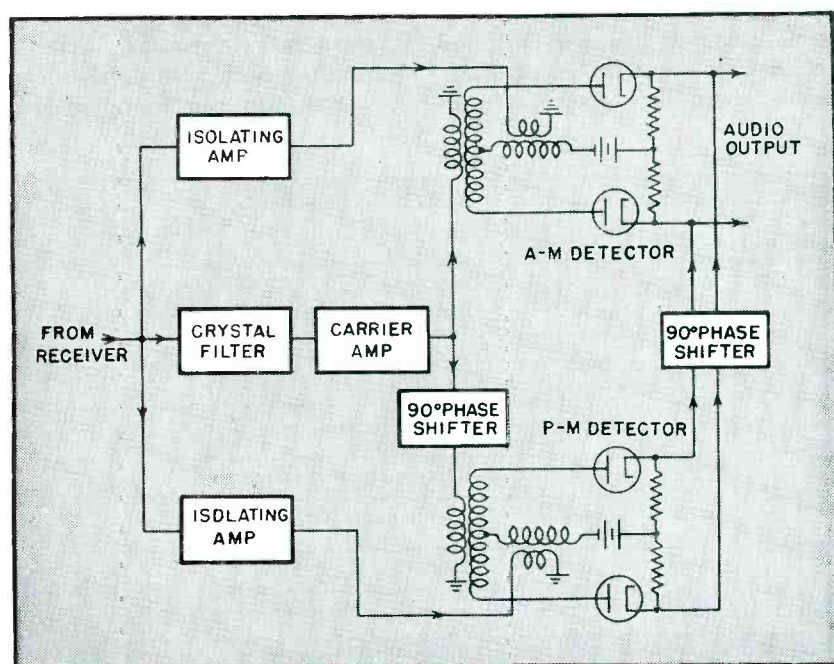
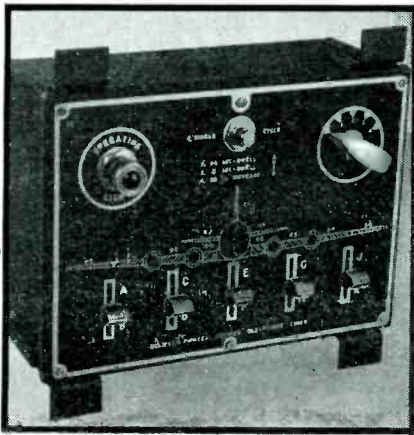

FIG. 4—By means of filters and phase shifters, the interfering carrier heterodyne can be eliminated in the detector stage, leaving only the desired signal



Eclipse-Pioneer electronic timer as built for use on four-engine aircraft. Cross-section drawing of plane indicates positions of de-icer boots controlled by the emergency manual toggle switches at bottom of control panel

automatically followed in sequence at intervals of approximately 40 seconds, other than to manually switch the de-icers on and off. If the rate of ice accretion was only moderate, the amount of ice built up between the first and second cycle was inadequate to afford good removal. Furthermore, if inflation was premature the ice deposit on the boots might become crazed and compromise the proper subsequent removal of ice.

The requirement, then, is for some controlled means of automatically closing switches in sequence at the most effective times for de-icing. The purpose of closing these switches is to complete a circuit to one or more distributor-valve solenoids, to control the opening of poppet valves and release a surge of pressure directly into the de-icer boot cells. These cells immediately punch out to a full inflation. The cells are deflated under their own pressure by unloading to atmosphere upon breaking the solenoid circuit through the timer. Suction accelerates the final stages of boot deflation.

For slushy ice, the rapidity of inflation is very important. With some types of de-icer systems, the inflation of boots is sluggish and as a result the ice sometimes has time to mold itself to the changing contour of the de-icer surface.

For very hard types of ice, the completeness of inflation and the resulting distortion of the rubber surfaces become more important than the rapidity of change. In the

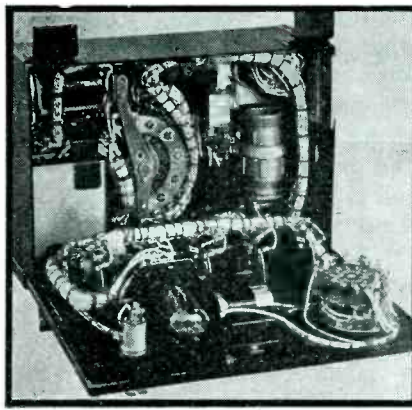

Timer may be opened from the front and allowed to operate, for convenience in making adjustments or locating troubles. Selector switch (at lower right in this view) provides choice of four types of de-icer operation

older systems completeness of inflation on the larger-capacity de-icer boots could only be satisfactorily obtained by recourse to oversize air pumps, with an attendant weight penalty.

Electronic De-Icer Timer

The electronic de-icer timer to be described provides the needed flexible control of de-icer recycling when used with the manifold-solenoid de-icer system. This system replaces the central distributor and multiple tubing lines with pressure and suction manifolds acting in effect as reservoirs of both pressurized and evacuated air for the individual solenoid-controlled distributing valves located at the respective de-icer boot connections. The system not only simplifies the plumbing installation but also improves the rate of inflation and deflation of the de-icer tubes, and adds snap to this process by providing quick opening and shutting of valves along with preselection of inflation periods to suit the capacities of the respective boots. It reduces the control of inflations to an electrical circuit operating the solenoids for

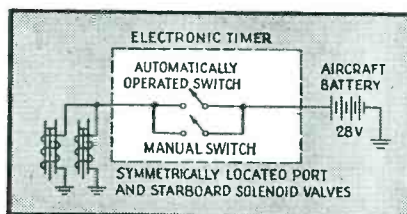

FIG. 2—One of the individual switching circuits controlled by the electronic timer

the most part automatically. Overriding manual controls permit the use of human judgement in anticipating or reacting to rapid changes in icing conditions.

Choice of Operating Cycles

In the latest lightweight system of mechanical de-icing employing the electronic timer mechanism, positive control over all kinds of icing is provided by a choice of four different operating cycles, described below and diagrammed in Fig. 1.

(1) *Single Cycle*, in which the unit inflates each boot in turn once, after the starting button is depressed, and then waits until the starting button is again depressed before proceeding with another inflation cycle. This operation is useful under low-rate icing conditions.

(2) *60-Second Dwell*, in which the unit inflates each boot in turn, waits 60 seconds, then inflates the boot again, waits 60 seconds, etc, until the unit is turned off or switched to another position. This is preferable under medium-rate icing.

(3) *0-Second Dwell*, in which the unit keeps repeating the inflating cycle but does not delay between successive inflation cycles. This obviously provides for high-rate icing.

(4) *50% Increase*, in which the cycling is repetitive without delay between cycles, but the inflation period for each boot is increased by 50 percent. This operation provides for higher altitudes and subnormal air flows from the engine air pump.

Circuit Details

The electronic timer circuit consists of a multiplicity of simple switch circuits plus a combined timing and control circuit. One of the switch circuits is shown in Fig. 2. From five to ten of these circuits are provided, one for each pair of symmetrically located boots required on the aircraft. The automatically-operated switch closes once during each automatic cycle for a predetermined length of time provided for by an electronic timing circuit. The mechanical structure of the automatic switching mechanism is such that the individual circuits can be closed only in a fixed sequence and one at a time.

A schematic diagram of the auto-

matic control circuit appears in Fig. 3. Contacts S_1 , S_2 , S_3 , S_4 , and P_1 (shown with dotted lines) are the contacts of the selector switch on the front panel and the SINGLE-CYCLE starting pushbutton respectively. These provide the four variations in cycling.

Position 11 on the automatic switch has been arbitrarily chosen as the DWELL position of the system, wherein no boots are inflated. In order to provide for SINGLE-CYCLE operation, contacts which are closed at all positions except 11 are connected in series with the stepping circuit, consisting of thyatron tube V_1 and the automatic switch operating coil. These contacts are known as the off-normal contacts, and are shunted by contacts S_1 and P_1 . Since P_1 is normally open and S_1 is open on position 1 of the selector switch, the automatic switch cannot move off position 11 until either P_1 or S_1 closes. As soon as P_1 is pressed, however, the stepping circuit is completed and the automatic switch moves its contact arms to position 1. The off-normal contacts close, and operation continues until position 11 is reached again. In this manner SINGLE-CYCLE operation is obtained. When the selector switch is turned to any of the three automatic positions (2, 3, or 4), contact S_1 continuously shunts the off-normal springs and the automatic switch cannot stop at position 11.

Contact S_2 is closed at all positions except position 2, for 60 SECOND DWELL. When S_2 is closed, only 0.1 megohm is in the discharge circuit of the capacitor, and the time interval is 5×0.1 or 0.5 second. Since this resistor is at position 11 (DWELL) of the automatic switch, the delay between cycles is negligible. When S_2 is open at selector position 2, the resistance of the discharge circuit becomes 12.1 megohms, and the time interval of dwell becomes 5×12.1 or 60.5 sec (values are approximate).

Contact S_3 closes only at selector position 4 and connects a second capacitor in parallel with the one used for all other selector switch positions. This increases the capacitance in the timing circuits by a factor which increases all discharge times 50 percent.

Contact S_4 closes only in the off

position of the selector switch, and when closed shunts tube V_1 . The automatic switch then steps rapidly around to position 11, where the off-normal springs open the circuit, and the automatic switch operating coil is left connected to power. The timer is thus made to reset to the DWELL position no matter what its condition when the unit is turned off.

Stepping Operation

The stepping operation can be broken down into three repeating sequences of the telephone-type rotary switch. Wiper arms are mounted on a shaft, each wiper arm having an associated bank of contacts arranged in a semi-circle with the shaft as a center. When the shaft is rotated, the wipers connect to each contact in their respective banks in turn. There are eleven contacts in each bank, providing for 11 positions in one-half revolution of the wipers. The wipers extend on either side of the shaft, so that two cycles are obtained from one complete revolution. The operating coil, when energized, attracts an armature on the other end of which is a pawl that engages the ratchet wheel. This pawl moves back one tooth on the ratchet wheel when the armature is attracted by energizing the coil. An insulating button on the armature at the same time

opens interrupter springs. When the coil is deenergized, a retractile spring restores the armature and in doing so the pawl drives the ratchet wheel, shaft, and wipers in a clockwise direction through an angle equal to the angular distance between contact centers in the switch bank. Therefore, each time the coil is energized, the switch prepares to step, and each time the coil is deenergized, the switch steps.

First Sequence

For convenience, let the first sequence begin at the instant at which current starts flowing through the coil, but before the resulting pull has overcome the inertia of the armature, corresponding to the conditions of Fig. 4A. At this instant the potential across capacitor C_1 , and consequently the potential difference between grid and cathode of V_1 , is zero and no current flows to or from C_1 . Tube V_1 is passing current through the operating coil and its interrupter contacts, and capacitor C_2 charges with the polarity shown.

Second Sequence

When the coil pulls the armature fully down, the pawl is drawn back one ready for stepping, the interrupter contacts are open and for a short space of time the conditions in Fig. 4B exist. The interrupter contacts

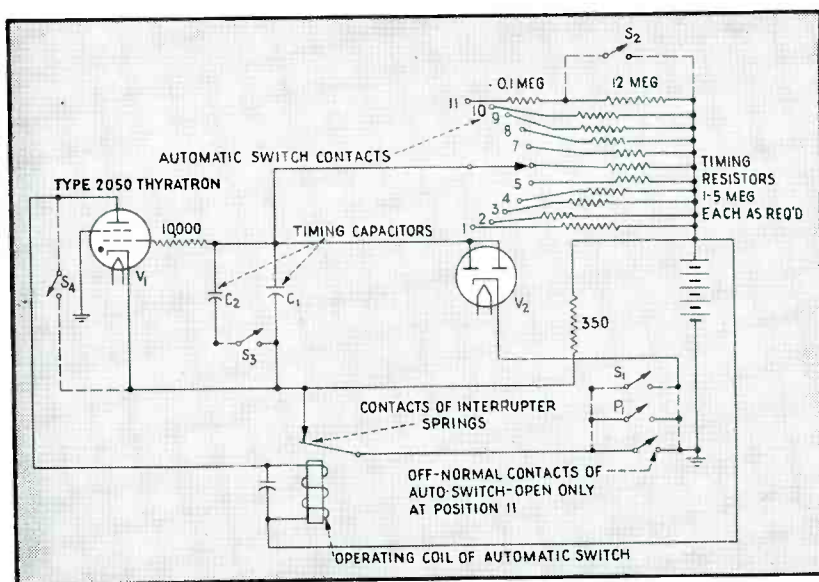

FIG. 3—Automatic control circuit used to operate ten de-icer boots on an aircraft. Stepper arms of automatic switch rest on position 11 during the DWELL interval between cycles. Other contacts (not shown) on the automatic telephone-type stepper switch energize solenoids that control boot inflation

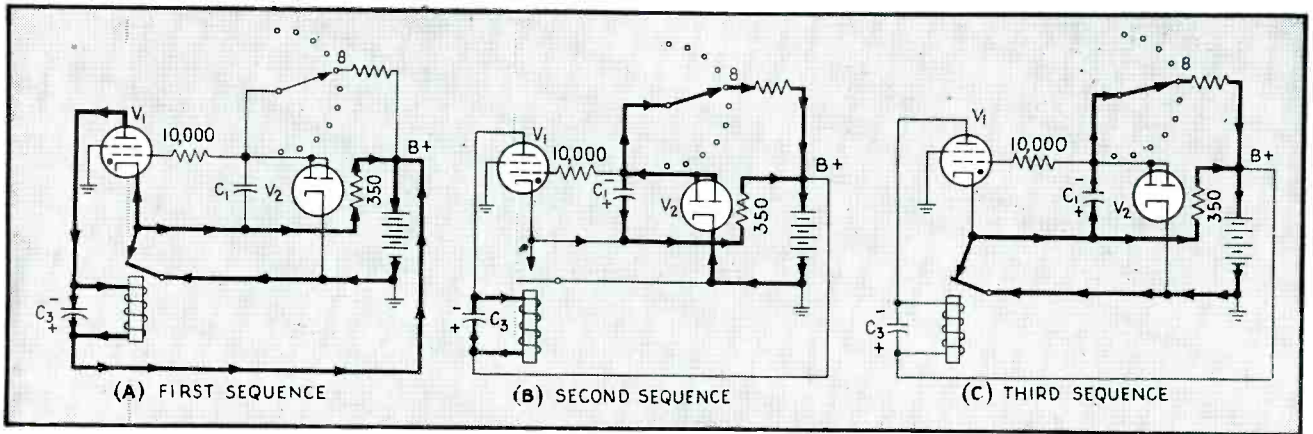

FIG. 4—Simplified versions of automatic control circuit, showing directions of electron flow for the three sequences occurring during a stepping operation associated with the inflation of one de-icer boot. The first and second sequences last approximately 0.05 second each, while the third sequence lasts for the duration of boot inflation time

are open, there is no path from the cathode of V_1 to ground, and the cathode is connected to $B+$ through the 350-ohm resistor. This places both plate and cathode of V_1 at the same potential and consequently no current flows in V_1 . A small current flows for a short time between the coil and C_3 , and C_3 discharges. The main current flow at this instant, however, is the charging current that flows from $B+$ through the 350-ohm resistor to the cathode side of C_1 , and from the grid side of C_1 through tube V_2 to ground. Capacitor C_1 therefore charges with the polarity shown.

Third Sequence

At the end of this short interval during which the V_1 circuit is broken, the retractile spring of the automatic switch overcomes inertia and restores the armature to normal. The pawl drives the shaft and wipers to the next position, the interrupter springs close, and the circuit conditions of Fig. 4C exist. No current flows through V_1 and the coil because C_1 is still charged. The positive side of C_1 is connected to ground and the cathode, and the grid of V_1 is negative by the amount of the charge voltage, thus preventing the resumption of current flow in V_1 . The plates of diode V_2 are connected to the grid and the negative side of C_1 , while its cathode is connected to the positive side of C_1 , and therefore no current can flow through V_2 . There is a current path through which the charge on C_1 can leak off, however, formed by the battery and the resistor connected to the particular point on

which the automatic switch wiper is resting. Since battery resistance is negligible, the time of discharge will depend only on the resistor and capacitor values. Discharge times for individual switch points are obtained by using different values of resistor. A flat percentage increase of all discharge times is obtained by adding additional capacitance in parallel with C_1 .

As the charge on C_1 leaks off, the grid of V_1 becomes less and less negative, until finally it becomes approximately at the same potential as the cathode of V_1 . Tube V_1 then passes current which energizes the automatic switch operating coil, and the system is at the condition of Fig. 4A again.

Adjusting Boot Inflation Time

During the discharge period of the timing cycle, the negative side of the capacitor is connected by the timing resistor to the positive side of the battery, thereby doubling the voltage across the capacitor and providing a nearly linear discharge rate over the voltage range to be used.

To facilitate changing the boot inflation times to agree with the requirements of a particular aircraft, the timing resistors are wired inside a standard AN plug connector which is in turn mounted on a receptacle inside the unit.

Contact Arrangements

Considerable effort was expended to reduce the number of contacts to a minimum. The contacts used for connecting to the various boot valves and the contacts that connect and disconnect additional re-

sistors for different types of operation are mandatory. However, in the control and timing circuit, one pair of contacts (the interrupter springs) in conjunction with diode V_2 perform the functions of charging the capacitor, connecting it so that the grid is negative after charging, deionizing thyatron V_1 , and breaking the circuit to the automatic switch coil after energization to cause it to step the wiper arms to the next position. If the diode were omitted, an additional set of contacts would be required to connect the grid side of the capacitor to ground during charging, and these contacts would have to be critically adjusted with respect to the interrupter springs so as not to provide a short-circuit path across the capacitor after charging.

The standard telephone-type automatic switch used in the timer has three banks of contacts, although only two are required for the circuit. By tying all the contacts in one bank to the power supply, connecting two sets of wipers in series, and using the contacts in the second bank to connect to the valves, it was possible to use the standard contacts of the switch to make and break, as well as carry, the three-ampere inductive load of the valve solenoids without appreciable deterioration of contacts over more than two hundred thousand operations. In terms of de-icing time, this is enormous life, and considerable savings are effected in weight and complexity over a system wherein the telephone switch contacts carry, but don't break, the load current.

Compact, rigid assembly of the vhf impedance-measuring unit is essential



VHF IMPEDANCE

AN INSTRUMENT with which to measure impedance in terms of resistance and reactance through the range of frequencies which have been assigned to the commercial f-m and television services is needed. Below this range r-f bridges are satisfactory and above this range slotted-line measurements are convenient.¹

The instrument to be described is small and compact so that it can be used in many places inaccessible with conventional equipment. The grounding problem, which is always important and often critical at these frequencies, offers little difficulty principally because the device is complete in itself.

Description of Method

The range can be quickly varied to suit the particular problem so that in most cases it is unnecessary to supplement the unknown impedance with a known reactance in order to bring the unknown impedance within range of the instrument. However, greatest accuracy is obtainable through the resistance and reactance ranges commonly encountered in antenna and transmission line measurements. The resistance range is approximately 30 to 1000 ohms, and at 100 mc the reactance range is approximately ± 15 to 500 ohms. The reactance range depends on the capacitance

By **D. STANLEY HENRY**

*Don Lee Broadcasting System
Hollywood, Calif.*

range of the capacitor used for C_3 in Fig. 1 and 2.

Resistance measurements are made in terms of a ratio of the voltage developed across a resonant circuit to the voltage resulting when the unknown resistance is introduced into the circuit. The unknown reactance is measured in terms of the variation of reactance of an accurately calibrated capacitor that is required to return the measuring circuit to resonance.²

The most logical means of measuring voltage and indicating resonance is a vacuum tube voltmeter connected to a resonant circuit L_1C_1 as shown in Fig. 1. Because a voltage ratio is used, the voltmeter need not be calibrated if its law of deflection is known. One of the adjustments requires tuning to produce 70.7 percent of the voltage at resonance. This voltage would be one-half of the voltmeter reading at resonance if the voltmeter were square-law. The added sensitivity of this type of voltmeter is convenient for increased tuning accuracy.

A balanced-modulator circuit will insure square-law operation because only second-order terms appear in the plate circuit. A 100- μ a meter with at least 50 dial divisions is satisfactory for the meter. The

required balanced voltage for the voltmeter is obtained from the balanced circuit L_1C_1 .

Assume Q_2 of resonant circuit L_2, C_2, C_3 is reasonably high so that R_2 can be neglected. Let Z_2 be the impedance seen by a series generator in circuit 2 of Fig. 1 when it is isolated from circuit 1, then

$$Z_1 = \frac{Z_R Z_X}{Z_R + Z_X}$$

When circuit 2 is coupled to circuit 1, the impedance appearing in circuit 1 due to circuit 2 is³

$$\frac{(\omega M)^2}{Z_2} = \frac{(\omega M)^2}{Z_R} + \frac{(\omega M)^2}{Z_X}$$

This equation shows that the various shunt impedances affect circuit 1 independently and any one may be added or removed without changing the effect of the others. Regardless of the physical arrangement of the unknown impedance, circuit 2 sees the equivalent resistance in parallel with the equivalent reactance. In cases where the series components are more desirable and useful, the parallel combination can be changed to the series equivalent.

It should be noted that the minimum capacitance of C_3 will appear across C_3 as an unknown reactance but the effect of this reactance is constant and will not modify the value of the unknown because it

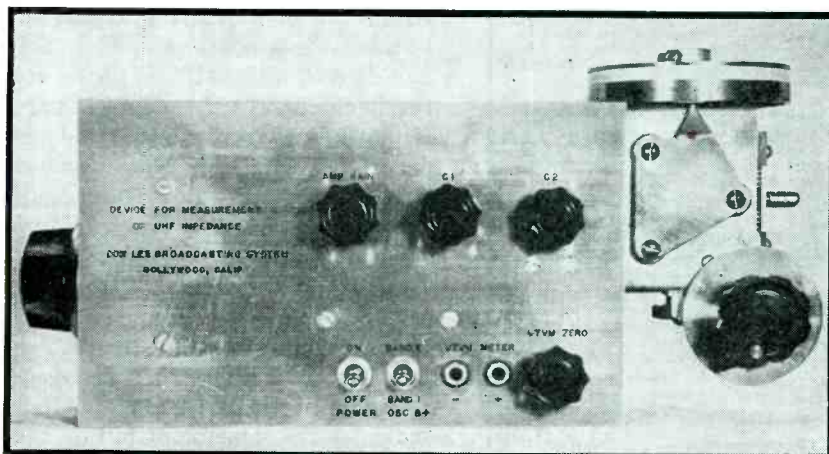

Unknown is connected directly to the calibrated capacitor at the right

MEASUREMENTS

Equipment for making impedance measurements in the range from 50 to 150 mc is described and its probable errors are analyzed. Construction and operation of the equipment and method of making measurements are explained

has been shown that unknown components across C_3 affect circuit 1 independently.

It is important to connect the unknown directly to the terminals of C_3 rather than to electrically equivalent points, to eliminate error which would be introduced by the inductance of the leads connecting circuit 2 to C_3 . The method of tuning circuit 2 described below will show that the circuit inductive reactance is tuned out.

Care must be taken to maintain the Q of circuit 2 as high as possible because the principal assumption in this method of measurement is that the resistance of circuit 2 is negligible. Consideration of this

resistance would make the measurements unnecessarily tedious. Experience has shown that very practical and useful results can be obtained with such an assumption.

The resistance R_1 of circuit 1 is used as a starting point for making measurements but it is not necessary to know the ohmic value. At one point in the tuning procedure, circuit 1 will be detuned from resonance until the square-law voltmeter indicates one-half the reading at resonance. This indicates a voltage 70.7 percent of maximum and shows that a reactance equal to R_1 has been added to circuit 1. This reactance will then be replaced by an equal reactance of opposite sign

which can be accurately determined from C_3 . The constant driving voltage is effectively in series with L_1 and C_1 because this circuit is driven by a pentode which is practically a constant-current generator. The inductive coupling between L_1 and L_2 , which presents resistance and reactance components to circuit 1, need not be known.

Measurement Procedure

In using the vhf impedance measuring circuit of Fig. 2, the following procedure is used:

1. Detune C_1 until it has no effect on the voltmeter and set the voltmeter to zero.
2. Set C_3 to minimum so that $\Delta C_3 = 0$.
3. Tune C_1 for maximum voltmeter reading and adjust the amplifier gain for a convenient reading, probably full scale. Circuit 2 is so far from resonance that it will have negligible effect on circuit 1 at this point.
4. Short C_3 by inserting a strip of crimped copper between the plates. This must be done at the plates rather than across the terminals to avoid the error caused by

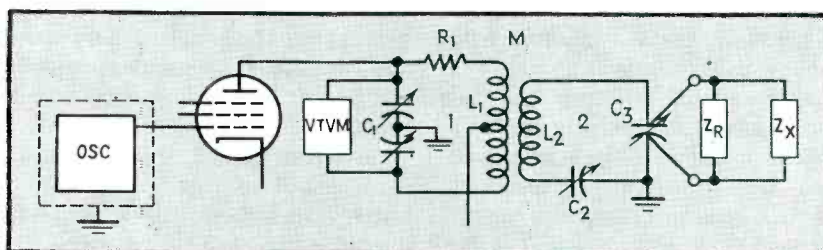

FIG. 1—The principle of measurement is that of a Q meter. The pentode prevents reaction of the measuring circuit on the oscillator and gives the generator a nearly infinite internal impedance

in just the same manner as an error in (ΔC_3) affects the measured value of X . Of course, the errors can tend to cancel or to accumulate, depending on the relative sign of the differential value.

Description of Unit

If the power leads are filtered, no r-f will get to L_1 except through the pentode amplifier which approximates a constant-current generator. A butterfly circuit oscillator is an ideal source of power for such a device because of its range, small size and simplicity.

The upper frequency limit of this particular unit is 150 mc. This limit is determined by the necessary inductance of the leads to C_3 because the terminals of C_3 must be available for connecting the unknown. L_2 must be large enough to couple sufficiently with L_1 .

The square-law vtm is best checked by plotting the square root of the meter deflection as a function of the applied voltage. If the meter response is square-law, this plot gives a straight line.

In use, the balance of the L_1C_1 circuit can be conveniently checked by tuning C_1 to resonance and then touching each stator section of C_1 in succession. The voltmeter read-

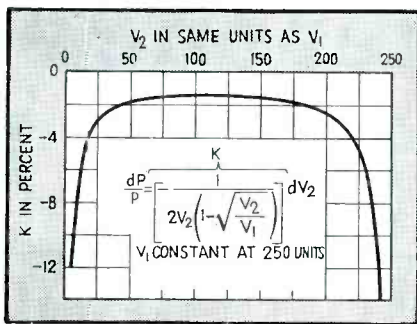

FIG. 3—Adjust coupling between circuits 1 and 2 of Fig. 1 to keep V_2 within the range of least relative error K which can be introduced by inaccuracies in reading voltages when measuring resistances

ing should drop to nearly zero in each case. Small amounts of unbalance can sometimes be compensated by adjusting the center-tap by-pass capacitor. Choice of tubes or of bias operating point is relatively unimportant.

Typical Measurements

In making any measurement, it is comforting to be able to make it by at least two radically different methods. Because the range of this instrument overlaps the upper limit of the General Radio 916-A r-f bridge, a complete comparison of the two methods at 50 mc was

possible. The average difference for random measurements was within five percent and in many cases less than two percent.

Figure 4 shows the results of a group of measurements to determine the characteristic impedance⁵ of a 50-foot length of concentric line. The open-circuit and short-circuit reactances of the line are plotted as a function of frequency without regard to sign.

Figure 5 gives the characteristics of a dipole fed with a length of EO1 cable. As this is a balanced impedance and the instrument is an unbalanced device, the measurement is tedious but the curves indicate the results that can be expected and demonstrate the consistency of the measurements. The value of about 76 ohms resistance at resonance is reasonable.

REFERENCES

- (1) Marchand, N., and Chapman, R., UHF Impedance Measurements, *ELECTRONICS*, p 97, June, 1945.
- (2) Seeley, S. W., and Barden, W. S., A New Method for Measurement of Ultra-High Frequency Impedance; "Radio at Ultra-High Frequencies," *RCA Institutes Technical Press*, 1940, p 272-293.
- (3) Terman, F. E., "Radio Engineer's Handbook," McGraw-Hill Book Co., 1943, p. 149.
- (4) Karplus, Eduard, The Butterfly Circuit, *General Radio Experimenter*, 19, No. 5, Oct. 1944.
- (5) Sinclair, D. B., Measuring Balanced Impedances with the R F Bridge, *General Radio Experimenter*, 17, No. 4, Sept., 1942.

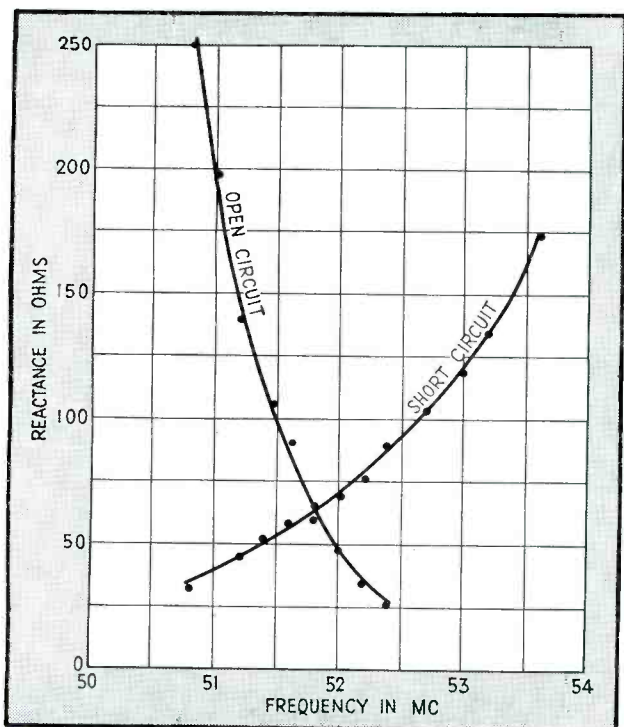

FIG. 4—Measurement of coaxial-line reactance made with the instrument

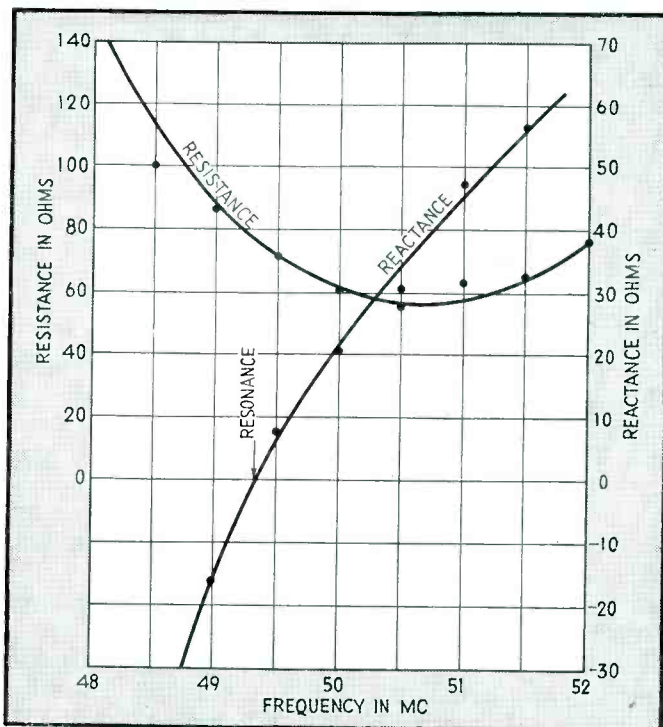

FIG. 5—Impedance of a dipole antenna as measured with the test instrument

Interference-Free WEATHEROMETER

Accelerated weathering is applied to plastic and rubber materials and measured with photoelectric equipment. Automatic cycling of wetting and irradiation is provided and no radio interference is caused. The action is about ten times faster than outdoor exposure

THE weatherometer to be described was developed to furnish accelerated weathering for testing components of aircraft radio equipment. Such tests are made on plastic and rubber material and nameplates. The device simulates the conditions of rain and sunlight and provides two hours of wetting, two hours of irradiation, two more hours of wetting and 18 hours of irradiation as prescribed in Federal and Navy aeronautical specifications. This is continued through 10 cycles or 240 hours.

The weathering conditions are provided by two infrared lamps for heat, ultraviolet lamps for irradiation, and a sprinkler for wetting. Three sunlight lamps were used for the ultraviolet source because a flaming arc was found to cause radio interference. The likely changes in the physical condition of the samples after testing are crazing, discoloration, blooming, and warping.

Weathering Equipment

The complete unit is shown in Fig. 1. The lamps are mounted in an aluminum reflector the length of the cabinet, with each infrared lamp between two sunlight lamps. The sprinkler is a brass pipe perforated with small holes and operated by a solenoid-type valve.

A wire rack is fitted inside the cabinet so that the sample material is centered at a vertex point where water spray, light rays, and air current from a blower meet.

Photoelectric equipment was constructed for measurement of the degree of weathering. In this, the light source is a six-volt automobile-type bulb mounted in front of a reflector and lighted from a storage

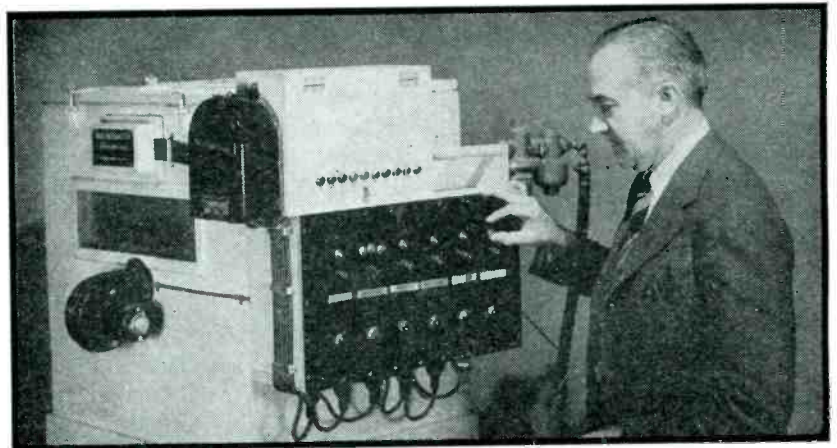

FIG. 1—Interference-free weatherometer for accelerated weathering tests of components

battery. A Weston Photronic cell with a Viscor filter is connected to an ammeter with a 100- μ a range. A variable resistor is used to adjust the light intensity.

The light-source is mounted behind a partition equipped with a one-inch circular aperture in one end of the box. In the other end of the box and 18 inches away is a similar partition equipped with a one-inch aperture in front of the cell.

Calibration

For test samples, strips of cellulose nitrate material 0.125 inch in thickness were subjected to the weathering cycle and outdoor exposure. The amount of discoloration was measured on exposed samples each day by light transmission methods.

The test samples were cleaned of dust and grease and measured by placing in front of the aperture at the cell. The cell receives the undeviated fraction of the light and part of the scattered light which is not deflected at angles greater than

about 90 degrees. The total light transmission of the test sample is the fraction of the original light received by the cell which continues to reach the sensitive element. When the reading taken without the test sample is 100 μ a, the reading taken with the sample in front of the Photronic cell aperture gives the percentage of total light transmitted.

Manual Controls

On the black Bakelite panel shown in Fig. 1 are eight toggle switches. The switch on the left side of the panel operates the blower, and the cluster of three switches controls the three sunlight lamps. A choice of one, two, or three sunlight lamps can be had. The next two switches to the right control the infrared lamps. Another switch operates the solenoid valve for the sprinkler.

The heart of the automatic control is the rotary selector switch shown in Fig. 2. This was obtained from a pin-ball machine and has 36 contacts of which 25 are used. This

By W. B. RITCHIE AGNEW

Chemical Engineer
Aircraft Radio Laboratories
Wright Field, Dayton, Ohio

selector switch (A in the circuit of Fig. 3) is operated by two solenoid magnets, one magnet operating a ratchet-wheel and the other solenoid controlling the kick-back.

Weather Sequence

A cardboard dial is fastened to the shaft of this switch and is numbered from 1 to 24, denoting hours. The first two segments are also marked RAIN, the next two are marked SUNSHINE, the fifth and sixth contacts are marked RAIN and the remaining 18 are marked SUNSHINE. The 25th contact operates the kick-back solenoid which releases the ratchet and allows a spring to return the ratchet-wheel to its starting position. At the same time, the electromagnet in another selector switch of the telephone type (B in Fig. 3) which is mounted on the lid of the automatic control is energized.

To start the automatic cycling device, the switch on the extreme right of the manual control panel is

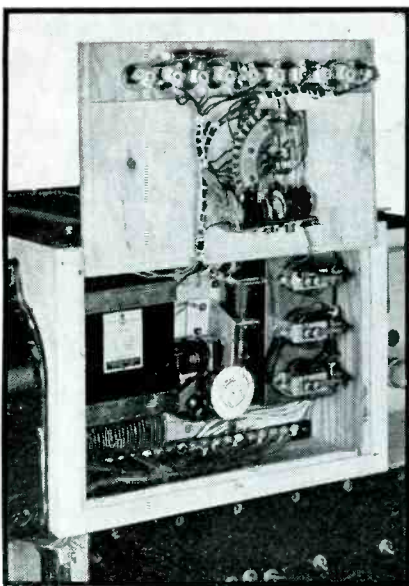

FIG. 2—The control panel of the weatherometer contains switches, fuses, and pilot lights. The rotary selector switch came from a pin-ball machine

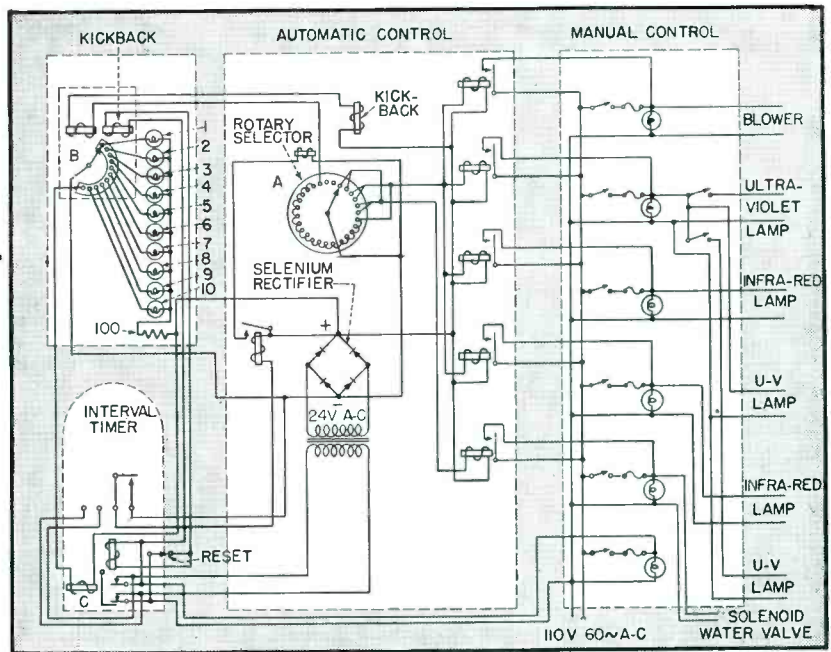

FIG. 3—Relay and switching circuits of the weatherometer

operated. With all switches in their off positions, the automatic control switch starts the Telechron clock of the interval timer.

A pushbutton in the interval timer is used for a momentary impulse to lock relay C into place. With this relay locked and the automatic control switch on, the clock runs. The dial on the shaft is divided into 60 segments denoting minutes. A glance at the two dials shows the number of hours and minutes of any 24-hour cycle.

The relay which closes the circuit between the contacts of the solenoid valve switch is closed due to the position of selector switch A which is on its number 1 contact. Number 1 panel lamp of the ten shown on the front of the automatic cycling device is lighted denoting the first 24-hour cycle or day. Now at a glance we can add days to our computation of time of weathering or calculate the time necessary to finish the required 10 cycles of 24 hours. At the end of the 10th cycle, the selector switch B makes the 11th contact which energizes the electromagnet which unlocks relay C. This opens the a-c input and completely shuts the weatherometer down.

Interval Timer

The interval timer makes a momentary contact of its built-in switch every hour. This impulse energizes the solenoid magnet of

the rotary selector switch and, at the end of the first hour, the energized solenoid moves the ratchet-wheel contact to the second contact. This contact also connects to the solenoid-valve relay, and consequently the rain part of the cycle remains on.

At the next impulse from the interval timer, the selector switch moves up another contact; this breaks the solenoid-valve circuit and cuts in the relays controlling the blower, sunlight lamps and both infrared lamps. The weatherometer is now on the sunshine part of the weathering cycle. The interval timer continues to operate the selector switch through its controlling relay every hour of the 24-hour cycle.

When the 25th contact is made, the kick-back solenoid of the rotary switch A returns it to contact number 1 to begin the second cycle. This 25th contact also energizes the ratchet-wheel magnet of selector switch B and moves the switch arm to contact number 2, turning off the first light of the 10 denoting the number of cycles or days and turning on panel light number 2. This indicates that the first 24-hour cycle is completed and the second cycle is starting.

The acceleration factor of the interference-free weatherometer was found to be between 10 and 11 times greater than results obtained from outdoor exposure.

Vectorial Treatment of TRANSMISSION LINES

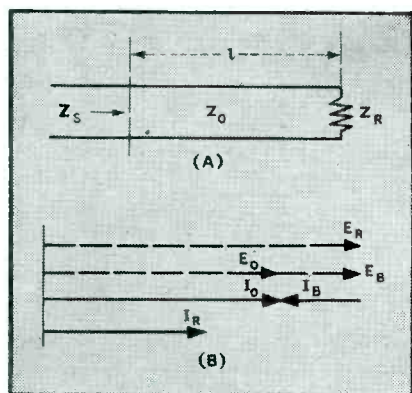

FIG. 1—(A) Transmission line showing relation of point, surge, and load impedances, and (B) currents and voltages at load for a load of $2Z_0$.

By J. P. SHANKLIN

Assistant Project Engineer, Bendix Radio
Division of Bendix Aviation Corp.
Baltimore, Md.

MOST TRANSMISSION LINE problems can be solved by vectors. The use of vectors makes the action of the line clear and allows visualizations which would otherwise be difficult.

Conditions at Load

Standing waves on a transmission line are caused by two waves, the incident and the reflected waves, traveling in opposite directions. At certain points the two voltages add and at certain other points they subtract. In Fig. 1A let $Z_R = 2Z_0/0^\circ$. A 2:1 standing wave ratio will be caused by the mismatch, the maximum value of which will be $E_0 + E_B$ and the minimum value $E_0 - E_B$ and $E_0 + E_B = 2(E_0 - E_B)$ or

$$E_0/E_B = 3 \quad (1)$$

where the symbols are as defined in Table I.

The load is resistive and higher than the line impedance, therefore there is a high of the standing wave at the load or

$$E_R = E_0 + E_B \quad (2)$$

The voltage vectors of Fig. 1B may

be drawn from Eq. (1) and (2). As to the currents involved, the incident current I_0 is considered to be in phase with the incident voltage E_0 but the reflected current I_B is considered to be 180° out of phase with the reflected voltage E_B . This is because of the sense of direction of flow which has been chosen.

The reflected wave may be considered as negative power because it is returning to the generator. The voltages are considered to have the same direction sense because both are measured across the line. A scale for the currents is chosen which will make the vectors I_0 equal E_0 and I_B equal E_B in length. The ratio of the scales used for voltage

and current is dependent on the line surge impedance Z_0 according to the relation

$$\text{Scale Ratio} = Z_0 = E_0/I_0 = E_B/I_B \quad (3)$$

Conditions Away From Load

Figure 2A is a vector diagram of the line voltages and currents for the same load as in Fig. 1 but where l equals 45 electrical degrees of line.

A single vector is used to represent E_0 and I_0 . This vector is advanced 45° (counterclockwise) from the position of E_0 and I_0 in Fig. 1B because the incident wave will reach this point earlier. The vector E_B is drawn from the terminal of vector E_0 , I_0 and retarded (clockwise) 45° since the reflected wave

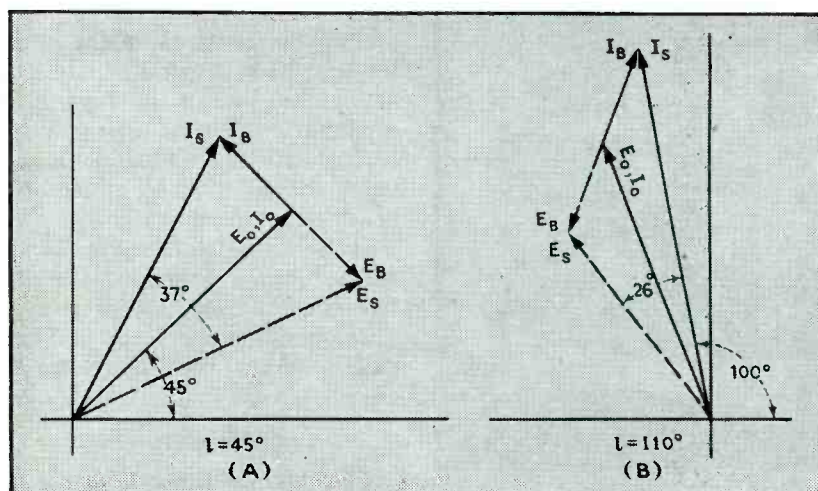
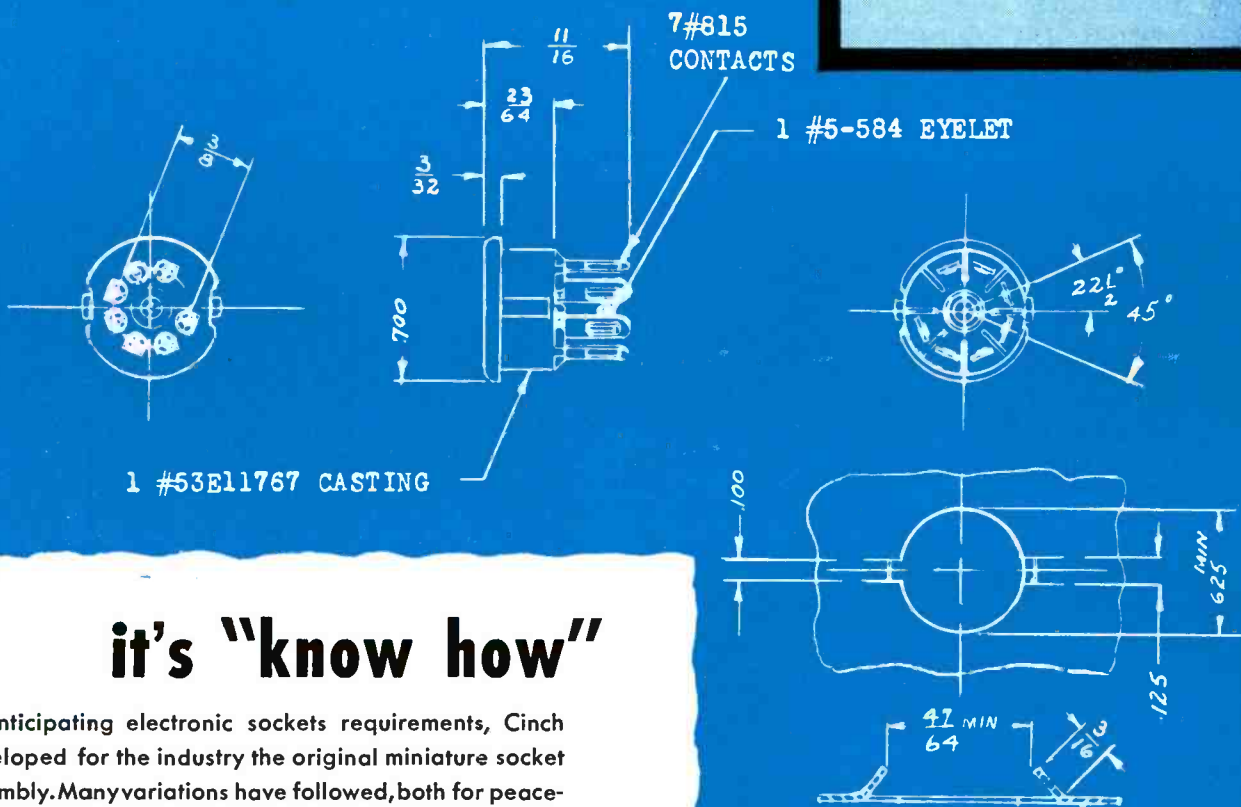

FIG. 2—Current and voltage relations for a line terminated in a resistance of $2Z_0$, (A) 45 electrical degrees from the load, and (B) 110 electrical degrees from the load

Miniature Chassis-Clinch Sockets.



it's "know how"

● Anticipating electronic sockets requirements, Cinch developed for the industry the original miniature socket assembly. Many variations have followed, both for peacetime and for war purposes. And now the new miniature chassis clinch socket is meeting the universal satisfaction expected of its design and construction, a product of our knowledge of your socket problems. Illustrated here is complete engineering data. Samples, tools, and a visit by our field engineers are at your service on request.

USE PUNCH #PD-204 TO PERFORATE SHEAR AND FORM EARS IN CHASSIS
USE CLINCHING TOOL #PD-205 FOR THIS SOCKET

CINCH MANUFACTURING CORPORATION

2335 W. Van Buren Street, Chicago 12, Illinois
Subsidiary of United-Carr Fastener Corp., Cambridge 42, Mass.



● The NEW CINCH catalog, 140 pages describing metal parts and metal plastic assemblies.

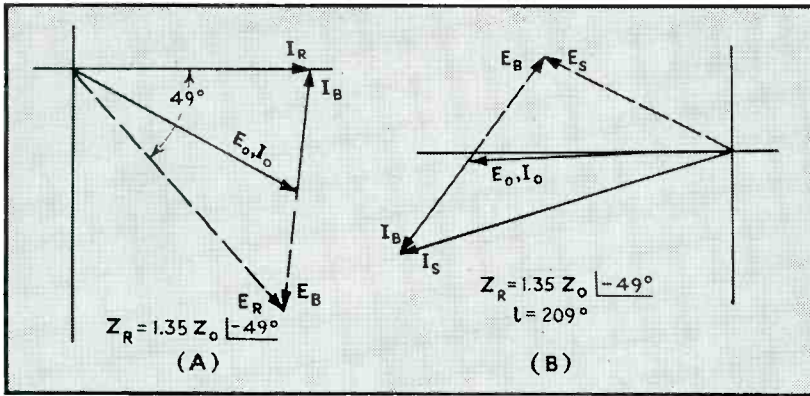

FIG. 3—Vectorial representations of conditions at a complex load (A), and some distance from it (B)

reaches this point later.

The vector sum of E_0 and E_R results in the line voltage vector E_S . The vector I_B is drawn as before, 180° out of phase with E_R . The vector sum of I_0 and I_B results in the line current vector I_S . This diagram reveals that

$$Z_S = E_S / I_S = Z_0 \angle -37^\circ$$

and also that the phase angle of E_S and I_S relative to E_R and I_B can be measured.

Figure 2B is the vector diagram when l is 110° and yields the following data

$$Z_S = 0.608 Z / 26^\circ$$

I_S is 100° ahead of load current I_R . E_S is 126° ahead of load voltage E_R .

Figure 3A is the vector diagram at a complex load $1.35 Z_0 \angle -49^\circ$.

First the vectors I_R and E_R are drawn, making E_R equal $1.35 I_R$ and current leading 49° . I_R has been taken on the zero or reference axis although this is immaterial.

Connect the terminals of I_R and E_R and plot a point in the center of this line. This point is the terminal of the E_0, I_0 vector. I_R can be seen to be the vector sum of I_0 and I_B , and E_R the vector sum of E_0 and E_B . The E_0, I_0 and E_B, I_B vectors have now been determined so that the vector diagram for any point on the line may be drawn.

Figure 3B is the vector diagram 209° away from the load. The E_0, I_0 vector has been rotated 209° counterclockwise from its position in Fig. 3A and E_B and I_B have been rotated clockwise 209° from their positions in Fig. 3A.

Antenna Feeding

A problem sometimes encountered in a high-frequency array is to feed three dipoles in phase, the center dipole to be fed 1.5 times the current of the outer dipoles. This problem is similar to that of feeding the towers of a broadcast transmitter at the necessary current amplitudes and phases to develop a required radiation pattern.

The feeding system is shown in Fig. 4A. Because the end antennas were similar, they were combined reducing the circuit to that of Fig. 4B and impedances expressed in terms of the feed line impedances. Fig. 4C is the vector diagram at the Z_1 load and Fig. 3A the vector diagram at the Z_2 load. Note that the two load current vectors are drawn to satisfy the antenna requirements. That is, they are in phase, and the length of I_B Fig. 4C

is scaled two units representing current in both end dipoles, and I_R of Fig. 3A is scaled 1.5 units.

There are three requirements to be met: (1) dipole currents must be in phase, (2) dipole currents must be in a 1.5 to 1 amplitude ratio, and (3) a resistive 50-ohm load must be presented to the 50-ohm line. Using the two variables l_1 and l_2 it is probable that any two of these requirements can be satisfied. The first two have been chosen because they must be satisfied before the lines are joined. The loads must

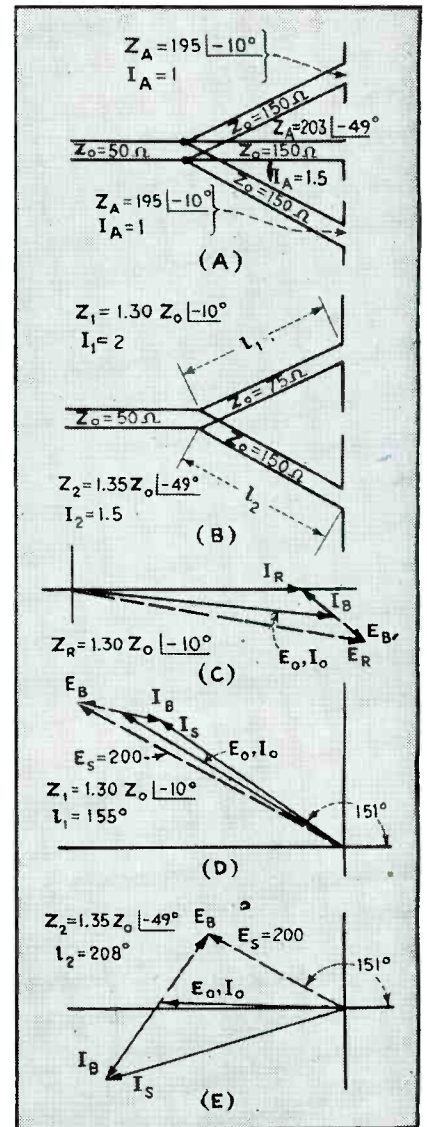

FIG. 4—Determination of feeding condition for a three-element array can be made vectorially. The given conditions are shown at (A), which can be simplified to (B) from which vectors at the upper antenna can be plotted (C). Vectors for the lower equivalent antenna are as at (A) in Fig. 3. The angular distance at which voltages on antenna feed lines are in phase is determined from (D) and (E)

TABLE I
DEFINITION OF SYMBOLS USED IN THE TEXT

E_0, I_0	Incident voltage and current at the load
E_R, I_R	Voltage and current across load Z_R
E_B, I_B	Voltage and current reflected by the load
E_S, I_S	Voltage and current a distance l from the load toward the generator
Z_0	Surge impedance of the transmission line
Z_R	Impedance of the terminating load
Z_S	Impedance at a point on the transmission line
l	Distance along transmission line measured in electrical degrees from the load toward the generator
For other symbols used in text, see circuit diagrams	

MALLORY CONTACT ASSEMBLIES

Must Pass X-Ray Inspections

THERE'S no guesswork about the bond between contact facings and backings manufactured by Mallory. Contact assemblies and contacts are checked with this 250,000-volt X-ray machine . . . and both the bond and structure of the metals bonded must pass a searching inspection.

Grueling life tests under the toughest operating conditions . . . precise control of every metallurgical factor . . . these are other reasons why Mallory Contacts and Contact Assemblies are noted for their dependable performance, long life and ability to withstand electrical overloads.

Mallory research has developed many new contact alloys and powdered metals. Mallory manufacturing "know-how" has produced millions of contacts and contact assemblies of uniformly high quality. Mallory design engineers have helped many industries . . . producing relays, industrial controls, circuit breakers, business machines, domestic appliances and other products . . . to specify or design the right contact or assembly *before* blueprints have left the drafting board. Thus Mallory has become Contact Headquarters.

*Reg. U. S. Pat. Off. for electric contacting elements.

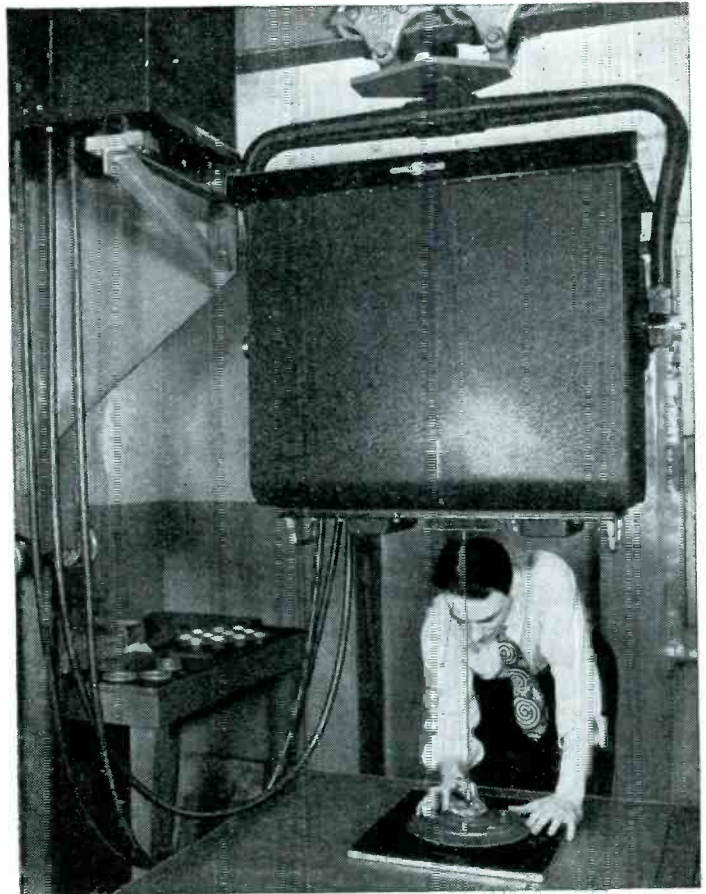

X-ray inspection assures the quality of Mallory Contacts and Contact Assemblies made of silver, platinum, Elkonite, Elkonium* and Tungsten.*

Whether you need complete contact assemblies, individual contacts, or the assembly of contacts to your own brackets, studs, springs or arms, consult Mallory on your specific problem. Write us today if you'd like samples to test in your applications.

Write today for your copy of the Mallory contact catalog. The New Mallory Contact Data Book will be sent gratis to engineers when requested on company letterhead. Available to students, libraries and schools at \$2.50 per copy, postage paid.

P. R. MALLORY & CO., Inc., Indianapolis 6, Indiana



P. R. MALLORY & CO. Inc.
MALLORY

ELECTRICAL CONTACTS AND CONTACT ASSEMBLIES

give enough reflection to cause sufficient impedance variations along the lines to make a solution possible.

It is then necessary, by drawing trial vector diagrams for different lengths of l_1 and l_2 , to find the lengths which will fill the first two requirements. Because the loads do not greatly mismatch their lines, lengths near even $\lambda/2$ multiples were tried in hopes of also partially satisfying requirement (3). Also, it is apparent that l_2 must be longer than l_1 because the current in Z_2 is to lead the current in Z_1 by 39° and must therefore be retarded.

Figure 4D is the solution. In order to connect the two lines together their voltages must be equal and in phase. The apparent difference in amplitude of the E_s voltages in Fig. 4D and E is due to 2:1 ratio of scales used for the 150 and 75-ohm lines. The current scales, however, are equal.

Impedance Matching

Figure 5 is the vector diagram of the input currents and voltage at the juncture of l_1 and l_2 . The currents I_1 and I_2 in the two lines are added vectorially to give the 50-ohm line current I_s . The E_s vector is the same vector as E_s of Fig. 4D and 4E except that the voltage scale has been changed to conform to a 50-ohm line. The input impedance of $1.1 Z_0 / -21.5^\circ$ would be considered satisfactory for most high-frequency work.

The impedance 55 ohms $/-21.5^\circ$ may be matched to the 50-ohm line by the short-stub corrector shown in Fig. 6A. First draw the vector diagram of Fig. 6B at the load. As I_R is leading E_R an inductive or lagging current will be needed to bring

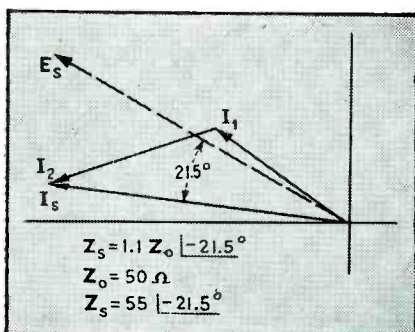

FIG. 5—At the juncture of the feed lines of Fig. 4B the voltages and currents have this relation as determined from Fig. 4D and 4E

them into phase. Also, the length of the I_s vector must equal the E_s vector to represent a 50-ohm load.

Next draw the diagram of Fig. 6C. Draw the E_o, I_o vector of Fig. 6B at any angle (180° in Fig. 6C). From the terminal of E_o, I_o strike an arc of radius equal to E_R . Draw the vectors E_s and E_B , making the angle between them 90° . Draw I_B and I_s . I_o will then represent the inductive current to be drawn by the correcting stub. Note that it lags 90° behind the voltage E_s across the stub.

The 50-ohm line current I_{50} is the vector sum of I_o and the input current I_s to line l_1 . The angle between E_o and E_B in Fig. 6B is 105.5° and the angle between E_o and E_B in Fig. 6C is 79° . The difference of 26.5° is caused by their rotation in traveling over the length of line l_1 . The electrical length of l_1 will be half this amount or 13.25° because the vectors rotate in opposite directions. If desired, Fig. 6C may be redrawn in proper angular reference to the preceding diagrams. This results in Fig. 6D which is the input diagram for $Z_R = 1.1 Z_0 / -21.5^\circ$ and $l_1 = 13.25^\circ$.

Figure 6C could have been drawn by calculating the magnitude of E_s first, and drawing E_B at right angles to E_s . The total power on the line will be the same at all points, therefore in Fig. 6B $P = E_R I_R \cos 21.5^\circ$, or scaling E_R and I_R , $P = 200 \times 3.6 \times 0.930 = 670$. In Fig. 6C, $P = E_s^2 / Z_0$ or $670 = E_s^2 / 50$, thus $E_s = 183$.

Stub Length

In determining the length of the stub l_2 of Fig. 6A, first consider the characteristics of a shorted line. There will be 100 percent reflection at the short, therefore E_B will equal E_o and I_B will equal I_o . There can be no voltage across the short, therefore E_B must be 180° out of phase with E_o at the short. Since the voltages are 180° out of phase, the currents I_o and I_B must be in phase and adding. A vector diagram could be drawn representing these conditions at the short.

Now draw Fig. 6E, the vector diagram for the input to the stub. I_o and E_s are copied from Fig. 6D. E_o and E_B are 45° out of phase in Fig. 6E and were 180° out of phase at the short. Since E_o turns count-

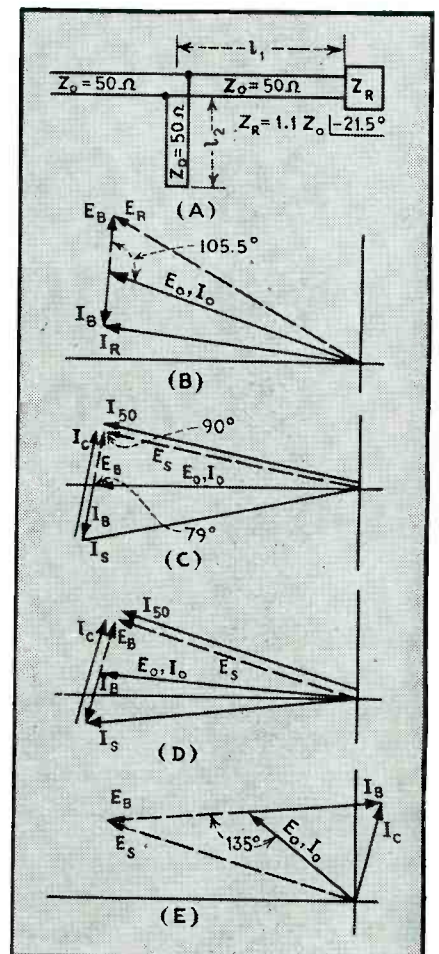

FIG. 6—To match the transmission and feed lines, a shorted stub (A) is required. Conditions at the load are shown at (B), and the inductive current to be drawn by the stub is determined from (C). (D) is (C) reoriented to agree with previous vector positions. (E) represents the input to the stub from which stub length is determined

erclockwise and E_B clockwise, to have reached their position in Fig. 6E they must have moved in relation to each other by the larger angle between them, or 135° . Therefore l_2 of Fig. 6A must then be half this long or 67.5° .

Lines With Loss

So far only lossless lines have been considered. Transmission line problems involving lines having loss are complicated when handled by formulas, but the use of vectors simplifies this type of problem.

Because a transmission line is linear, the percentage loss to the incident wave will equal the percentage loss to the reflected wave. If the input and output powers are known or can be measured, the line loss can be determined, and apportioned for any length line.



250 AND 1000 WATT FM BROADCAST TRANSMITTERS ARE *On The Way...*

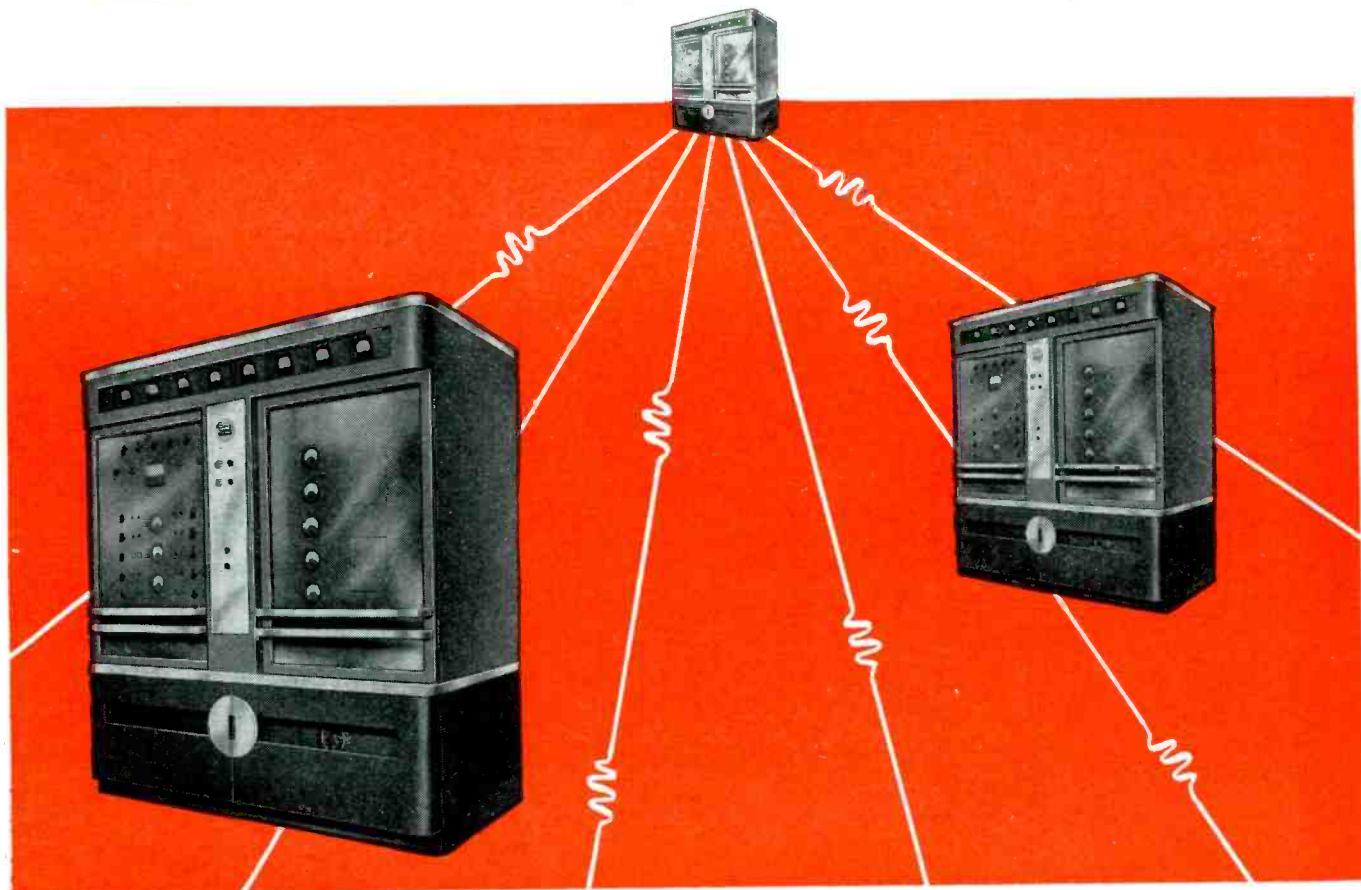

For many years, HARVEY OF CAMBRIDGE has built transmitters considered standards of quality and dependability. Yet, these new HAR-CAM FM Broadcast Transmitters that are about ready for release, will be far and away the finest ever to bear the HAR-CAM name.

Here's why:

As specialists in the manufacture and development of communications equipment, receivers as well as transmitters, for Commercial, Marine and Emergency use, we have gained a thorough knowledge and understanding of *all* phases of the industry. This sound background has been greatly enhanced by the additional skill and "know-how" gained through war work, par-

ticularly in the development and production of vital-Loran Radar Transmitters and other important communications units. Add to this improved production facilities and advanced precision methods of manufacture and you can readily understand why HAR-CAM FM Broadcast Transmitters will provide the last word in efficient, dependable and economical transmission.

Now is the time to get the complete story on these new HAR-CAM 250 and 1000 watt FM Broadcast TRANSMITTERS.

HARVEY RADIO LABORATORIES, INC.

439 CONCORD AVENUE · CAMBRIDGE 38, MASSACHUSETTS



NEW PRODUCTS

New materials, new components, new assemblies; new measuring equipment; new technical bulletins, and new catalogs

Electronic Depth Recorder

BENDIX-MARINE division of Bendix Aviation, Baltimore 4, Md., announces it will soon produce in volume a supersonic depth recorder for small boats and pleasure craft. The unit is designed to help make coastal navigation safer in fog and night and to locate fishing banks and schools of fish. Five vacuum tubes are utilized in the unit. Essentially there are two main units in the depth sounder; the recorder and the underwater transducer.

The cabinet of the recorder unit

mounts compactly in a ruggedly built, splashproof aluminum case which measures 10 x 16 x 21 $\frac{3}{4}$ in. It houses the graphic recording mechanism, signal sender, echo amplifier, synchronous driving motor and power pack. Total weight is 90 lb. The underwater unit is a special crystal transducer which weighs 22 lb. and measures 7 in. in diameter. The same transmitter which projects supersonic signals downward from the ship's bottom, also acts as the echo receiver.

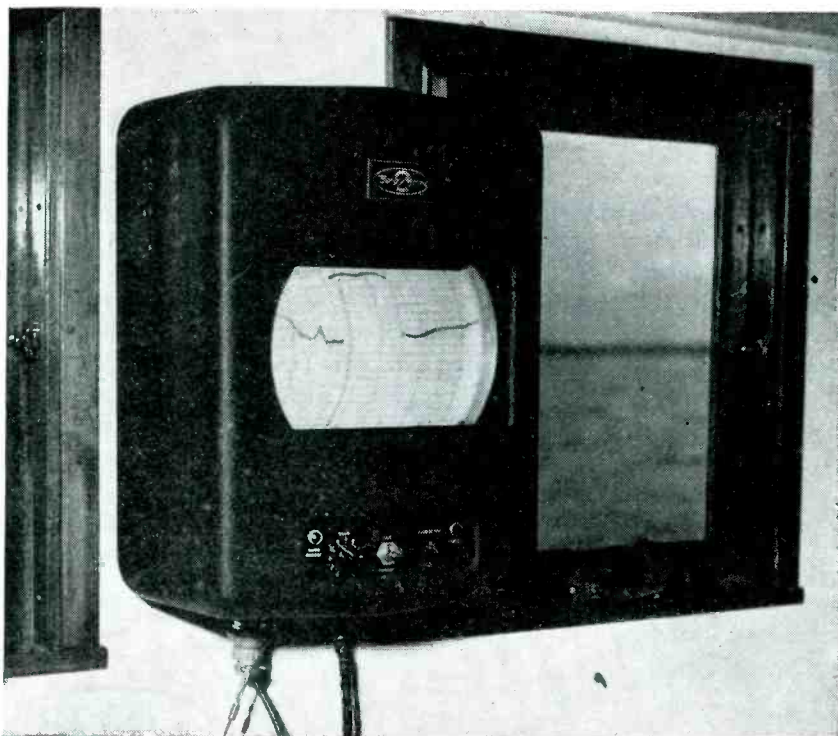

The recorder is shown mounted in the wheel house of a sea-going laboratory ship. Recordings made on Flushing Bay, N. Y. during a recent demonstration are shown here on the chart in the illustration. Lines at left and right show the depth of water in feet; the line at topcenter, the depth in fathoms. By changing the speed of the graphic recorder readings can be obtained either in feet or in fathoms

The device bounces a high-frequency signal off the bottom of the sea and draws a permanent and accurate picture of the ocean bottom. The design of the recorder minimizes maintenance costs. No special skill is required to maintain the unit.

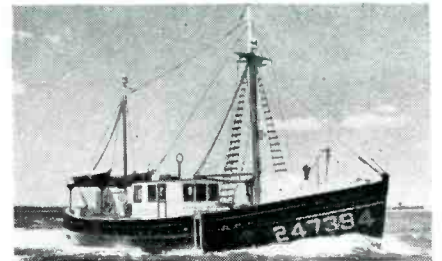

This view of the sea-going laboratory ship shows the outboard rigging (on the starboard side) which makes possible the use of the depth sounder developed as a completely portable unit

Plate Circuit Relay

STANDARD TYPE PLATE circuit relays (LMR Series) are available in both single and double pole contact arrangements. Single pole relays measure 2 $\frac{1}{4}$ x 2 $\frac{3}{8}$ x 1 $\frac{1}{8}$ in. Double pole types measure 2 $\frac{1}{4}$ x 2 $\frac{3}{8}$ x 2 $\frac{1}{8}$ in. Mounting dimensions are 2 tapped holes 6-32 thread, 1 $\frac{1}{8}$ -in. center to center. Relays are constructed with extra large coils to make them sensitive and to give good contact pressure at low current values. Standard adjustment is approximately

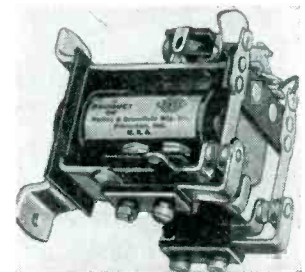

0.1 w for sp types, and 0.2 w for the dp types, with lower values available if necessary. Unless specified, contacts are of $\frac{1}{16}$ -in. fine silver. Coils are available in all resistances up to 10,000 ohms. Contact arrangements available include spdt; spst normally open; spst, normally closed; dpdt dpst, normally open; and dpst, normally closed. Potter & Brumfield Mfg. Co., Inc., 214 Linden Ave., Princeton, Ind.

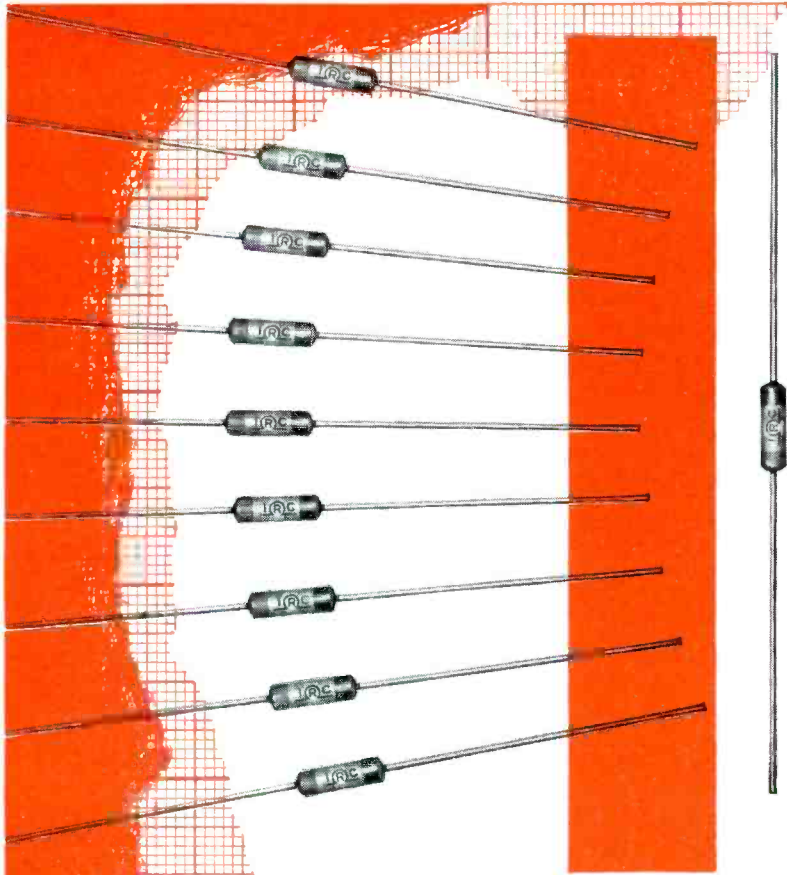

IRC TYPE **BWS**
 $\frac{1}{4}$ WATT INSULATED
 WIRE WOUND RESISTORS

Here's a brand new IRC resistor that until a few weeks ago was very "hush-hush" except to a few selected laboratories and prime contractors engaged in development and manufacture of VT proximity fuzes. Production on this small, efficient unit, in the last several months before V-J day, mounted to amazing figures to keep pace with the advancing victory tempo. Now this same high quality resistor is available in quantity to help solve many a "small space" resistance problem for you. Rated a full quarter watt, small 'round as a match stick and but $\frac{13}{32}$ " in length, this sturdy insulated wire wound can be depended upon for "Preferred Performance." For technical data refer to IRC Engineering Bulletin No.3, available on request from Dept. 1-L.

INTERNATIONAL RESISTANCE CO.

401 NORTH BROAD STREET • PHILADELPHIA 8, PA.

In Canada: International Resistance Co., Ltd., Toronto

IRC makes more types of resistance units, in more shapes, for more applications, than any other manufacturer in the world.



Electronic Tachometers

NEWEST ADDITIONS to Hewlett-Packard Company's (Palo Alto, Calif.) group of laboratory and production testing instruments are hp models 505A and 505B electronic tachometers. The tachometer (consisting of a photocell and light source hook-up) used in conjunction with an electronic frequency meter, is used to measure the speeds of moving parts over a range from about 300 rpm (5 rps) to 3,000,000 rpm (50 rps). The unit is capable of measuring very high speeds of rotating parts which have small energy, or which cannot be mechanically connected to any measuring device. Danger of making multiple or fractional errors are eliminated, and an

instantaneous record of the continuous speed is provided. A recorder connected to the output of the instrument makes a permanent record of these readings. Speeds below 300 rpm can be measured with the unit by means of slight additional preparation of the shaft or surface to be measured. Model 505A is calibrated in rpm; model 505B in rps. Some suggested applications include measurements of small, high speed motors, ultracentrifuges, or the electronic frequency meter can be used alone to measure the frequency of alternating current at frequencies as high as 50 kc. A technical data sheet is available from the manufacturer.

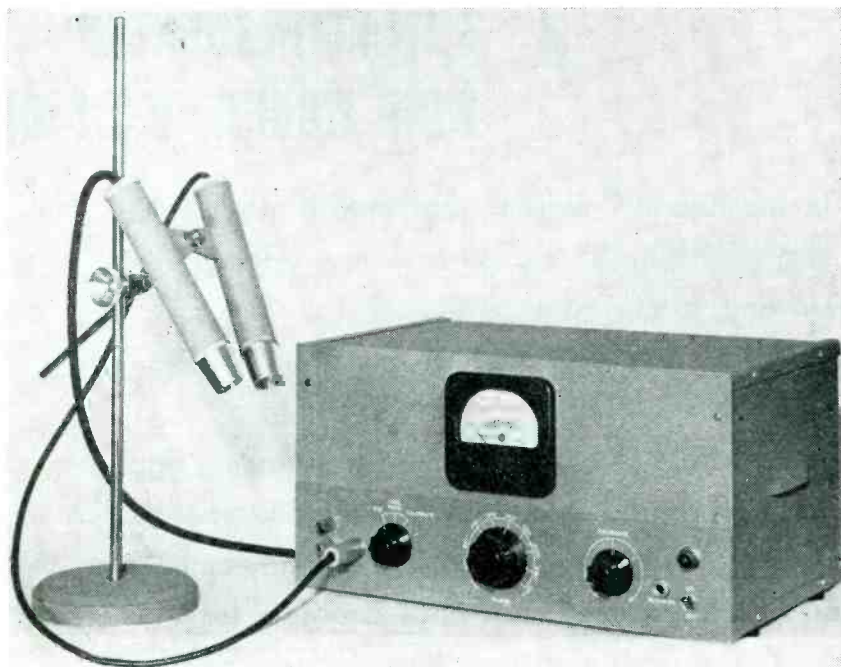

Collins Radio Products

COLLINS RADIO Co., Cedar Rapids, Iowa, announces:

A new 4-channel high fidelity remote amplifier (type 12-Z) which embodies circuit refinements and component improvements. The unit weighs less than 35 lb, is easily and quickly placed in operation, and has self-contained power supplies, both a-c and d-c, the latter in the form of batteries. Front-access attenuators, provide easy maintenance. A mas-

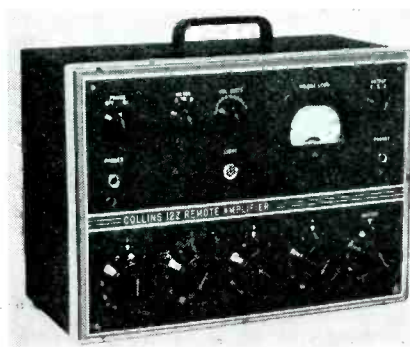

ter control is provided in addition to the individual control for each channel. A meter calibrated in v-u indicates the volume level, and also is used to measure operating voltages. Monitoring facilities are also included. Input impedance is 30/50 ohms. Output is 50 mw at less than 1 percent distortion into a 600-ohm load. The frequency response is 30-12,000 cps, ± 1.0 db. Overall gain is approximately 95 db.

Type 12-Y remote amplifier is a lightweight, single channel, high



fidelity amplifier suitable for dance orchestra and newsroom pickup, sports broadcasts, and any other application where fast set-up is important. It weighs 7 lb in its carrying case, has three stages of amplification for a maximum gain of 84 db, a universal input, and 600-ohms output. The unit operates from 110 v, ac, 60 cps. Power supply is self-contained.

Type 21-A a-m broadcast transmitter for the 540-1600-kc range

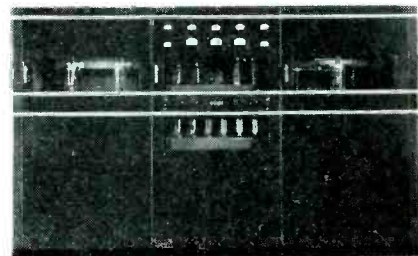

has an audio frequency response curve flat from 30-10,000 cps, ± 1.5 db. Noise level is more than 60 db below 100 percent modulation. Distortion is less than 3 percent rms. The carrier frequency is maintained constant to within ± 10 cps. The transmitter carries full FCC approval for 5000 and 1000 w high-fidelity broadcast operation. Power output of 1 kw can be obtained instantaneously by operating a switch which controls plate voltages.

Type 300-G a-m broadcast transmitter utilizes high level class B modulation. It is rated 250/100 w.

... Comparative Graph Proves SHURE Super-Cardioid Microphone twice as unidirectional as Cardioid ...

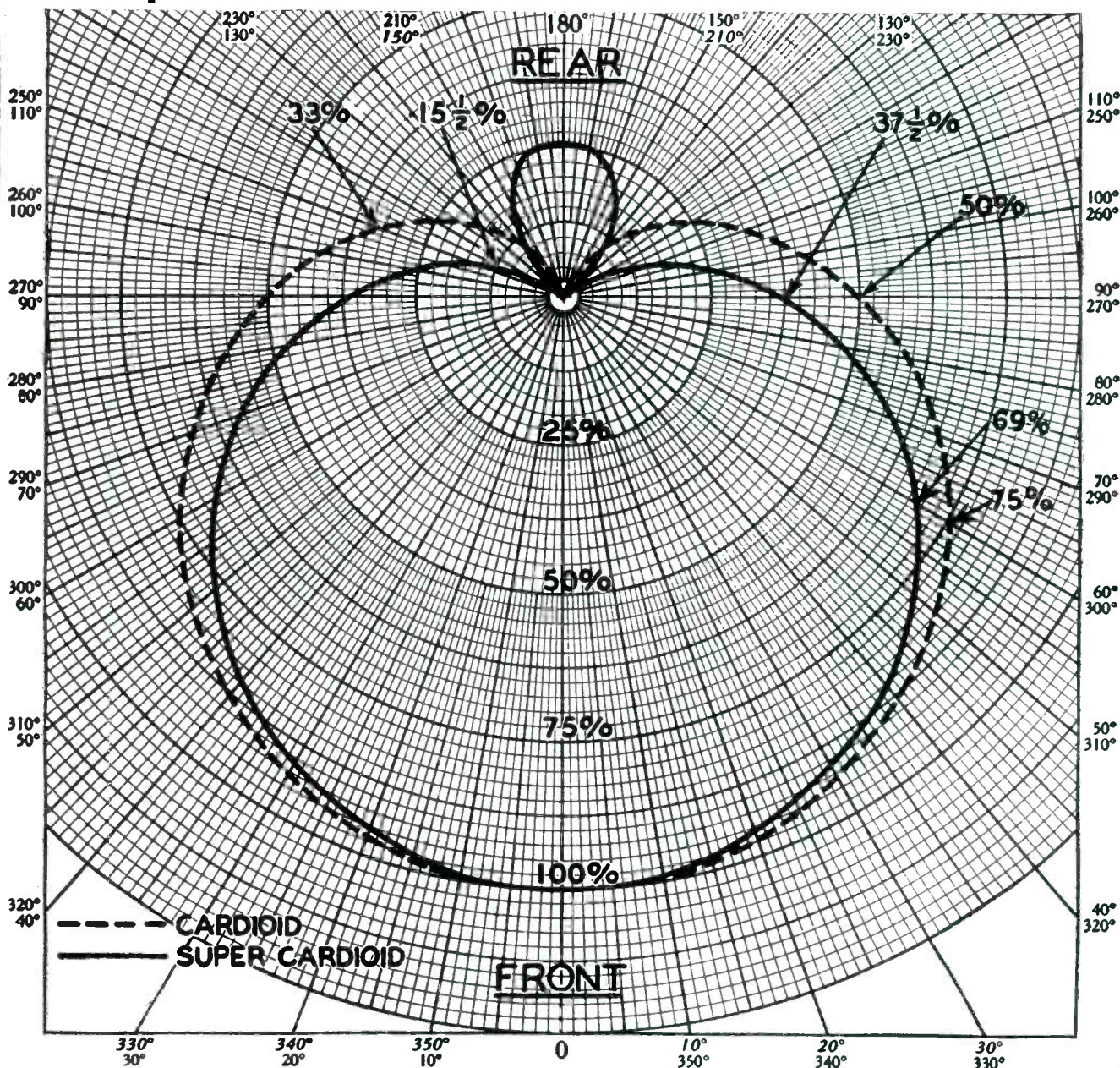

Here is the difference in pickup patterns between the Cardioid and the Shure Super-Cardioid Microphone. Maximum sensitivity (100%) is achieved by sound approaching the Microphone, directly at the front. At 60° off the front axis sensitivity of the Super-Cardioid is only slightly less than the sensitivity of the Cardioid (69% against 75%). The Super-Cardioid insures, therefore, a wide range pickup at the front. Beyond the 60° angle, the sensitivity of the Super-Cardioid decreases rapidly. At 90°, the sensitivity of the Cardioid is 50%; the sensitivity of the Super-Cardioid 37½%; 12½% less. For sounds approaching at a wide angle at the back (110° to 250°) the sensitivity of the Cardioid is 33%; the Super-Cardioid 15½% or 17½% less. It has been proved mathematically that the ratio of front to rear pickup of random sound energy is; *Cardioid* 7:1; *Super-Cardioid* 14:1.

This additional directional quality is important in critical acoustic work. The Shure Super-Cardioid, employing the exclusive "uniphase" principle, gives such performance in a single, compact rugged unit.

SHURE BROTHERS

Designers and Manufacturers of Microphones and Acoustic Devices
225 W. Huron St., Chicago 10, Illinois • Cable Address: SHUREMICRO



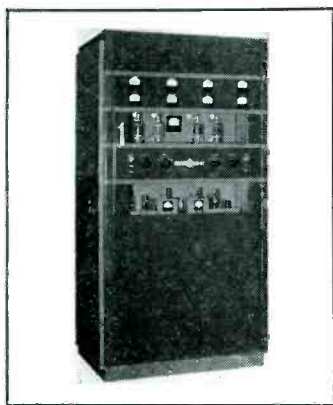

The frequency response is flat from 30 to 10,000 cps, with a maximum derivation of ± 1.0 db. Two separate temperature-controlled oscillator units are standard equipment, either of which will maintain the carrier frequency to within ± 10 cps. Power output can be reduced from 250 watts to 100 watts by a switch on the control panel. All circuits are properly metered.

Radioactivity Meter

TYPE R-M-82 R METER is a sensitive electronic device for measuring, directly, very weak radiations from small quantities of radioactive materials. It will indicate values from 0.000001 to 20.0 R units. The meter is calibrated directly in fractions of R units on a linear scale of a 4-in. meter. It has five R ranges which are quickly selected by pushbuttons. Full scales on these ranges at maximum voltage are: 0.0001, 0.001, 0.01, 0.1 and 1.0 units. By using minimum voltage the least sensitive range can be extended to 20 R units for full scale. The meter proper is an electronic device which measures currents as low as 0.001 ma. A high-voltage power supply with adjustable output from 100 to

2000-v d-c is part of the apparatus. Safety switches are provided so that there is no possibility of the operator being exposed to the high voltages. High sensitivity of the unit does not affect its stability. Especially trained personnel is not required to operate the instrument. Various types of units are employed for holding the chemicals to be measured. The illustration shows one of several arrangements. In this case the material holder and electrodes are enclosed in a bell jar for evacuation. The unit operates from 115-v, a-c, 60 cps. It is housed in two steel cases, each measuring approximately 11 x 8 x 8 in.

Rowe Radio Research Laboratory Co., 2422 N. Pulaski Rd., Chicago 39, Ill.

Vacuum Switches, Capacitors

THREE GENERAL ELECTRIC (Electronics Dept., Schenectady, N. Y.) vacuum switches are available for such applications as limit switches, thermostatic controls, radio antenna switching, inertia-controlled devices, stratospheric applications or radio transmitter tank-coil assembly switching. Features of these switches include extreme flexibility (either slow operation or thousands of contacts per minute); low resistance contact; immunity to oil, water, and dust; non-inductive switch-control circuit; elimination of separate low-voltage control circuits; low contact pressure; small operating force; and long contact life. They are noiseless and vibrationless, mount in any position, require little space and no maintenance, reduce fire and explosion hazards, and easy to install and handle.

Type GL-1S21 is designed for high-frequency and high-altitude applications. It's circuit is a spdt

type; maximum hold-off voltage across stationary contacts is rated approximately 7500 rms; maximum continuous current rms, 20 amp. The interrupting rating, resistive load for total life of 1000 operations at 7500 volts a-c rms is rated 15 amp a-c rms; 1,000,000 operations at 7500 volts a-c rms is 3 amp a-c rms total life of 500,000,000 operations at 7500 volts a-c rms is rated 0.1 amp a-c rms. The other type switches include types FA-6 and FA-15 which utilize spdt type circuits. Type FA-15 has a maximum voltage, a-c, of 3000 rms and a maximum continuous current, rms of 15

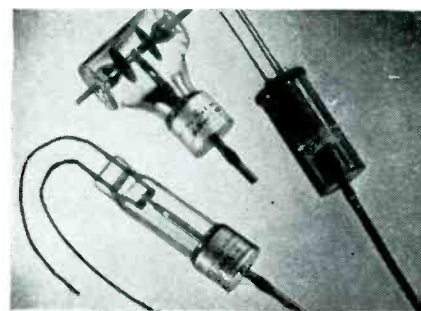

amp. Type FA-6 has a maximum voltage, a-c of 550 rms and a maximum continuous current, rms of 10 amp. Bulletin No. EXT-1 describes these units.

G-E vacuum capacitors have been designed for circuits where the peak voltages range from 7500 to 16,000 volts. They are for use as plate-tank and by-pass capacitors in diathermy equipment, and in other r-f oscillators or amplifiers. They can also be used as neutralizing capacitors in r-f amplifiers in conjunction with small, low-capacitance padding capacitors. Types GL-1L32, 1L21, 1L36, 1L38 and 1L33 are the 7500-v types with ratings of 6, 12, 25, 50 and 100 μmf capacitance respectively. Types GL-1L31, 1L25, 1L22, 1L23 and 1L24 are the 16,000-v types with ratings of 6, 12, 25, 50 and 100 μmf capacitance respectively. Bulletin No. ETX-2 describes them in more detail.

Federal Products

HIGH-VOLTAGE selenium rectifier stacks, hermetically sealed in glass, are available in several tube lengths and in various voltages up to 4000 volts from Federal Telephone &

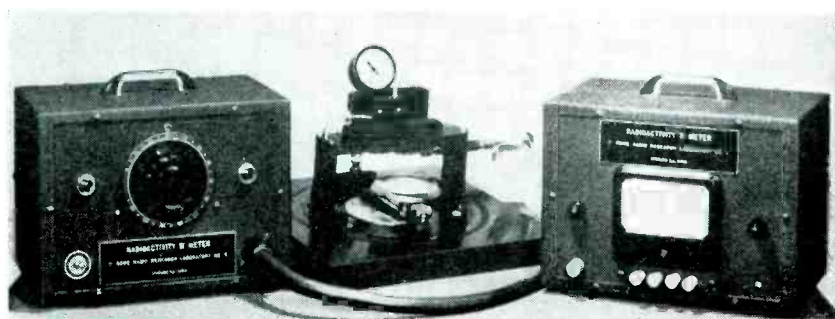

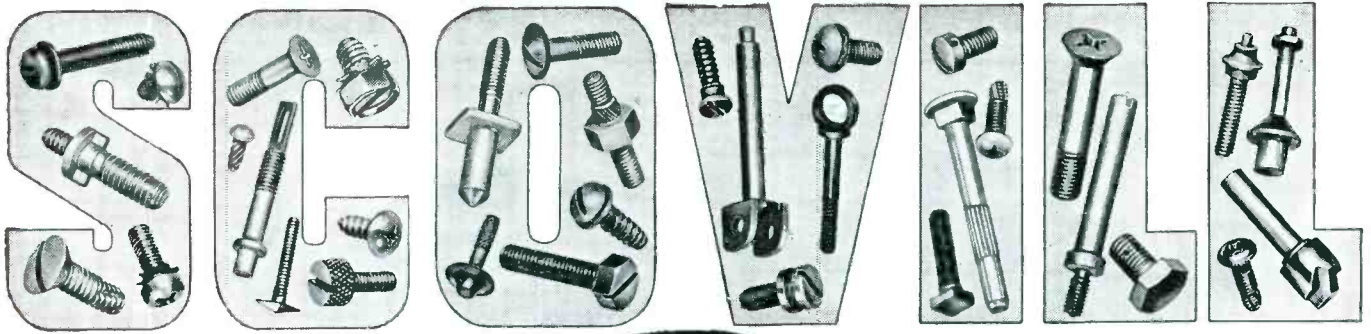

**FOR SPEED
AND PRECISION
IN THAT VITAL
ASSEMBLY JOB**

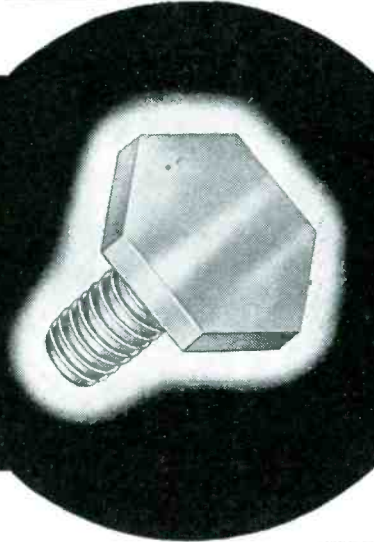

**PLAN
FASTENINGS
NOW**

"Cold-forging"—proof #35...more each month

Play Safe—Plan Today:

This period of increased competition demands fast, precise assembly, calls more and more for fastenings of special design. Planning fastenings in the product-design stage may well solve your vital assembly problem. Early action enables you to make the exact choice—a featured standard fastening or a part especially designed to meet your specific requirements. No assembled product is better than its fastenings—and no fastenings are better than Scovill fastenings.

Play Safe—Choose Scovill:

Years of specialized experience in fastenings qualify us to help you make that exact selection—our demonstrated ability in special design* makes Scovill your logical choice.

This, plus our special processing, our ingenuity in cold-forging, means a substantial saving in *money—materials—motions*.

Call A Scovill Fastenings Expert Today

*Illustrated above is one of many special-purpose items—proof of Scovill ingenuity in cold-forging and ability in special design.

**3 Standard Fastenings
for Production Efficiency**

- 1 Phillips Recessed Head Screws**—The modern, effective, time-saving fastening device proven in tens of thousands of assembly lines. Other standard head styles are also available.
- 2 Self-Tapping Machine Screws**—Eliminate separate tapping operations for fastenings to castings, heavy gauge sheet metal, and plastics. Also available with Phillips Recessed Head.
- 3 Washer-Screw Assemblies**—When use of lock washers is indicated, the time-saving of pre-assemblies is obvious. Also available in standard slotted head styles.

SCOVILL MANUFACTURING COMPANY

WATERVILLE SCREW PRODUCTS DIVISION

WATERVILLE 48, CONN.



TEL. WATERBURY 3-3151

NEW YORK, Chrysler Building • DETROIT, 6460 Kercheval Avenue • CHICAGO, 135 South LaSalle Street • PHILADELPHIA, 18 W. Chelton Avenue Building
PITTSBURGH, 2882 W. Liberty Ave. • SYRACUSE, Syracuse-Kemper Insurance Bldg. • LOS ANGELES, 2627 S. Soto St. • SAN FRANCISCO, 434 Brannan St.

LOW

FREQUENCIES

Actual Size

ACCURACY TO 1/1,000th of 1%

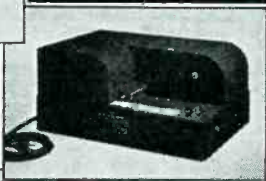
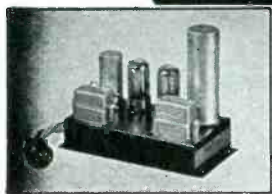

TOP
FREQUENCY STANDARD
(60 cycle) for use with
external power supply

CENTER
CHRONOGRAPH
Records time intervals
with resolution to .001 second

BOTTOM
FREQUENCY STANDARD
(120 cycles) with
self-contained power supply

These tuning forks which include new engineering principles, provide frequencies from 120 to 1,000 cycles directly with an unqualified guarantee of accuracy to 1 part in 100,000 over a wide temperature range. (Better than 1 second in 24 hours). Closer tolerances are obtainable on special order.

These tuning fork assemblies are available only in single or multi-frequency instruments of our own manufacture which are de-

signed to test, measure or control other precision equipment by mechanical, electrical, acoustical or optical means.

The dependability of these frequency standards is being demonstrated for myriad purposes in all climates and under all working conditions.

If you have need for low frequency standards of exceptional accuracy, your inquiries are invited.

American Time Products, Inc.

580 Fifth Ave.

New York, N. Y.

Dist. of Western Electric &



Watch-rate Recorders

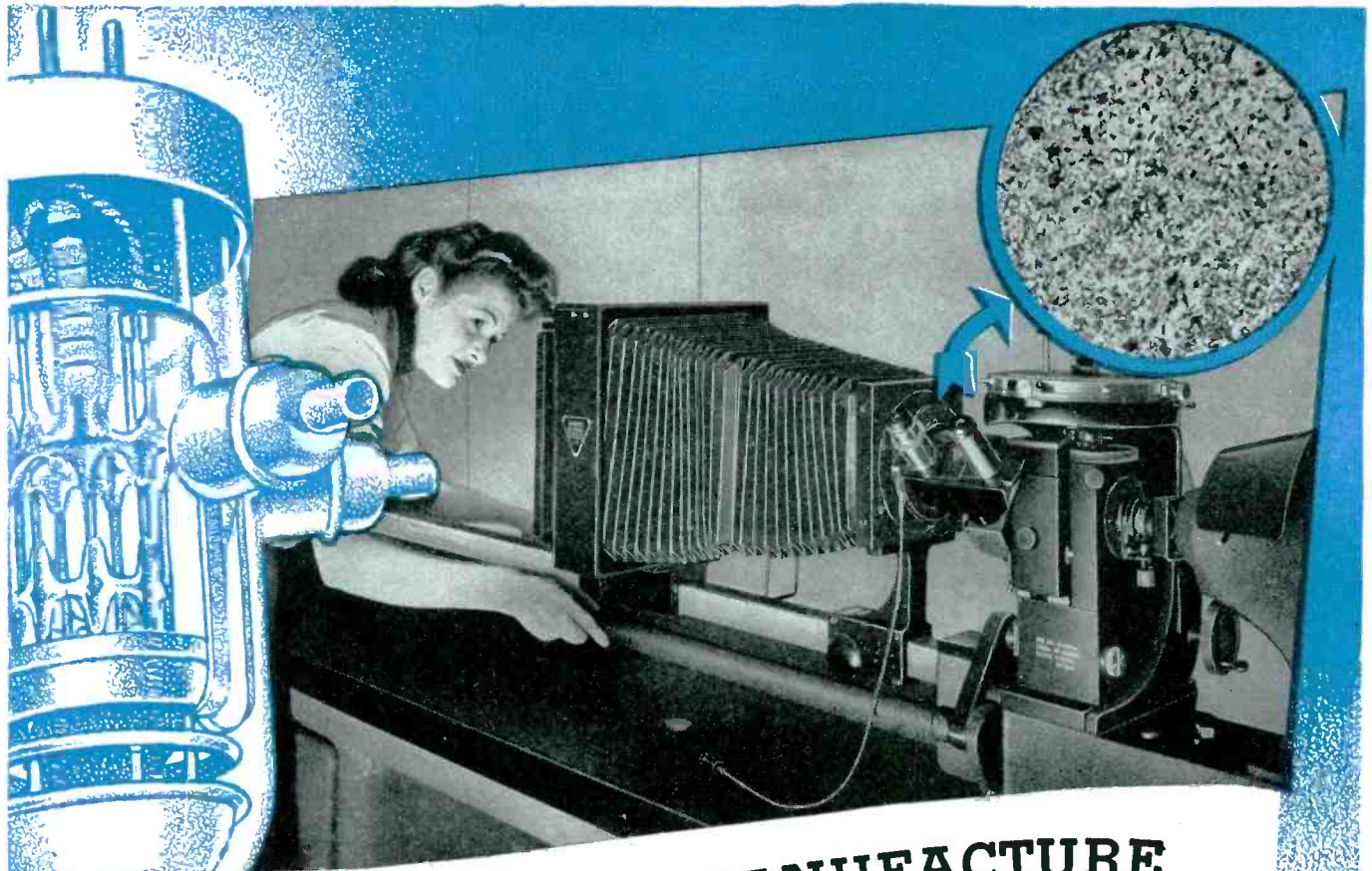

IN TUBE MANUFACTURE
 ALL SMALL DETAILS ARE **LARGE**
 TO *Federal*

From slender filament to anode block . . . *all* tube construction details, however small, are important to Federal. That is why this experienced and longtime manufacturer uses the illustrated high-magnification metallograph as part of its test equipment for checking raw material quality.

An example is the micro-photo inset. Here is shown oxide-free, high conductivity copper used for copper-to-glass seals . . . after the material has been reduced to a fine grain, non-porous structure through Federal's special metal-processing methods.

But whether copper, molybdenum or tungsten . . . they all are subjected to the same exclusive treatment and put through the same searching scrutiny . . . assurance that only the finest materials go to make up Federal tubes.

This exacting test is another good reason why Federal tubes are better tubes. Transmitting, rectifier, industrial-power . . . they have a reputation that is deserved because they are *built to stay*.

Federal always *has* made better tubes.



Federal Telephone and Radio Corporation



Newark 1, N. J.

More Adaptable
**TO YOUR
 PARTICULAR NEEDS**

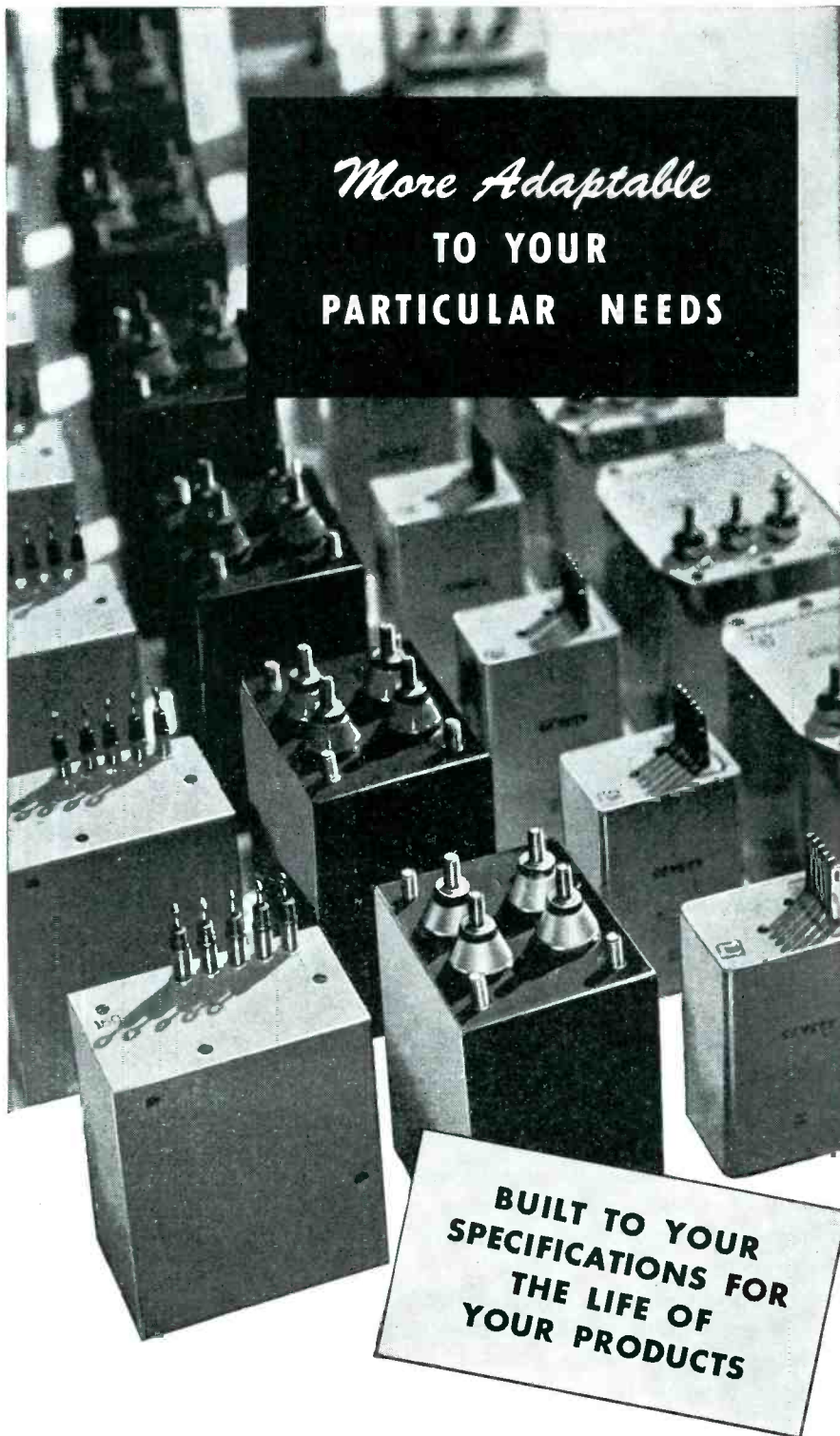

**BUILT TO YOUR
 SPECIFICATIONS FOR
 THE LIFE OF
 YOUR PRODUCTS**

THE know-how gained in engineering transformers to war's exacting specifications is now available to solve your peacetime transformer needs. Stancor engineers are ready to study and master the toughest problems you can set them. Production men trained to exacting standards, with modern equipment and precision winding machinery, assure that highest specifications will be met in the finished product.

When you have a transformer problem, think first of Stancor. Competent sales engineers are ready to satisfy your most exacting transformer requirements.



STANCOR
 STANDARD TRANSFORMER CORPORATION
 1500 NORTH HALSTED STREET CHICAGO 22, ILLINOIS

Radio Corp., 67 Broad St., New York 4, N. Y. Stacks are easily and quickly installed. Electrical connection is made through heavy silver-plated ferrules at each end of the glass tube. The size of these ferrules permits mounting in 30-amp fuse clips unpolarized or polarized by addition of a simple member to the fuse clip assembly. Units are

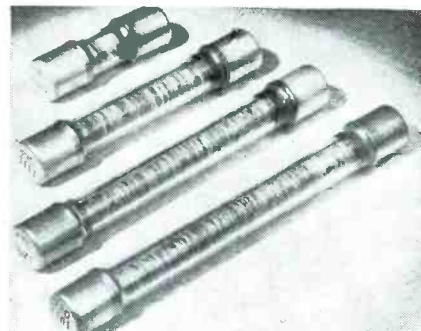

light-weight, have long-life, and provide silent, trouble-free operation. The rectifiers can be used for application with cathode-ray tubes in television, or as high-voltage, low-current rectifiers for a wide range of uses in other electronic devices.

Other Federal products include a comprehensive line of iron core magnetic components, custom-built to meet specific requirements and incorporating design innovations. Available with power ratings ranging from milliwatts to kilowatts, components can be provided in any

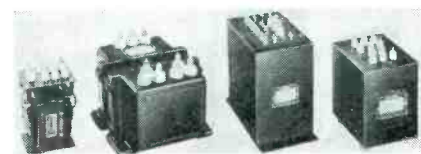

of the basic types of construction—open, frame, semi-enclosed, and hermetically sealed. Various terminal types can be supplied, including standard nut-fasteners and solder-type binding posts with porcelain bases. Hermetically sealed units utilize either compression bushings on porcelain bases, or glass-to-metal fusion seals in one piece covers. This type of seal withstands successive immersion in ice-water after hot tin dip. Applications of the components include plate and filament supplies, audio-frequency and modulation transformers, power transformers and reactors.



that assures Balance in High Frequency Lines

PRECISION MANUFACTURE is extremely important in all types of coaxial cables, especially where the success of complex networks depends on perfect balance.

The construction of Anaconda Coaxial Cables provides conductors not only symmetrically accurate, but ruggedly resistant to distortion and mechanical failure. Metal braiding is always substantially woven to prevent fraying and to stand up under continuous flexing.

In view of the rapid advancement in this field we offer engineering service for designing special types of low loss insulation cable.

48291



ANACONDA COAXIAL CABLES

Anaconda coaxial cables are made in many types to Army-Navy specifications.



ANACONDA WIRE & CABLE COMPANY

GENERAL OFFICES: 25 Broadway, New York City 4

CHICAGO OFFICE: 20 North Wacker Drive 6 • Sales Offices in Principal Cities

Subsidiary of Anaconda Copper Mining Company

"AEROTROLS"

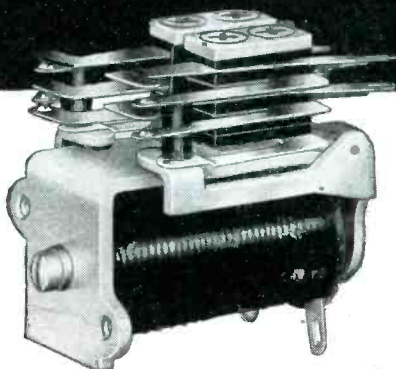

The Small Relays with the Big Performance

- Engineered and manufactured for the necessities of military aircraft operation, Cook "Aerotrols" have opened new fields in electrical and electronic remote control applications in radio-radar, wire communications, mining, manufacturing, testing and innumerable other fields where greater dependability and accuracy must be provided.

- Here are some of the general specifications of the "Aerotrol" "400" Series relays. The size of the "Aerotrol" without springs (the frame, coil and armature) is $1\frac{5}{16}$ " wide, $1\frac{7}{16}$ " long and 1" high. Spring assemblies add to overall height, up to 1" for 6 springs. Average weight for two spring pile-ups is $1\frac{3}{4}$ oz. The coil spool is one piece, moulded bakelite. Heel piece is arranged for two mounting screws with solder terminal for coil located at the armature end, at which end also, spring solder terminals are located. Coil winding capacity can be provided up to 10,000 ohms and for positive operation on current values as low as 2 milliamperes. Coil treatment normally includes impregnation

with fungus lacquer and Insulex covering, and where required, the coil is treated for high humidity and other tropical conditions.

- "Aerotrols" are small, compact, yet rigidly constructed relays that have proven their dependability, not only in laboratory tests, but in actual operation under the most severe wartime conditions all over the world.

- "Aerotrols" are "application engineered" to provide specific performance suitable to circuit and control conditions. There are many selective features that can be incorporated into these relays. Bushings and insulators can be provided made of Cook patented "Cecotite" ceramics, to provide freedom from carbonization and wear, and to provide permanent stability of original adjustment and rapid frequency of operation. Mounting arrangements can be provided to meet installation conditions, including the plug-in types.

- "Aerotrols" of various types, such as time-delay, latching, A.C. or D.C., both single and double pile-ups, can be supplied.

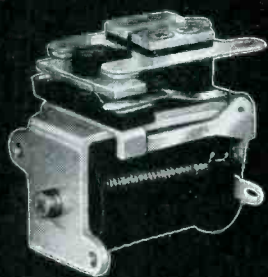

Illustrated above is an "Aerotrol" heavy current relay, with two Form "A" contacts operating on a double armature.

SEND FOR BOOKLET AR-145 FOR INFORMATION ON THE COMPLETE LINE OF "AEROTROL" RELAYS.

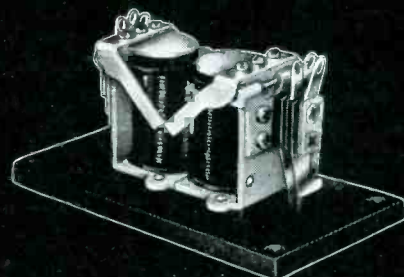

Illustrated above is a latching type "Aerotrol" combining two type "401" "Aerotrols." Any combination of the "400" series relays can be combined into a latching "Aerotrol."

COOK ELECTRIC



Company

CHICAGO 14, ILLINOIS

The Public expects...

and visualizes Postwar Radio Receivers vastly superior to anything known during Prewar years. Forward looking manufacturers of radio receivers will serve the public with what it wants . . . the latest in radio receivers . . . with every known improvement in design and component.

Most significant of newly developed components is the Franklin AIRLOOP. Its values, by comparison with prewar and conventional loops, are amazing.

- Optimum Sensitivity
- High Uniform "Q" Over Entire Band
- Inductance to Close Tolerance Without Adjustable Turn
- Low Distributed Capacity
- 27% Greater Effective Loop Area
- Electrical and Mechanical Stability
- Backboard and Loop In One
- Lower Cost
- Elimination of Individual Loop Adjustment on Assembly Line
- Maximum Space Utilization (cabinet depth)
- No Haywire

Franklin AIRLOOPS

...SYMBOLIC OF POSTWAR RADIO RECEIVERS!

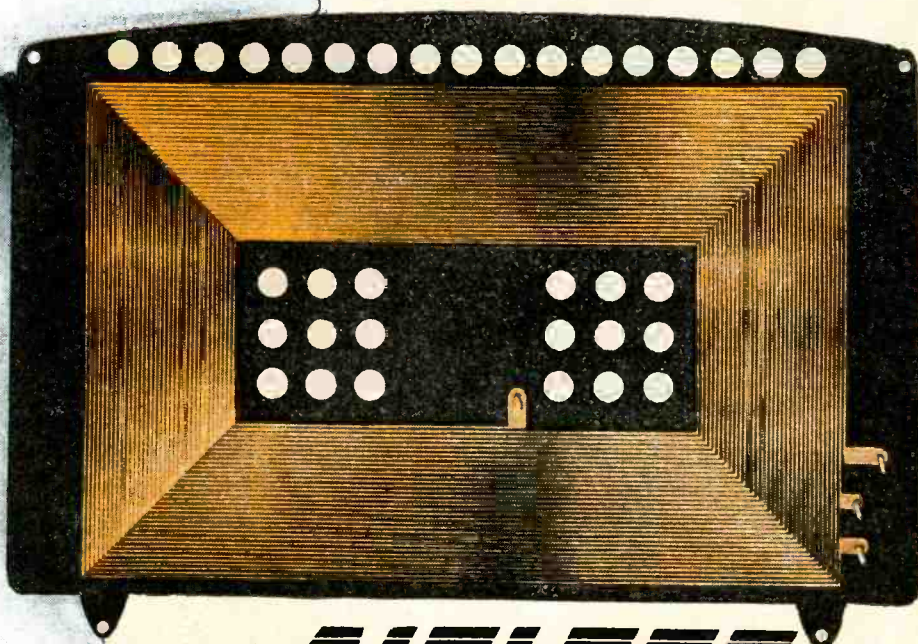

THE AIRLOOP

AIR DIELECTRIC THROUGHOUT ITS ENTIRE LENGTH

A radio engineers' dream come true . . . Flat sheets of copper die-stamped into perfect super-sensitive loops . . . The greatest development in loop antenna design and manufacture since 1920 . . . Being rectangular the Airloop has 27% more effective area . . . Better performance at lower cost . . . No set builder can afford to overlook the significance of the Airloop.

INVESTIGATE....and you will...SPECIFY AIRLOOPS

Franklin **AIRLOOP**
175 VARICK ST., NEW YORK 14, N. Y. corp.

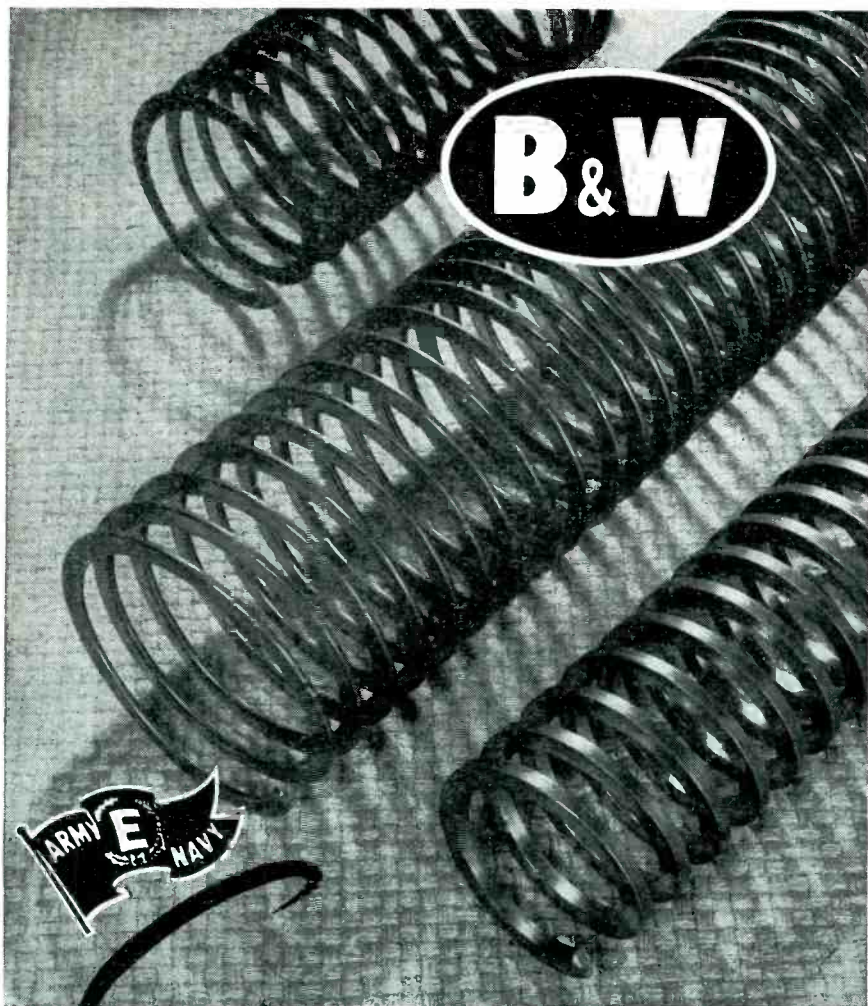

Edgewise WOUND INDUCTORS FOR R-F HEATING

A rugged, heavy duty inductor is a vital necessity for the construction of generators for R-F Heating. Experience has shown that B&W Edgewise Wound Inductors are admirably suited for this purpose. Requiring less space for a given amount of inductance, they also offer more heat dissipating surface than wire, for a given cross-sectional area.

B&W Edgewise Inductors can be furnished in coils from 1¼" inside to diameters in excess of 10 inches. The minimum size of strip is ¾" x .050" while the maximum is 1" x .250". Inside or outside mountings are available either in plain or tapped coils. Rotary or continuously adjustable units are available with either inside or outside contact. Prompt delivery can be made on all types.

When designing your new electronic heating equipment, be sure and consider B&W Edgewise Inductors.

BARKER & WILLIAMSON

235 FAIRFIELD AVE., UPPER DARBY, PA.

Export: LINDETEVES, INC., 10 Rockefeller Plaza, New York, N. Y., U. S. A.

BRING COIL PROBLEMS TO COIL HEADQUARTERS!

Ultrahigh-Speed Relay

THE NEW STEVENS-ARNOLD Company (22 Elkins St., South Boston, Mass.) Millisec relay is a hermetically sealed sensitive relay capable of speeds up to 1,000 operations per second. The basic design of the moving elements makes the ultrahigh speed possible and assures reliability if operated in the usual



speed ranges. A glass envelope surrounds all moving parts and protects them from moisture, dust or corrosive fumes. Sensitivities down to ½ mw are possible. Ratings up to 5 amp can be obtained. Closing time can be less than 1 millisecond. Outside dimensions of relays rated at 115-v, a-c, 1-amp, are 3 in. high and 1½ in. base diameter.

Frequency Meters

VIBRATING REED frequency meters manufactured by Aero Instrument Co., 3907 San Fernando Road, Glendale 4, Calif., are direct reading frequency indicators for use on lines where the successful operation of a-c equipment depends upon maintenance of known or constant frequency. They are self-contained, requiring no auxiliary apparatus. They consist of a number of steel reeds, of high Q, each of which is tuned to a single frequency within the band covered by the instrument. Indication is by the visual pattern formed by the vibration of the reed in resonance with the line frequency. Excitation is electro-magnetic, and the reeds are the only moving elements. Frequency ranges are available from 10 cps to 500 cps in increments of half or full cycles. Meters of one cycle increment ranges can be read accurately to 0.5 cycle and meters of one-half cycle increment ranges can be read

Molding Plastics with Metal Inserts?

Electronic Preheating Can Help You



Users of this completely automatic RCA electronic preheater report production increases in usable molded parts of 50% to 500%! Cost reductions may pay for the equipment in a matter of months.

Wide experience of plastics molders shows electronic heat reduces rejects, simplifies molding, increases output 50%

If you are combining metal and plastics—if you are molding plastics parts with metal inserts—you'll find that electronic preheating can be of considerable help. Speedy electronic preheating provides almost amazing plasticity...allows you to mold at low pressure.

Because molding pressures are low, the danger of forcing inserts out of line is greatly reduced. Furthermore, the possibilities for mold damage are practically eliminated. Along with these important advantages, electronic preheating makes for a generally improved product and considerably increased production rate.

If you are a molder, RCA engineers will gladly advise you on the proper equipment and procedures to use in obtaining improved results with electronic preheating. You will find greatly increased production, and lowered over-all costs. Records kept by molders using electronic preheating show production increases of usable parts as high as 500%,

and cost reductions of at least 50% — all costs included. Send the coupon below for details.

If you are a plastics buyer and do not do your own molding, ask the custom molder who serves you about electronic preheating. He may be able to solve a problem for you by the use of electronic preheating. A recent survey conducted for RCA among plastics molders shows that an overwhelming majority of those questioned prefer electronic preheating as the Number One method of preheating because it gives a better molded product at higher production rates.

RCA Electronic Heating Equipment specially designed for the plastics industry offers a combination of advantages obtainable from no other manufacturer. The pace-setting RCA 2000-watt unit (Model 2B) has set the design standard for the industry. Completely automatic, it can turn out a pound of uniformly heated preformed material at 275°F in only 40 seconds—25% to 50% faster than non-automatic units. Operating cost (including tubes, power, maintenance, and depreciation) is as low as 20 cents per hour! Send coupon for free bulletin. Write details of your plastics-molding problem to RCA application engineers. Address: *Radio Corporation of America, Electronic Apparatus Section, Box 70-204H Camden, N. J.*

RCA
ELECTRONIC
HEAT



**RADIO CORPORATION
OF AMERICA**

RCA VICTOR DIVISION · CAMDEN, N. J.

MAIL COUPON TODAY

FREE BOOKLETS ON PLASTICS PREHEATING:

RCA, Electronic Apparatus Section,
Box 70-204H, Camden, N. J.

Please send me free information on improved plastics molding with economical RCA electronic heat.

- "Electronic Heat Speeds Plastics Molding"
- "RCA Electronic Generator—Model 2B—For Plastics"
- "RCA Electronic Generator—Model 15B"

Name

Position

Company

Address

City Zone State

70-6250-204

REMEMBER-

AT THE POINT OF SALE-

"Eye Appeal Means Buy Appeal!"

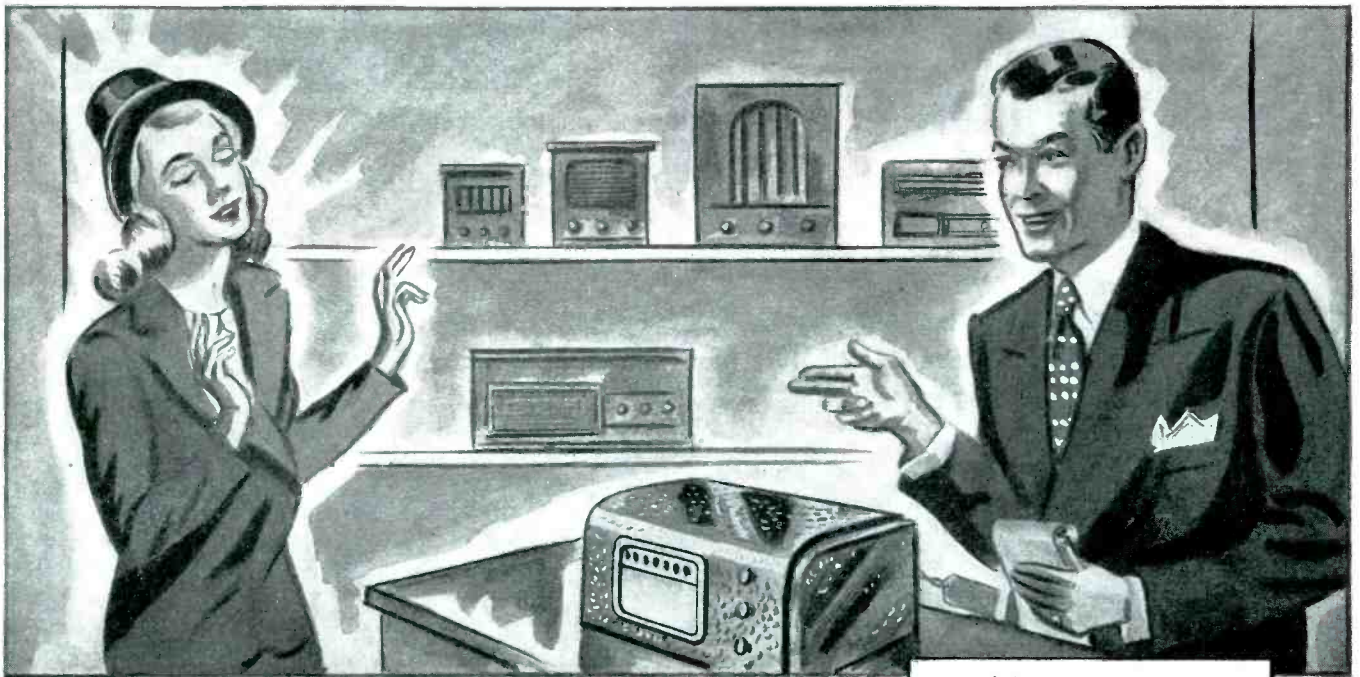

She's buying a new radio—one of the many post-war items that all America is hungry for. Your name on the set will be sufficient guarantee of good workmanship and dependability, but she's going to ask for more than that! She's going to demand a thing of beauty—an object that will be an attractive addition to her home.

M & W's Hammertone finish will provide that beauty and give your product a high degree of eye appeal at the point of sale. Hammertone is a tough, durable finish which simulates hammered metal. It is available in silver, copper and many other colors for use on metal, plastic or wood products.

For information on Hammertone or any of the other many M & W industrial finishes, contact the branch office nearest you or write direct to



WE ARE HEADQUARTERS FOR SOLVING INDUSTRIAL FINISH PROBLEMS!

Have you a special finishing problem? Let us develop the right finish to meet your requirements.

MAAS & WALDSTEIN COMPANY, NEWARK 4, N. J.

PRODUCERS OF LACQUERS, ENAMELS, SYNTHETICS AND SPECIALTY FINISHES FOR ALL PURPOSES

BRANCHES: 1658 CARROLL AVE., CHICAGO 12 • 6 JERSEY ST., BOSTON 15 • 1228 W. PICO BLVD., LOS ANGELES 15



In this method **OF TOOL AND DIE MAKING**
YOU BUY LESS STEEL AND REDUCE
MACHINING COSTS

**WRITE
FOR THIS
BOOKLET**



It gives you details of FCC Air Hardening, Oil Hardening and other Cast-To-Shape Tool Steels and describes other FCC money-saving Tool Steel Specialties.

Get your copy—write for it today.

ADDRESS DEPT. E-36

FCC Cast-To-Shape, the modern method of tool and die making, is effecting important savings of time, trouble and money for an increasing number of manufacturers.

Even very intricate shapes can now be cast successfully within an eighth inch of finished size. This means that you buy less steel at the start and reduce machining costs substantially.

Tools which could not be made by conventional methods except in sections can often be fabricated from FCC Cast-To-Shape blanks in a single piece.

In many instances performance of the tool is better than can be

obtained by fabrication from bar stock or forgings.

Particulars are available through Allegheny Ludlum representatives; or write for the booklet today.



**ALLEGHENY
LUDLUM**

STEEL CORPORATION
Forging and Casting Division
 DETROIT 20, MICHIGAN

For Blue Ribbon Blueprints



USE ARKWRIGHT TRACING CLOTHS!

If awards were being given for blueprints of outstanding excellence, those made with Arkwright Tracing Cloth would certainly be in the Blue Ribbon class! Arkwright cloths contain no surface oils to become opaque and brittle with age. Exceptionally high, longer lasting transparency is obtained by Arkwright's exclusive mechanical processing methods.

EASES AND SPEEDS WORK. You'll find no pinholes, specks, dirt, stains or other imperfections to detract from its use as a drawing material or lower the quality of your reproductions.

TOUGH AND SERVICEABLE. Arkwright Tracing Cloths take erasure after erasure without smudging or wearing through. And re-inking is done without "feathering" or blotting. Countless copies can be made without tearing, fraying or curling of the original drawing.

FREE SAMPLES. Samples of this work-easing, job-improving cloth will be sent free on request to test on your own drawing board. Write: Arkwright Finishing Company, Providence, R. I.

Sold by leading drawing material dealers everywhere



Arkwright
TRACING CLOTHS
 AMERICA'S STANDARD FOR OVER 20 YEARS

to 0.1 cycle by comparing the relative amplitudes of the reeds. The following standard models are available out of stock and for early production in large quantities: Model 7004, range 59 to 63 cps; model 7007, range 57 to 63 cps; model 7005, range 48 to 52 cps; model 7006, range 58 to 62 cps; model 7009, range 47 to 54 cps; model 7002, range 48 to 52 and 58 to 62 cps; model 4009, range 380 to 420 cps.

Another instrument produced by Aero is Model No. 1001 running-time meter which is also direct reading for use on a-c lines. It is for use in applications where the successful operation of equipment depends upon the regular servicing of such equipment based on actual lapsed time. This meter automatically and cumulatively registers the total operating (or idle) time of any equivalent, machine, circuit or system to which it is connected. It has a range from 0 to 9999.9 hours, and resets automatically at 10,000 hours.

Small Latching Relay

THESE NEW, SMALL latching relays are called "Latching Aerotrols" and are made by combining two of the manufacturer's standard line of Aerotrol 400 Series relays, with an interlocking armature. This design makes it possible to combine any two Aerotrols of similar or different types into a latching relay. They can be supplied in either single or double pile-ups and with all standard spring pile-up formations and combinations. Mounting arrangements are designed to specification. Units are available for either a-c or d-c operation with maximum voltage of 125-v d-c, or 120-v 60 cycle a-c. Dimensions are 1 1/8 x 2 3/8 x 1 1/8 in. Magnetronic Div. of Cook Electric Co., 2700 Southport Ave., Chicago 14, Ill.

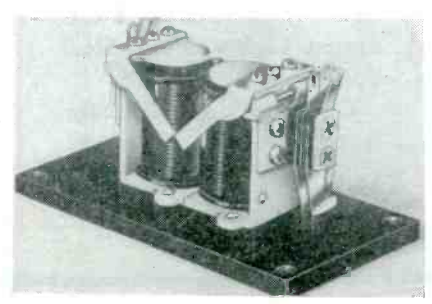

WHY SPEED NUTS ARE FIRST

*with Time Study and
Cost Departments*

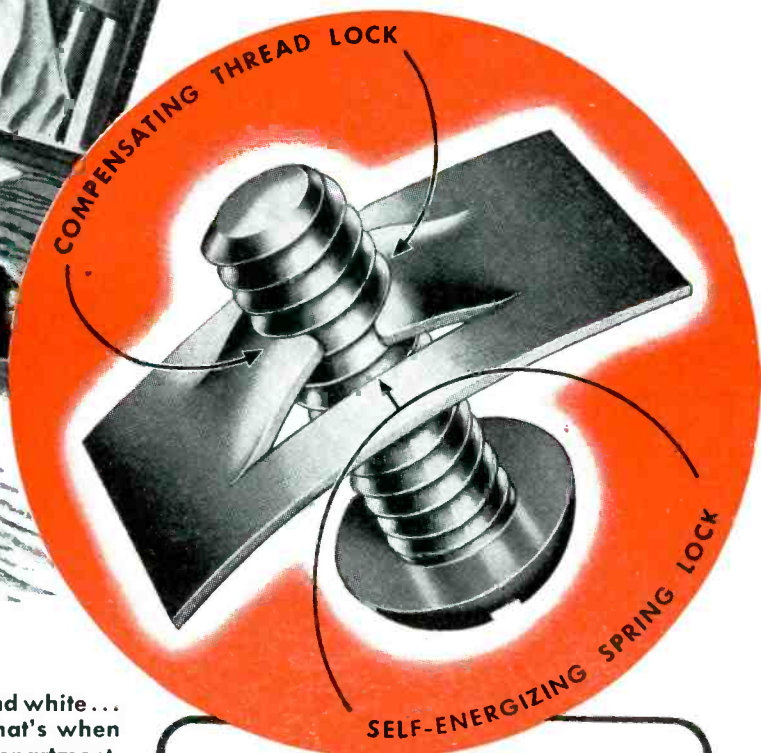
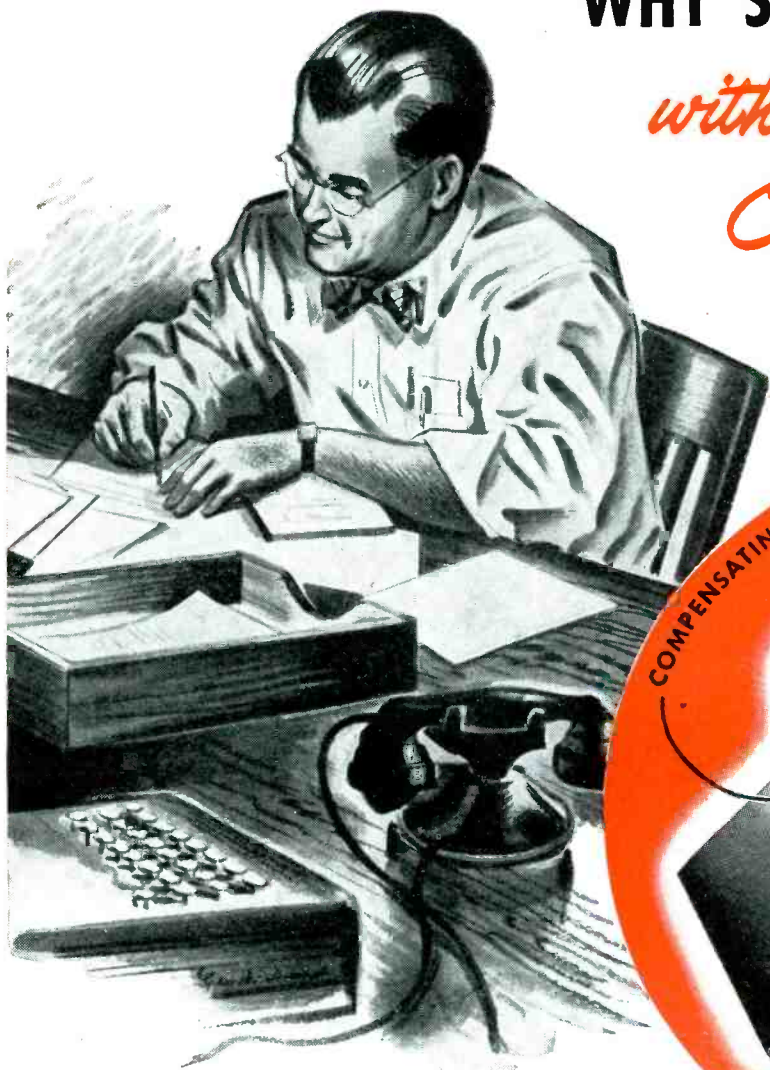

When ALL assembly costs are down in black and white... when TOTAL net assembly costs are figured... that's when SPEED NUTS really show results in the Cost Department.

For SPEED NUTS reduce assembly costs in many ways. They completely eliminate lock washers—saving the cost of the washers and the time necessary to handle and install them. Moreover, hundreds of SPEED NUTS have been designed to perform multiple functions and eliminate two or more assembly parts.

SPEED NUTS are applied faster and easier to speed up assembly. They can't "clog" with paint or enamel to delay the assembly line. "Self-retaining" types of SPEED NUTS do away with expensive welding and clinching operations. And SPEED NUT spring-tension resiliency also protects porcelain, plastic or glass parts against damage in transit.

A letter describing your fastening problem will bring you full details on how SPEED NUTS will reduce YOUR total net assembly costs, too.

NOTHING LOCKS LIKE A SPEED NUT

Only SPEED NUTS provide a COMPENSATING thread lock and a SELF-ENERGIZING spring lock. As the screw is tightened the two arched prongs move inward to lock against the root of the screw thread. These free-acting prongs COMPENSATE for tolerance variations. Compression of the arch in prongs and base creates a SELF-ENERGIZING spring lock. These two forces combine to definitely prevent vibration loosening.

TINNERMAN PRODUCTS, INC. • 2106 Fulton Road, Cleveland 13, Ohio

*In Canada: Wallace Barnes Co., Ltd., Hamilton, Ontario
In France: Aerocessoires Simmonds, S. A., Paris*

*In England: Simmonds Aerocessories, Ltd., London
In Australia: Simmonds Aerocessories, Pty. Ltd., Melbourne*

Speed Nuts 

PATENTED

* Trade Mark Reg. U. S. Pat. Off.

FASTEST THING IN FASTENINGS... OVER 3000 SHAPES AND SIZES

ANOTHER WILCO DEVELOPMENT

SILVER JACKETED WIRE

WILCO Silver Jacketed Copper Wire now widely used for coils in **Short Wave Radio Communications Systems**.

PROPERTIES AND CHARACTERISTICS—WILCO Silver Jacketed Copper Wire—an economical non-corrosive wire with solid-silver characteristics—is used successfully in many *electronic* applications, where high frequency currents are a problem. Another WILCO jacketed type combines great physical strength with high conductivity. A third unites stamina with highly desirable electrical characteristics. In fact there is almost no limit to WILCO facilities for combining metals of widely differing physical and electrical properties to meet individual engineering needs.

Gold, silver, copper, brass, bronze, iron, steel, nickel, monel and invar, are all utilized in producing WILCO'S uniform, non-porous, securely bonded jacketed wire and rolled strip.

CONSULT OUR ENGINEERING DEPARTMENT—Write our Engineering Department for help in developing the proper application of WILCO materials to your products.

SEND FOR WILCO BLUE BOOK—The Blue Book contains charts, formulae and full descriptions of all Jacketed Materials and other WILCO products. Send for FREE copy today.

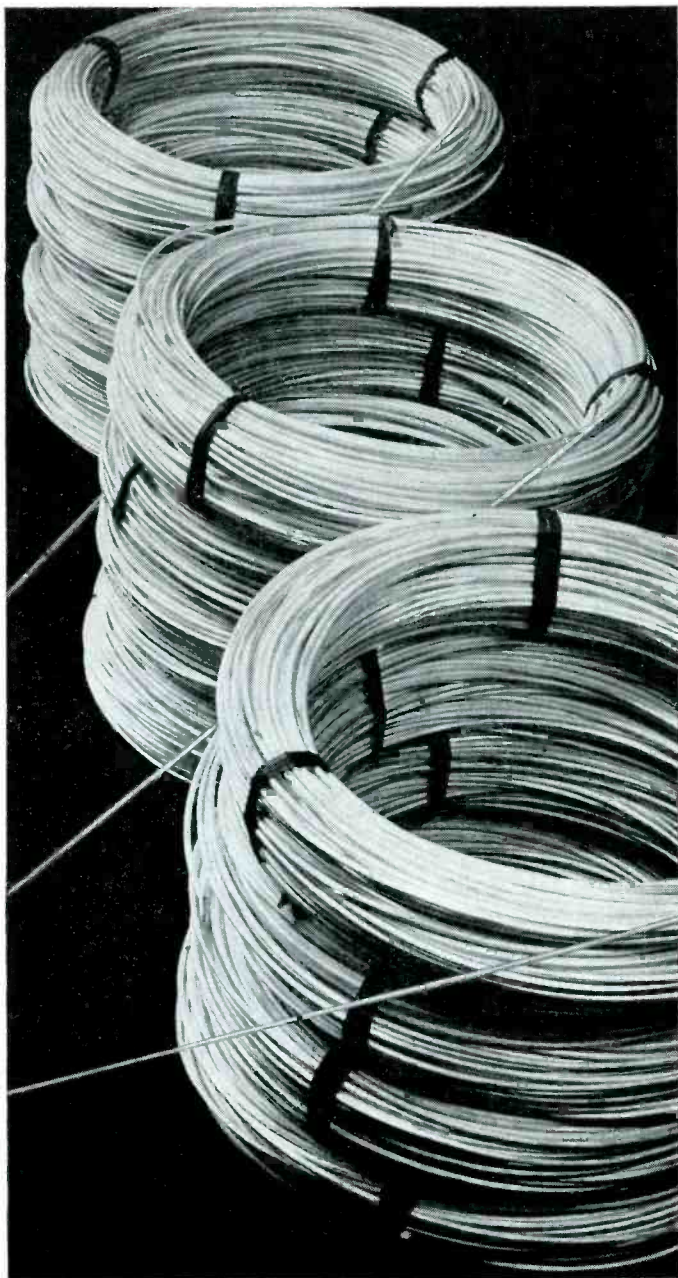

WILCO PRODUCTS INCLUDE:

Contacts—

Silver
Platinum
Tungsten
Alloys
Sintered Powder Metal

Thermostatic Bimetal—

High and Low Temperature with new high temperature deflection rates

Precious Metal Collector Rings—

For rotating controls

Silver Clad Steel Jacketed Wire—

Silver on Steel, Copper, Invar or other combinations requested

Rolled Gold Plate

Special Materials



THE H. A. WILSON COMPANY

105 Chestnut Street, Newark 5, N. J.

Branch Offices: Chicago • Detroit • Los Angeles

**SPECIALISTS FOR 30 YEARS IN THE MANUFACTURE OF • THERMOMETALS
ELECTRICAL CONTACTS • PRECIOUS METAL BIMETALLIC PRODUCTS**

GET THIS 2 WAY PROTECTION

FOR MOTORS • GENERATORS • TRANSFORMERS



Time Delay
Thermal Overload Protection
Instantaneous Trip
Overcurrent Protection

DT-1—THERMO-MAGNETIC RELAY

HERE IS HOW IT WORKS —

Above 10 times normal current the magnetic trip operates. From 10 times down to 1.25 the circuit opens after the indicated time delay.

● If you want to avoid expensive breakdowns of equipment due to unsafe overloads, you need the dual protection of the Roller-Smith type DT-1 Thermo-Magnetic Relay.

You get protection from dangerous overloads by means of a bimetal relay that opens the circuit

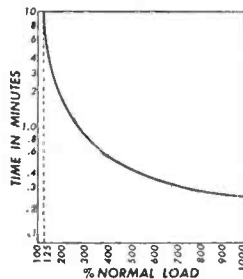

before the winding temperature of the protected equipment becomes dangerous. There is a time delay before the relay opens which runs around 10 minutes at 125% rated load and 15 seconds at 1000% rated load. The magnetic trip operates instantly for currents in excess of 10 times rated load, the control circuit opens and the equipment comes off the line. For detailed information on the application and operation of the DT-1 overload relay, write for Catalog 6240 to Department E-6.

ROLLER SMITH



Switchboard Instruments

BETHLEHEM • PENNSYLVANIA

In Canada: Roller-Smith Marsland, Ltd., Kitchener, Ontario

STANDARD AND PRECISION ELECTRICAL INSTRUMENTS • AIRCRAFT INSTRUMENTS • SWITCHGEAR
 AIR AND OIL CIRCUIT BREAKERS • ROTARY SWITCHES • RELAYS • PRECISION BALANCES

SMALL But Stand-outs!

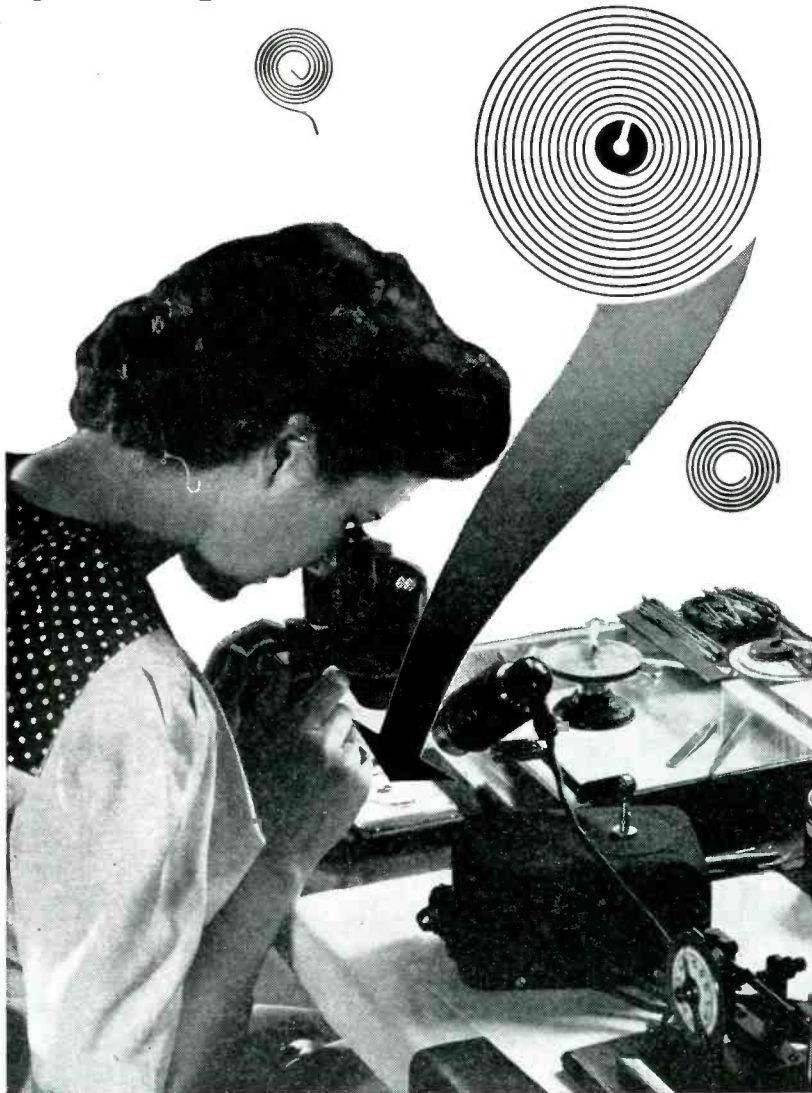

Manross tops the field in sensitive springs for instruments, gauges, relays, etc. Materials to suit your conditions of use—processed to give accurate, long-lived service. Sound design—carefully controlled production in any quantity.

MANROSS *hair springs*

F. N. MANROSS & SONS
DIVISION OF ASSOCIATED SPRING CORPORATION
BRISTOL, CONNECTICUT

Radar Tube

GRAPHITE ANODES replace tantalum in these air-cooled radar transmitting tubes (type VT-127-A) to increase their life approximately thirty times over earlier types. The tube is called Marathon because specifications of the armed forces called for a minimum life of 500



hours in radar service and life tests in the field showed that the tubes were going strong at 5000 hours. Continuing field tests showed no signs of failure at the end of 10,000 hours. Sylvania Electric Products, Inc., Emporium, Pa.

Wire-Wound Resistors

ACCURATE FIXED wire-wound resistors, designated as type 188 Akra-Ohm, are small, close-tolerance units rated at 1 w with maximum resistance of 1 meg and having axial leads for convenient mounting by the leads on standard terminal strips. Units measure $1\frac{1}{8} \times \frac{3}{8}$ in. The 3-in. axial leads of No. 20 tinned copper wire permit use of the resistor either in original equipment or as replacements in circuits where car-



bon resistors are not sufficiently accurate or stable. Standard tolerance is ± 1 percent, although higher accuracy up to ± 0.1 percent is available on special order. These units supplement the manufacturer's previous axial lead, type 181-A rated at 0.3 w and having a maximum resistance of 150,000 ohms. Shallcross Mfg. Co., Jackson & Pusey Ave., Collingdale, Pa.

BENDIX *V.H.F.* RADIO

EQUIPMENT FOR THE AIRLINE GROUND STATION



MR-71B RECEIVER

- DUAL CHANNEL
- FIXED FREQUENCY

Now—a *new* Bendix Radio Receiver engineered for the airline ground station and designed for V.H.F. (Very High Frequency) fixed frequency radio reception.

Built to the quality requirements that have made Bendix Radio products "Standards for the Aviation Industry," the MR-71B V.H.F. Radio Receiver functions on a frequency range of 118-132 Mc.—

—provides dual channel operation, extreme

sensitivity, high selectivity, excellent stability.

—incorporates positive squelch operation, rapid amplified AVC, and effective noise limiter.

—engineered so that all adjustments are available from front panel without removing unit from its rack.

For full information as to dimensions, weight, construction, electrical characteristics and service features, write the Sales Department, Bendix Radio Division, Baltimore 4, Maryland.



Bendix Radio DIVISION

BALTIMORE 4, MARYLAND



STANDARD FOR THE AVIATION INDUSTRY

Jennings
RADIO
VACUUM ELECTRONIC COMPONENTS

Vacuum Variable **CONDENSER!**

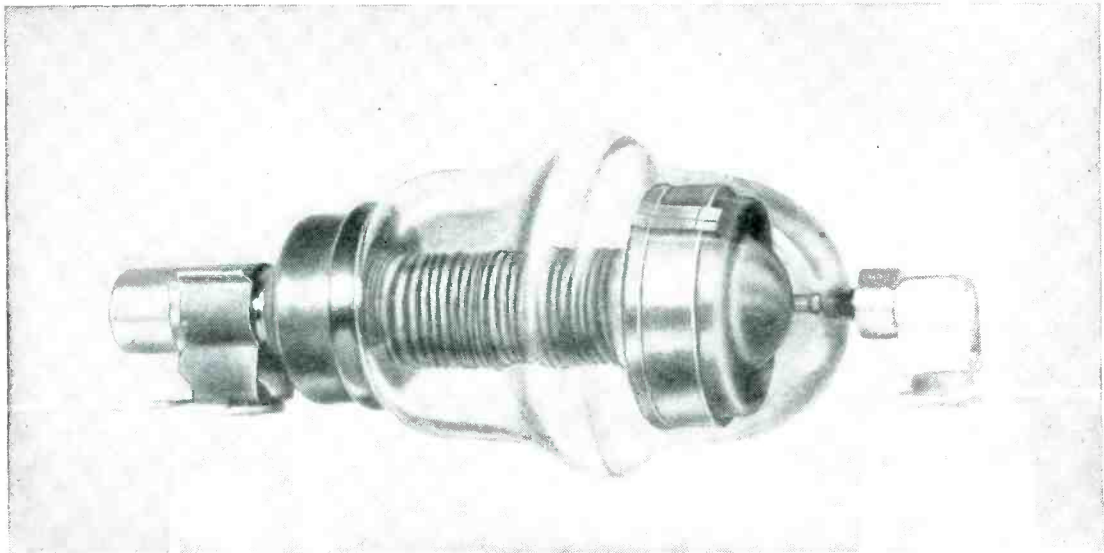

Patent Applied for

at Last—

After three years of development, Jennings has brought the **first** successful **Vacuum Variable Condenser** to the Electronic field.

For improved efficiency, reduced size and weight, these units should be used in tank, neutralizing or antenna tuning circuits in FM, AM and Television stations. Write for further details on this remarkable unit and other Jennings High Voltage Vacuum Capacitors in a wide range of sizes and capacities.

We welcome your inquiry and the opportunity to serve you.

WATCH JENNINGS FOR NEW DEVELOPMENTS IN THE FIELD OF SPECIALIZED VACUUM ELECTRONIC COMPONENTS.

WRITE FOR BULLETIN E

JENNINGS RADIO MANUFACTURING COMPANY • 1098 E. WILLIAM ST. • SAN JOSE 12, CALIFORNIA

PERMANENT MAGNETS MAY DO IT BETTER!



New Engineering Handbook on Permanent Magnets

If you are considering any application of permanent magnets to your product or manufacturing processes, you are welcome, without charge, to a copy of this new *Manual*.

This is a 32-page, illustrated reference work on magnets, prepared by the engineering and research staff of the world's largest producers. It contains data on the functions of

permanent magnets; an outline of basic types, with associated air-gaps; material characteristics; and information on their engineering, designing and manufacture. It has many useful formulae, charts, graphs and diagrams, of constant reference value.

Write today for your free copy of this *Manual*. Consultation with our engineers is invited.

*** THE INDIANA STEEL

6 NORTH MICHIGAN AVENUE, CHICAGO 2, ILLINOIS



PRODUCTS COMPANY ***

Corpr. 1945, The Indiana Steel Products Co.

SPECIALISTS IN PERMANENT MAGNETS SINCE 1910



New FOLDED UNIPOLE ANTENNA

Another Example of **ANDREW** Ingenuity in Engineering

Concentrating on electrical performance, Andrew engineers have designed a unique Folded Unipole Antenna which—according to comparative tests—easily outperforms other antennas at several times the price.

Used for transmitting and receiving at frequencies from 30 to 40 MC and for powers up to 5,000 watts, this antenna has proved so successful that similar models for higher frequencies are now being designed.

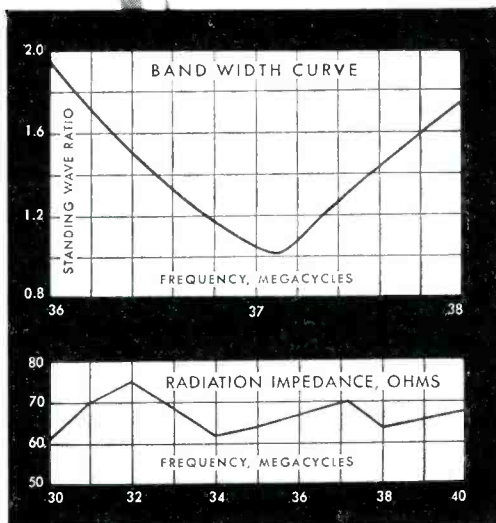

FEATURES:

- Light weight — only 15 pounds — simplifies installation.
- Lightning hazard minimized by grounded vertical element.
- "Slide trombone" calibration permits exact adjustment for any frequency between 30 and 40 MC, using only a wrench. Optimum performance for that frequency is guaranteed without "cut and try" methods.
- Proper termination of coaxial transmission line. Unlike other "70-ohm" antennas, the Folded Unipole actually provides a non-reactive impedance with a resistive component varying between 62 and 75 ohms (see lower curve).
- Excellent band width, ideal for FM (see upper curve).

Andrew Co. specializes in the solution of antenna problems. For designing, engineering and building of antenna equipment, consult Andrew Co.

ANDREW CO.

363 EAST 75th ST., CHICAGO 19, ILL.

WRITE FOR FULL INFORMATION

Coil Varnishing Machine

ILLUSTRATED is a semi-automatic coil varnishing machine used to impregnate r-f coils with a uniform coating of varnish, to close tolerances, in a minimum amount of time. The unit is driven by a $\frac{3}{8}$ hp synchronous motor. Weight of the varnish is controlled by adjustable

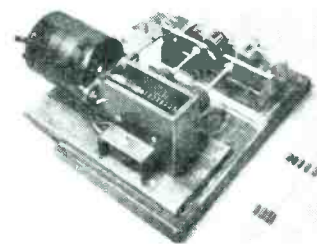

scrapers. An operator merely places a coil between two revolving drums and allows it several revolutions. A squeegee action created by the two revolving drums forces varnish between the coil turns. Coils are then ready for baking. Clippard Instrument Laboratory, Cincinnati, Ohio.

Spotting and Repeating Record Player

FAIRCHILD CAMERA & Instrument Corp., 88-06 Van Wyck Blvd., Jamaica 1, N. Y., announces its first postwar classroom teaching accessories, in the form of a simple, low-cost combination word-spotter record-player designated the Language Master, for schools, colleges, and other training centers. The unit is basically a record player with a device that permits accurately spotting and repeating any desired passages on a record for analysis. For



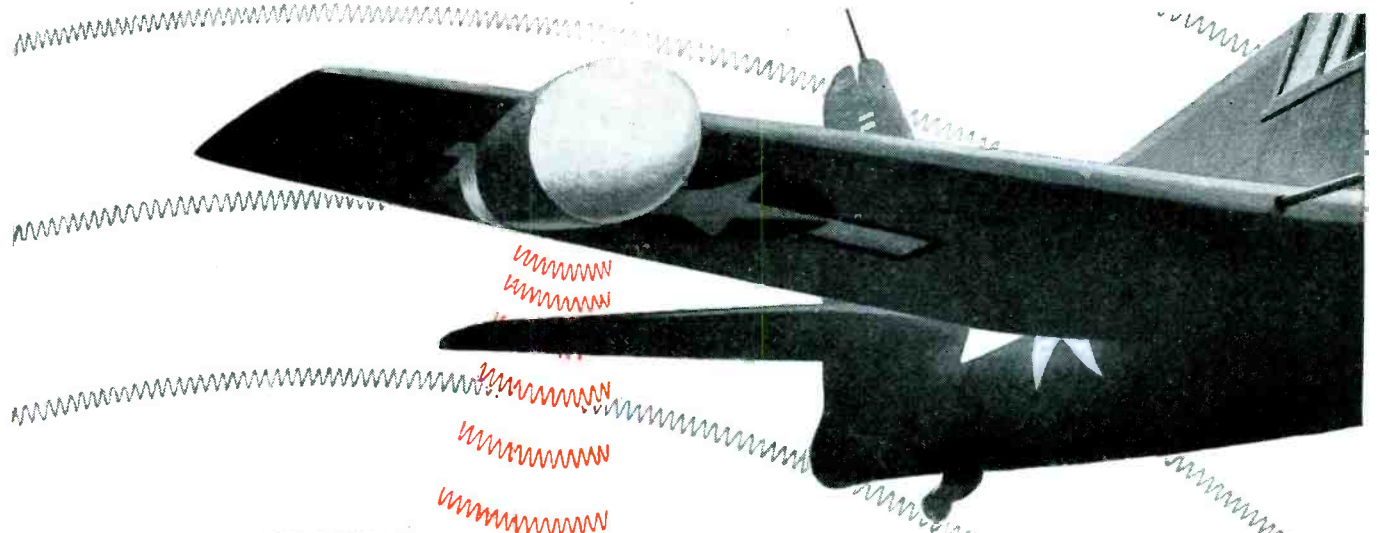

PRESENTING THE CASE FOR RADAR

AS THE STORY of radar unfolds, the nation becomes increasingly aware of the extreme importance of this one-time "secret weapon." And behind that story is another—about radically new types of housings that had to be developed before radar could perform its vital functions on land, at sea, and in the air . . . housings called radomes.* Certain types, such as the radome illustrated, were produced from woven glass cloth and BAKELITE laminating resins.

Manufacturers, designers, and engineers will be interested in the exceptionally exacting requirements that were met: low power factor and low dielectric constant at high radio frequencies; high tensile, flexural, and compressive strengths; and extreme weatherability. Still other advantages of this new and superior electrical insulating plastic included good color stability and resistance to marine growths. Productionwise, these laminated radomes were formed at low fabricating pressures, in comparatively inexpensive molds. They demonstrate the practicality and economy of forming large, intricate shapes by this laminating-molding technique at pressures frequently as low as one pound per square inch.

Write Department 68 for further information on BAKELITE resins for high-, low-, and contact-pressure laminating, and the names of the suppliers of the finished laminates.

*Radome illustrated through courtesy of Andover-Kent Aviation Corp.

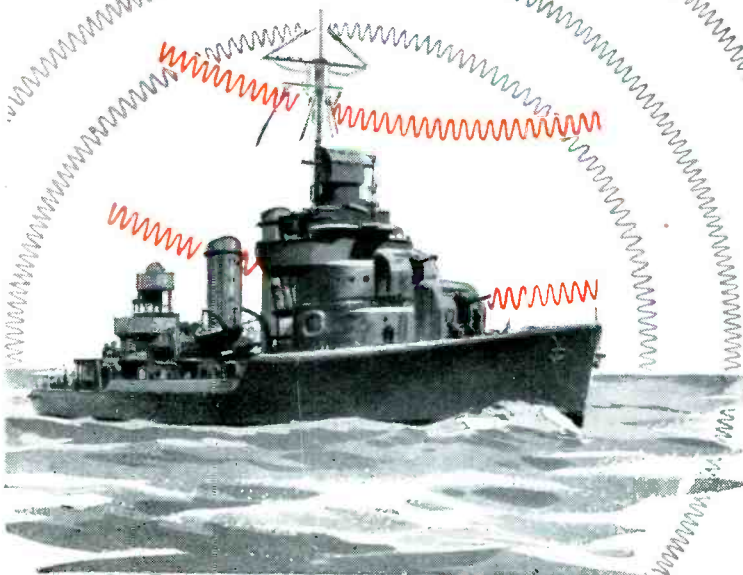

BAKELITE CORPORATION

Unit of

Union Carbide and Carbon Corporation



38 EAST 42ND STREET, NEW YORK 17, N.Y.

BAKELITE

TRADE-MARK

LAMINATING PLASTICS

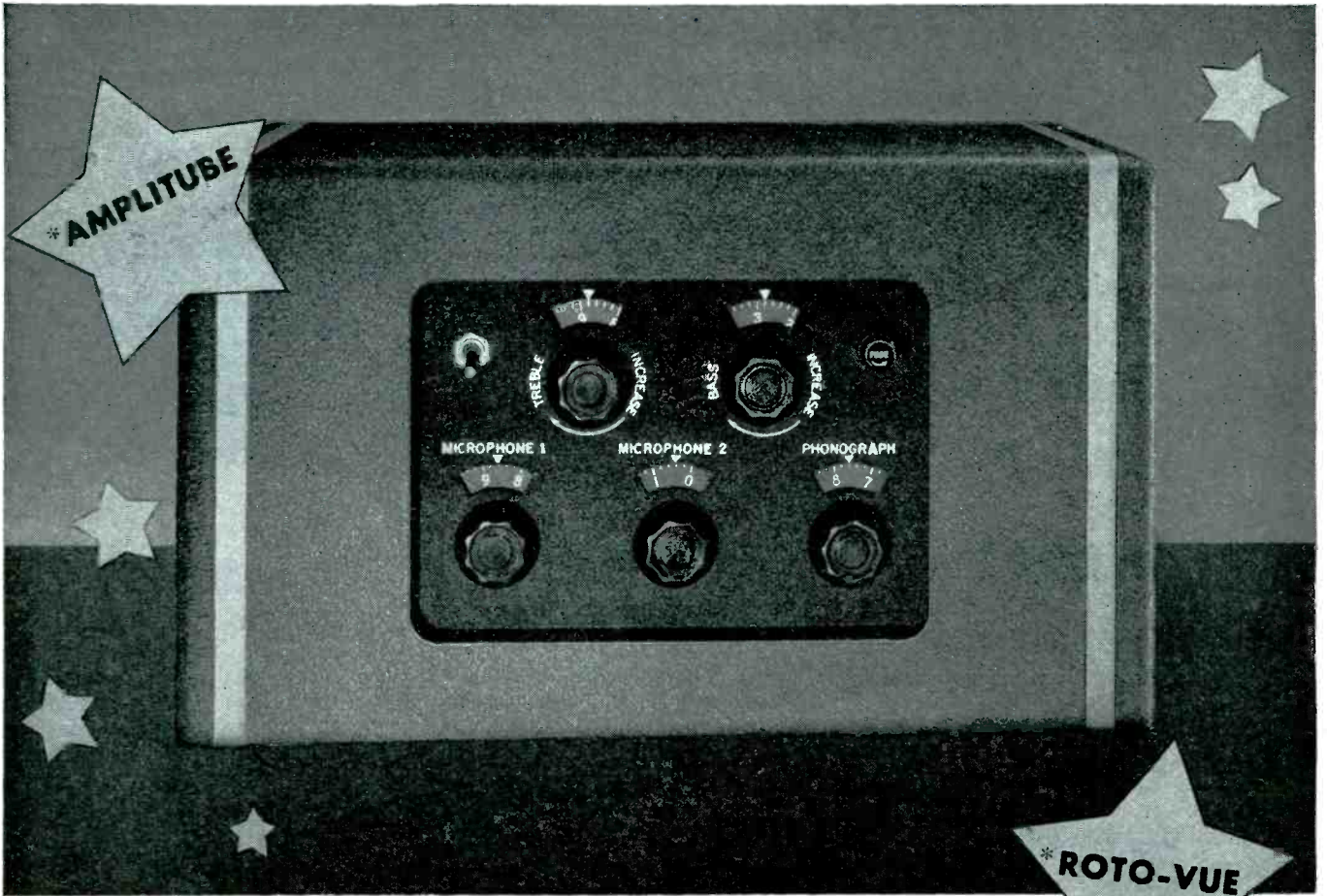

***AMPLITUDE**

***ROTO-VUE**

Ethical Engineering is the Basis of
Eastern's 21 STAR FEATURES

***UNICABLE**



Ethical engineering at Eastern is the history of many years in the service of sound amplification. The 21 Star Features are the result of intensive experience dating back to the early days of radio—the pioneer 20s! Today this engineering background accounts for the many innovations we have designed for the new 1946 Eastern Amplifiers—the 21 Star Features that produce Eastern's

famous *Quality Performance*. No other amplifiers, regardless of price, incorporate so many novel and useful features. . . . For complete information and price list—for the first edition of our 1946 Catalog—write today! . . . Eastern Amplifier Corporation, 794 East 140th Street, New York 54, N. Y. Dept. 12F.

RECESSED CONTROLS

CODED CABLE

EASTERN   **AMPLIFIERS**

*U.S. Reg'n Applied For

N-Y-T can put a finger...

ON YOUR TRANSFORMER REQUIREMENTS



★ The illustrated unit typifies the many hermetically-sealed components—transformers, chokes and filters—designed to meet unusual operating conditions for every type of application.

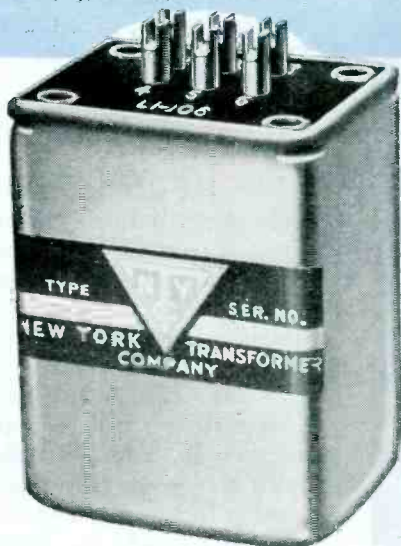

—with emphasis on electrical and mechanical suitability!

The N-Y-T Sample Department has demonstrated its ability to continuously supply advanced transformer, choke and filter designs for most electrical and electronic needs. In every instance, all requirements are fulfilled efficiently, and economically.

Let us take care of any samples you may need for new equipment being designed.

Inquiries are invited; address Dept. E

NEW YORK TRANSFORMER CO.
26 WAVERLY PLACE, NEW YORK 3, N. Y.

METAL
RUBBER
METAL

Torflex Flexible BEARINGS HARNESSES VIBRATION AND NOISE

● Three of the most destructive enemies moving parts have to contend with are vibration, noise and shock. They impair smooth operation, cut down efficiency, produce excess wear and shorten the life of any piece of equipment. Torflex Flexible Bearings were created, engineered and designed to control and eliminate vibration, noise and shock and are manufactured by Harris Products Company, pioneers in the field of engineered vibration control.

Torflex Flexible Bearings consist of a tube or ring of rubber stretched longitudinally between two concentric metal sleeves which prevent the rubber from returning to its original state. The pressure thus exerted by the rubber, on the metal sleeve, insures a high capacity mechanical bond between the rubber and metal under all operating conditions. Torflex Flexible Bearings are free from wear, also have long life, compensate for parallel and angular shaft misalignment, require no lubrication, and are widely used to transmit torque. They come in a wide range of sizes, are simple and easy to incorporate in designs and to install.

We welcome the opportunity to discuss with engineers and manufacturers the possibilities and the many advantages of Torflex Flexible Bearings in the control and elimination of vibration, noise and shock. Drop us a line today.

HARRIS
PRODUCTS COMPANY
CLEVELAND 4, OHIO

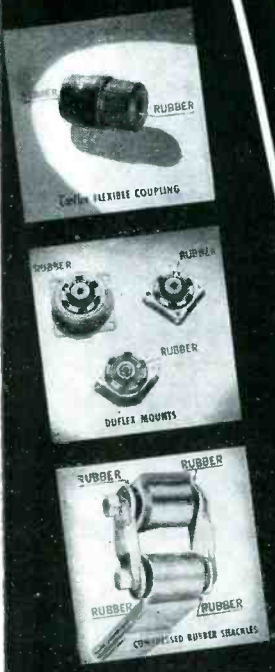

private study, the unit can be used with a pair of crystal headphones without an amplifier. A synchronous motor drives the turntable at 78 rpm. The recorder comes complete with the motor, a standard crystal pickup, spotting mechanism, 3-tube amplifier, and 5-in. permanent magnetic dynamic speaker. It weighs less than 20 lb and can be used on 110-v, 50/60 cycle ac.

Vacuum-Tube Voltmeter, Amplifier

MODEL No. 451 VACUUM-TUBE voltmeter measures amplifier gain, network response, and output level at audio and radio frequencies. It is rated 25 mv, a-c, on the lowest range, 1000 v on the highest range, and 10 cps to 700 mc frequency range, with 7 $\mu\mu\text{f}$ input capacitance. Other characteristics of



the unit include: single linear scale for all voltage and current scales; single zero adjustments for all a-c and d-c ranges; voltage regulated supply; stable operation; a rated accuracy of 2 percent of full scale values and large overvoltage capacity. The amplifier used with the voltmeter is model No. 101. Reiner Electronics Co., Inc., 132 West 25th St., New York 1, N. Y.

Tube Tester

MODEL No. 2413 tube tester provides short and open element tests, plus a transconductance comparison check for matching tubes. Three-position lever switching provides simple and speedy operation and gives individual control for each tube element. The unit has a multi-color scale and comes supplied with instructions and test charts for quick reference. The case is furnished with a sturdy handle. It measures 10 x 10 x 5 $\frac{3}{4}$ in. Triplett Electrical Instrument Co., Bluffton, Ohio.

HAVE YOU A TOUGH PROBLEM?

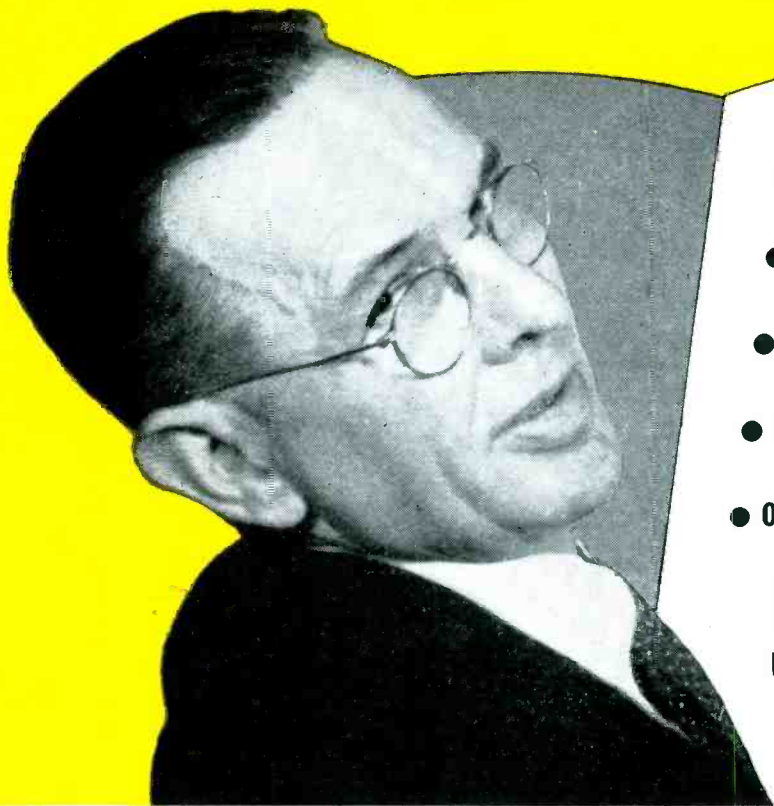

Versatile "dag" dispersions can help you with problems like these:

- Minimizing Diamond-Die Wear and Wire Breakage
- Providing Lubrication and Conductivity Simultaneously
- Producing a Non-Reflective Ray-Focusing Anode
- Obtaining a Shielding Material Which Can Be Applied Like Paint to Any Surface, Whether Rigid or Flexible

Many a man has saved a lot of money and worry by querying us about "dag" Colloidal Graphite. Maybe we can help you. Why not write us today?

"Dag" products are versatile. Dispersed in numerous liquids, they're doing a good job over a wide range of industry for regular production.

Some "dag" suspensions, hitherto not available, were developed during the war. Available for you now, they broaden the usefulness of already broadly used "dag" colloidal graphite. You too may save yourself worry and money by writing today for full information about the "dag" family of dispersions.

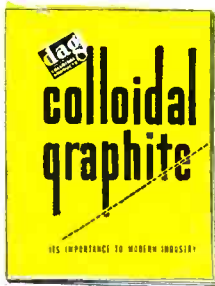

This new literature on "dag" colloidal graphite is yours for the asking:

- 430** A general booklet on the story of "dag" colloidal graphite. 12 pages profusely illustrated.
- 440** A complete list of "dag" colloidal graphite dispersions with applications.
- 421** "dag" colloidal graphite for ASSEMBLING AND RUNNING-IN ENGINES AND MACHINERY.
- 422** "dag" colloidal graphite as a PARTING COMPOUND.
- 423** "dag" colloidal graphite as a HIGH TEMPERATURE LUBRICANT.
- 431** "dag" colloidal graphite for IMPREGNATION AND SURFACE COATINGS.
- 432** "dag" colloidal graphite in the FIELD OF ELECTRONICS.

ACHESON COLLOIDS CORPORATION
PORT HURON, MICHIGAN DEPT. M-5

JMLCo A-M1

Please send me, without obligation, a copy of each of the bulletins checked:

- No. 430 NAME _____
- No. 440 POSITION _____
- No. 421 FIRM _____
- No. 422 ADDRESS _____
- No. 423 ZONE No. _____ STATE _____
- No. 431 OUR PRESENT OIL SUPPLIER IS _____
- No. 432 (Lubricants containing "dag" colloidal graphite are available from major oil companies.)



colloidal graphite

ACHESON COLLOIDS CORPORATION
Port Huron, Michigan

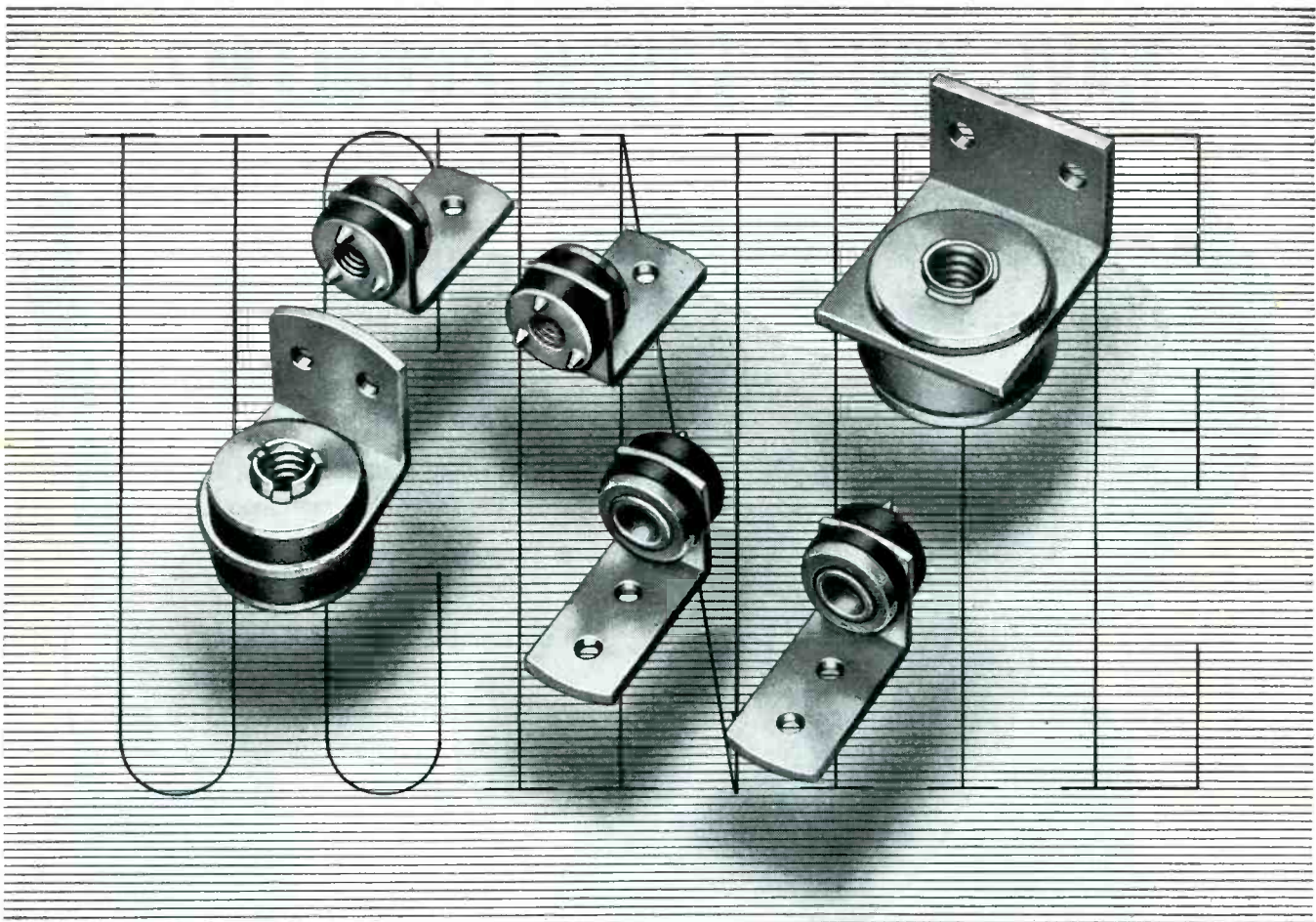

Their uses are mounting, too

These Ucinite shock mountings have a self-contained Tee Nut. Set in a synthetic rubber ring of great toughness and resilience they are extensively used as shock-proof mountings on Service radio sets. They have stood up successfully under severe tests of shock, temperature and climate.

Other industrial peacetime applications such as electrical condensers and phonograph turntables immediately suggest themselves.

The mountings shown here are only one general type of the basic design which can be adapted in a wide variety of applications for other requirements.

The UCINITE CO.

Newtonville 60, Mass.

Division of United-Carr Fastener Corp.

Specialists in **RADIO & ELECTRONICS**

LAMINATED BAKELITE ASSEMBLIES

CERAMIC SOCKETS • BANANA PINS &

JACKS • PLUGS ; CONNECTORS • ETC.



TRANSPORTATION

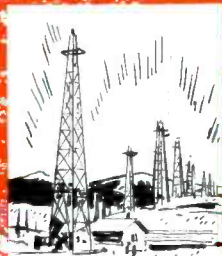

PETROLEUM

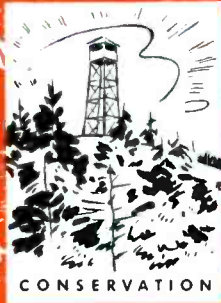

CONSERVATION



PROTECTION



MOTION PICTURES



UTILITIES



NEWSPAPERS



The New Bendix-Pacific

VHF MOBILE RADIO COMMUNICATION SYSTEMS

Bendix—famous for many recent new developments in radio for industry and home—now announces advanced VHF radio communication systems for mobile use.

The new systems, which offer greatly improved performance characteristics and economy of operation, are available for use in three of the Very High Frequency bands—30-44 megacycles, 72-76 megacycles and 152-162 megacycles.

All the equipment has been designed to use low input power. Any extended service can be provided with relay facilities.

For five years Pacific Division's radio research group has been working with military experts on advanced designs of VHF

communication and control systems, and the new equipment embodies the latest developments for commercial application. In addition to new performance characteristics, the Bendix-Pacific equipment has been designed for compactness, long life and for easier service and maintenance.

Whatever application of radio voice communication you are planning, Pacific Division is interested in explaining the advantages of the new equipment to you. Pacific Division, Bendix Aviation Corporation, 11677 Sherman Way, North Hollywood, California.

Sales Engineering offices in New York and St. Louis.



One of the new VHF communication units combining transmitter and receiver in a single cabinet for either mobile or fixed station installation.

© 1946. Bendix Aviation Corp.

Pacific Division
Bendix Aviation Corporation
COMMUNICATION SYSTEMS

PLUGS *and* JACKS

for every known application!

Built in accordance with latest Signal Corps and Navy specifications, Amalgamated Plugs and Jacks are tropicalized to make them fungus resistant, waterproof and moistureproof when called for. Insulators of these components are designed to withstand extremes of temperatures for -67°F to $+167^{\circ}\text{F}$, at humidities up to 100%. We also specialize in producing Plugs which will bear up under the high heat met in rubber molding cord sets.



PLUG PL-55 and N.A.F. 1136-1

Long sleeve, two-conductor plug, mate to Jack JK-34-A. Withstands minimum of 60 cycles AC, potential of 500 volts effective, applied between any two terminals for not less than two seconds. Meets minimum insulation value of 2000 megohms between conductors at 68°F at humidities up to 100%.



PLUG, STYLE "A"

Two-conductor, special type plug for use with Neoprene or Buna S molded cords. Same specifications as PL-55.



PLUG, STYLE "D"

Two-conductor, special type plug for use with Neoprene or Buna S molded cords. Same specifications as PL-55.



PLUG PL-204

Hand set. A special plug wherein both a modified plug, PL-55 and PL-68, are held in place by a phenolic case. Same specifications as PL-55 and PL-68.



NOTE: Amalgamated Engineers will gladly consult with you on the design and development of Plugs and Jacks for special applications—present or postwar.

JACK JK-26, N.A.F. 215284-2

Two-conductor Jack, mate to PL-54. Tropicalized. Withstands 60 cycle AC potential of 500 volts effective, applied between any two terminals for not less than two seconds. Meets minimum insulation value of 2000 megohms between conductors at 68°F , at humidities up to 100%.



JACK JK-48

Light duty, two-conductor Jack, mate to Plug PL-291 and Plug 291-A.



PLUG PL-54, PL-540, PL-354, N.A.F. 215285-2

Short sleeve, two-conductor plug, mate to Jack JK-26. Same specifications as PL-55.



VHF Broad Band Antenna

TYPE MS-105A broad-band dipole antenna operates in the range of 108 to 132 mc in aeronautical service. Anywhere in this range, and without adjustment, the antenna will match into a 52-ohm coaxial transmission line and produce no more than a 1.5 to 1 standing wave ratio. A frequency range of 100 to 156 mc can be used with a standing wave ratio of not more than 2 to 1. The field pattern of the antenna is non-directional in the horizontal

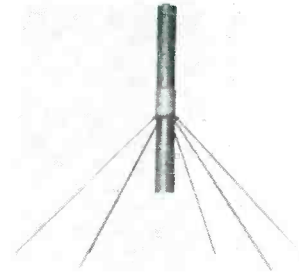

plane, and in the vertical plane is essentially the same as that of a standard dipole antenna, except that it has better frequency coverage. Polyethylene is used instead of air as a dielectric. Completely assembled, the antenna has an overall height of $38\frac{1}{2}$ in. It weighs 4 lb. 10 oz. Mounting may be either on a wood or metal mast. The connector socket located inside the tubular base will fit a standard AN-PL-259A connector plug. A standard 52-ohm type AN-8/U coaxial cable or any cable similar to this may be used with the antenna. Bendix Radio, Baltimore 4, Md.

Copper Oxide Rectifier

A NEW, FULL-WAVE copper-oxide rectifier, rated at either 12-v a-c or 50 ma d-c has been added to the line of Coprox rectifiers available from Bradley Laboratories, Inc., 32 Meadow St., New Haven 10, Conn. The new unit is actually a double unit of the manufacturer's model CX-4D4-F23, recently redesigned to handle greater capacity than the original version. The single unit is now rated at 6 v, a-c and 50 ma, d-c continuous. It mounts on a single screw, is fully enclosed and completely sealed with a special plastic compound. Pre-soldered lead wires prevent overheating during assembly.

AMALGAMATED RADIO TELEVISION CORP.

476 BROADWAY • NEW YORK 13, N.Y.

HEINEMANN

MAGNETIC CIRCUIT BREAKERS

PREVENT POSSIBLE DAMAGE

From Short Circuit or Dangerous Overload
to Blower Motors

In This AJAX ELECTRIC FURNACE



Control cabinet containing HEINEMANN three phase, 230 volt Circuit Breakers.

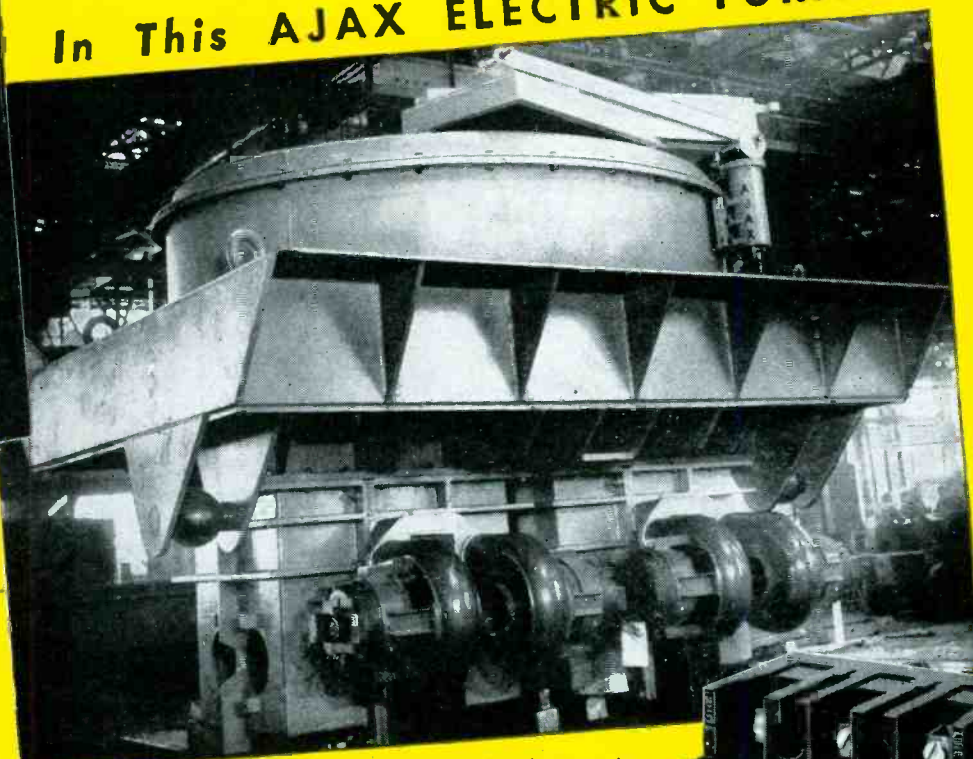

The world's largest low frequency induction furnace for melting aluminum and aluminum alloys.



Immediate and dependable protection of the blower circuits is of the utmost importance for a unit such as this 500 KW Ajax melting furnace. The Ajax Engineering Corporation, realizing the flexible but unfailing protection afforded by HEINEMANN CIRCUIT BREAKERS, included them in their specifications.

In the words of an Ajax engineer, "Protection of the blower motor against overloads and short circuits is most essential. Magnetic protection also permits quick re-cycling, which is just as important."

Although tripping *instantaneously* on short circuit or dangerous overload, the HEINEMANN Magnetic CIRCUIT BREAKER provides a *delayed trip* on minor overloads, in inverse ratio to current.

Send for NEW Catalog Showing Complete Line and Engineering Data.

HEINEMANN CIRCUIT BREAKER CO.

Subsidiary of Heinemann Electric Co., Est. 1888

97 PLUM STREET

TRENTON, N. J.



Sterling's
PLACE IN RADIO
and
ELECTRONICS

1946
THE *Sterling* MANUFACTURING COMPANY

DOWN through the years with Radio—right from the very beginning—STERLING has built specialized apparatus for the Radio market and at times—complete Radio sets for world-wide distribution . . . Millions of STERLING products,

battery eliminators, chargers, testers, have played a vital part in the development of Radio . . . Our wartime operations are now ended . . . Post-war products will reflect STERLING'S 39 years of successful electrical manufacturing experience.

The *Sterling* Manufacturing Company 9502 Detroit Avenue
Cleveland, Ohio

ELECTRICAL MANUFACTURERS FOR 39 YEARS

YOU CAN'T KEEP A COLD CUSTOMER SOLD!



BH SPECIAL TREATED FIBERGLAS SLEEVING
Tops in Electric Heaters!

- Won't Fray When Cut
- Flexible and Strong
- Non-Burning to 1200°F

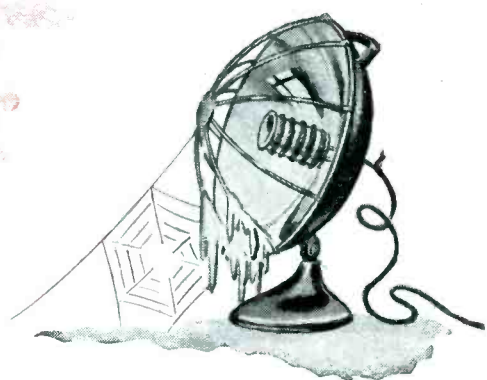

WHETHER he's Mr. Big of Industry or plain Mr. Homebody, the performance of your product's electrical insulation can make or break *his* good will, influence *your* future sales. Look at *all* the hazards of faulty or insufficient insulation. See why hundreds of manufacturers are protecting *their* products with BH Fibreglas Sleeving—the insulation that's way ahead in every important requirement, thanks to the *exclusive* BH process.

BH Fibreglas Sleeving is *permanently* flexible and non-fraying, the *original* sleeving to combine these qualities with heat resistance to

1200°F., with high tensile strength, and with resistance to moisture, oil, grease and most chemicals. It's easier to handle and install, and lasts longer in severest service. That's why BH Special Treated Fibreglas Sleeving, for instance, does a trouble-free job when the heat's on—why Mr. Room Heater Customer is sold *for good* when the heater's BH-equipped.

Whatever your product may be, if it depends on electrical insulation, you can count on one of the three BH Fibreglas Sleeveings to meet your strictest needs. Send for free BH samples *today*—test them yourself—expect surprising results!

3 GREAT BH FIBERGLAS SLEEVINGS—EACH 3 WAYS BETTER!



NON-STIFFENING*



NON-FRAYING*



NON-BURNING*



BH EXTRA FLEXIBLE FIBERGLAS SLEEVING • BH SPECIAL TREATED FIBERGLAS SLEEVING
BEN-HAR COATED FIBERGLAS SLEEVING

*Ask for sample folder giving degree above characteristics are combined in these three sleeveings.
All standard sizes and colors—available in standard 36-in. lengths and 500-ft. coils.



ALSO SLOW-BURNING IMPREGNATED MAGNETO TUBING • SLOW-BURNING FLEXIBLE
VARNISHED TUBING • SATURATED SLEEVING • A. S. T. M. SPECIFICATIONS

BENTLEY, HARRIS MANUFACTURING CO.

Dept. E Conshohocken, Penna.

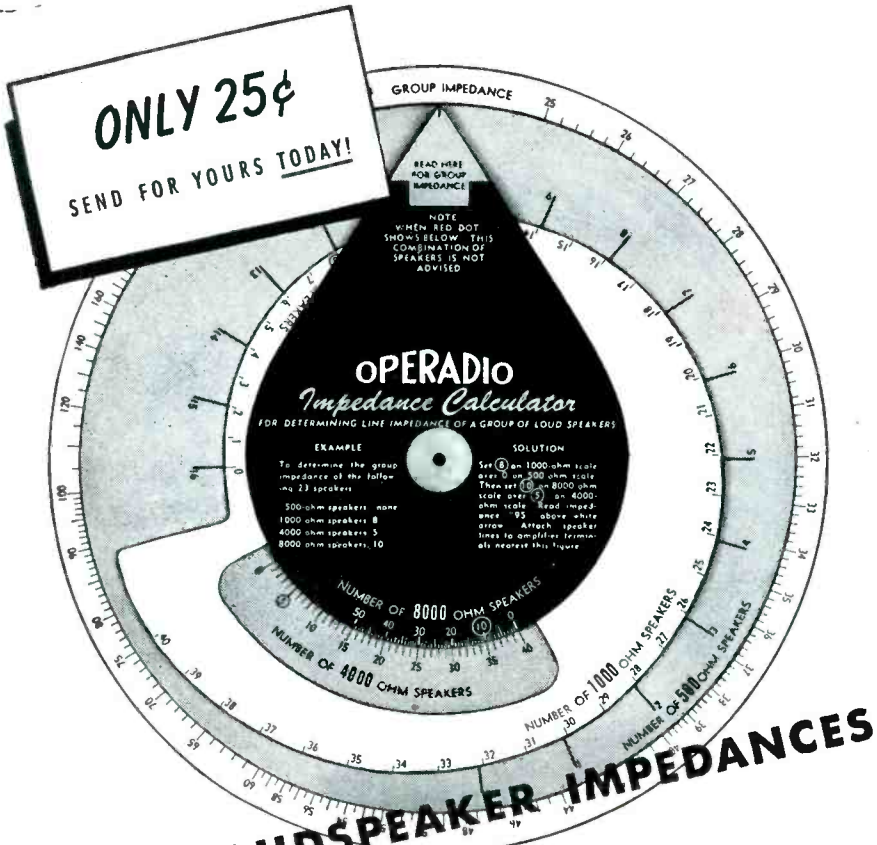

FIGURE LOUDSPEAKER IMPEDANCES IN A FLASH!

You'll save time and money on loudspeaker installations with the handy Operadio IMPEDANCE CALCULATOR...a simple twist of a disc gives you instant answers to puzzling group impedance problems! You quickly match loudspeaker lines to the amplifier for any sound system covering 500, 1000, 4000, 8000, or 16,000 ohm loudspeakers. No rule-of-thumb guesswork...no involved mathematical formulas. Handy 5" diameter, fits your pocket or sales kit. Durable card stock, coated both sides, heavily varnished. Send coupon with 25c (not stamps) today!

OPERADIO
Sound Equipment

OPERADIO MANUFACTURING CO., DEPT. E-12 ST. CHARLES, ILL.

Enclosed is 25c in coin (stamps not accepted). Send me your "IMPEDANCE CALCULATOR" by return mail.

Name _____

Address _____

City _____ State _____

Aircraft Communication Receiver

A NEW CRYSTAL-CONTROLLED, light-weight aircraft communication receiver (type 51K-1) from Collins Radio Co., Cedar Rapids, Iowa, uses the Collins Autotune for selecting the channel of operation. The receiver has ten different easily pre-selected frequencies for reception

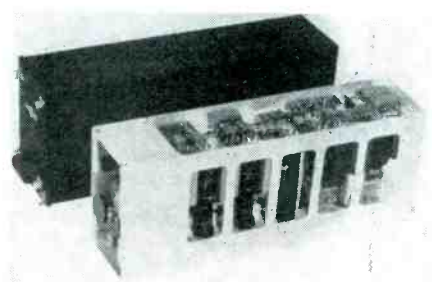

anywhere within the range of 2.4 to 18 mc. Two seconds is the maximum time required for the Autotune to change channels. The receiver is designed for commercial transport planes. It fits into 1/2 ATR unit, and weighs less than 20 lb. It operates from a 24-v d-c source. A 12-v model is also available.

D-C to A-C Converter

A D-C TO A-C ROTARY converter suitable for special applications where close control of frequency is desired is announced by Carter Motor Co., 1608 Milwaukee Ave., Chicago, Ill. Output frequency, indicated on a built-in, vibrating reed type fre-



quency meter, can be manually corrected to 60 cycles by a power rheostat connected in series with the field coil. Types of converters available include models for input voltages from 6 through 64 volts for battery conversion, and from 110 to 120 volts for line conversion with ratings from 40- to 250-w continuous duty.

RESIMENE* 803A

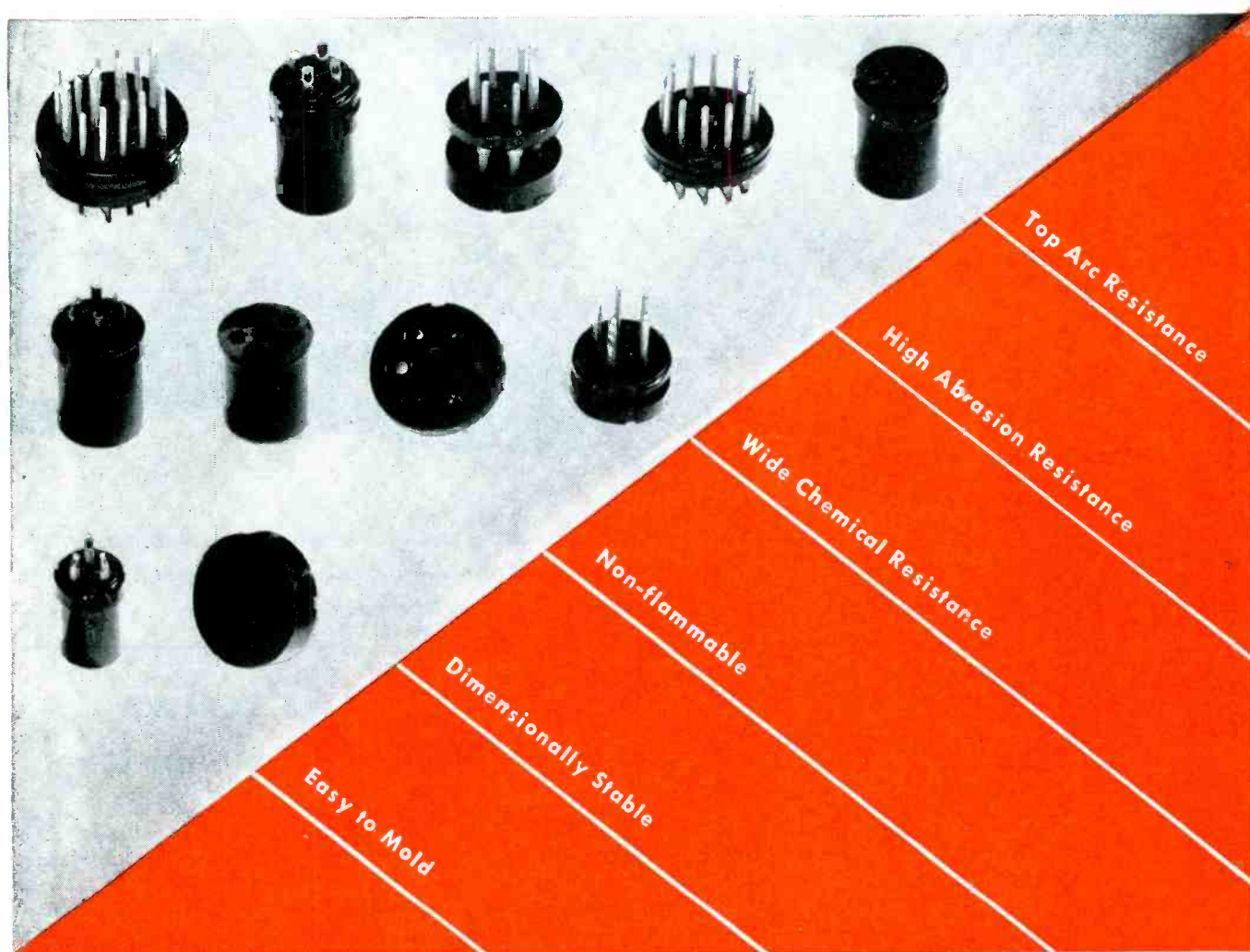

Here is a cellulose filled melamine molding compound which combines characteristics which you may need. Resimene 803A has high arc resistance—125 seconds, which means long life in any part where arcing or flash-over is met. More stamina can be built into switch bases, connectors, plugs and other electrical parts with this important advantage.

But that is not all Resimene 803A offers...its abrasion resistance is higher than cellulose filled phenolic...it has higher alkali resistance than most thermosetting plastics and, in addition, it's not attacked by weak acids,

most organic solvents or boiling water. These properties are combined in a molding compound of excellent moldability and good physical properties formerly expected only with general purpose phenolics. After-shrinkage of Resimene 803A is considerably less than any similar material... Resimene 803A is being produced only in black and olive drab.

* * *

For full details and advice, write MONSANTO CHEMICAL COMPANY, Plastics Division, Springfield 2, Massachusetts.

The broad and versatile Family of Monsanto Plastics includes: Lustron polystyrene • Cerex* heat resistant thermoplastics • Vinyl acetals • Nitron* cellulose nitrates • Fibestos* cellulose acetates • Resinox* phenolics • Thalid* far impression molding • Resimene* melamines • Forms in which they are supplied include: Sheets • Rods • Tubes • Molding Compounds • Industrial Resins • Coating Compounds • Vuepak* rigid transparent packaging material.

*Reg. U. S. Pat. Off.



He was *always* "4-FOOTED FRED"



... always down on all fours, trying to find those slithery slotted screws that skid off the driver and roll out of sight. Fred lost hours this way—as well as scores of screws—

...until AMERICAN PHILLIPS SCREWS put him back on his feet—and kept him there

Every time Fred fits an American Phillips Screw on the 4-winged bit of his power driver—he's a sure shot to make a swift, straight, secure fastening. For these recessed-head screws *stay aligned* with the driver till the heads are turned up flush. There's no open-end slot to let the driver skid out... instead, a 4-winged recess that encloses the driver completely, and holds it secure in a *tapered grip*.

So no time is lost in hunting for dropped screws... and none lost in slow starts, "drunken driving," or filing mangled

screwheads. For American Phillips Screws drive straight every time, and their heads can't burr or split. This means total time-savings up to 50%—*which means that American Phillips Screws COST LEAST on any assembly job.*

Make a note, now, to mark your orders: "American Phillips Screws." For then you get the extra value-protection of American's 4 inspections, and automatic weigh-count... plus prompt delivery from ample American warehouse stocks.

AMERICAN SCREW COMPANY, PROVIDENCE 1, RHODE ISLAND

Chicago 11: 589 E. Illinois Street

Detroit 2: 502 Stephenson Building

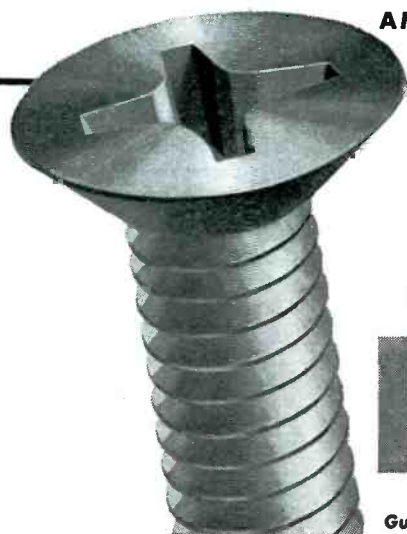

AMERICAN
PHILLIPS *Screws*

Guaranteed Free from Burrs and Split Heads



A BOLT FROM THE BLUE!

Represents a form of electricity that is hard to hold or control.

Controlling electrical currents is Formica's big job and it can do it today better than ever before. Some new developments in material and processing have provided grades that reduce high frequency losses to a new minimum, stand more arching, resist more heat.

Glass Cloth and glass mat with melamine resin have stepped up insulating efficiency, increased mechanical strength, produced a laminated material on an entirely new level of quality for many purposes.

These new materials retain the machinability and workability that always adapted laminated material to mass production. They mean better insulated electrical devices at low production costs.



FORMICA

The Formica Insulation Company • 4661 Spring Grove Avenue • Cincinnati 32, Ohio

From Design to Delivery

PEERLESS

Does it Better!

A complete transformer service—from engineering design to correctly cased unit. Peerless transformers, windings, reactors, and fluorescent ballasts are available or can be produced in sizes and capacities to meet *your* needs. Write for new catalog.

◆ **Prompt Delivery If You Order Now!**

PEERLESS

ELECTRICAL PRODUCTS CO.

6920 MCKINLEY AVENUE
LOS ANGELES 1, CALIFORNIA

Choice territories open for qualified representatives

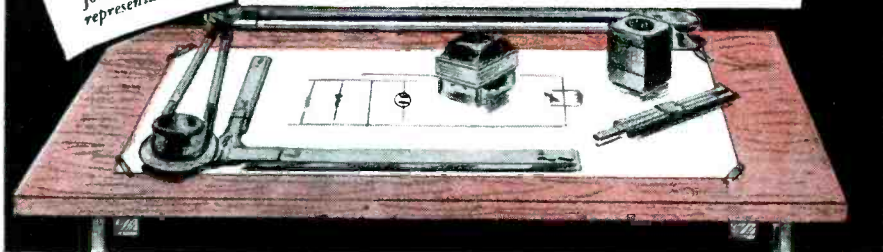

Power Supply

MODEL H (Porta-Power) provides hum-free operation of 4, 5, or 6 tube ($1\frac{1}{2}$ v) battery farm or portable radios, from 105-125 v, 50-60 cycle lines. The hum is eliminated by a two section filter composed of three capacitors of very high capacitance and two oversized iron-core chokes in the A supply; and two high capacitance capacitors and an oversized choke in the B supply. The A supply is rated 1.5 v at 200 ma; 1.35 v at 250 ma; 1.55 v at 300 ma; and 1.35 v at 350 ma. The B supply is rated 90 v at 13 ma and 101 v at 8.5 ma. The circuit is designed for optimum voltage regulation and changes in line voltages. The unit weighs $4\frac{1}{2}$ lb. General Transformer Corp., 1250 W. Van Buren St., Chicago 7, Ill.

One-Piece Coil Forms

NEW DIE-FORMED bobbin coil forms for speaker field coils come in complete, strong one-piece assemblies, ready to go on mandrels of coil winding machines. The entire coil

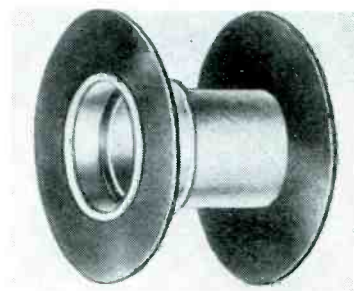

base is shaped by die in one piece from spirally wound, heat-treated dielectric materials. Precision Paper Tube Company (2023 W. Charleston St., Chicago 47, Ill.) makes these coil forms to shape, measurement and other specifications.

Phonograph Turntable

IMMEDIATELY AVAILABLE are phonograph turntable units produced by Eastern Electronics Corp., 41 Chestnut St., New Haven, Conn. Correct and uniform speed is secured through the use of a motor of ample capacity, preloaded to operate on the flattest portion of the torque-speed characteristic. Full-floating rubber mountings and rubber-cush-

OPTICAL MIRRORS and REFLECTORS

FOR ELECTRONIC, OPTICAL
AND SCIENTIFIC APPARATUS

WE specialize in the production of front or rear surface mirrors, made to your specifications. Closest optical and dimensional tolerances observed.

Because of their proven superiority, ZENITH mirrors are preferred by many leading manufacturers of precision equipment.

We invite your inquiry. Samples and quotations will be submitted promptly.

- EXCEPTIONAL REFLECTIVITY
- ALUMINUM, SILVER, GOLD, etc.
- OPAQUE OR SEMI-TRANSPARENT
- PERMANENT CHARACTERISTICS
- PROMPT SERVICE

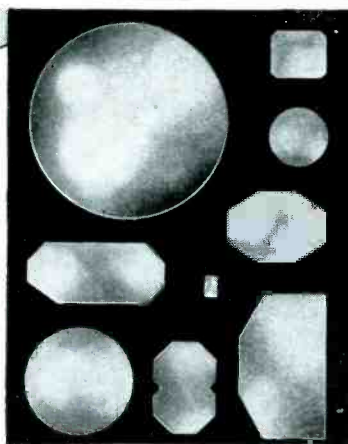

ZENITH OPTICAL LABORATORY

SPECIALISTS IN
VACUUM DEPOSITION



123 WEST 64th STREET
NEW YORK 23, N. Y.

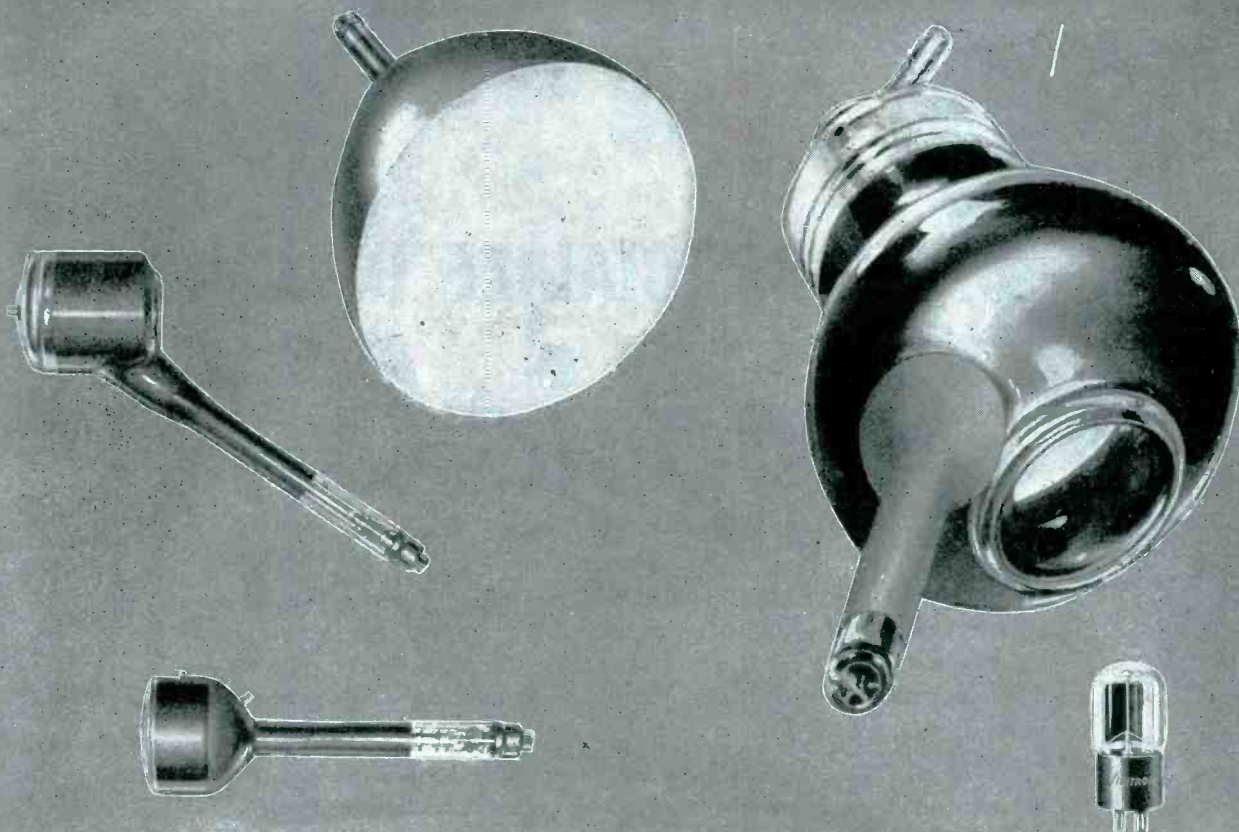

VISITRON

Television Tubes

by

Visitron is not a new name in tubes. *Visitron* is Rauland's name for all electronic tubes made in the Rauland Tube Division. It is the mark of the advanced Rauland Television thinking and planning based upon a pioneering experience second to none. Rauland *Visitron* tubes for direct-viewing for the home and projection for the home and theatre are ready to take their places in the new era of Television entertainment now unfolding before us.

To be sure of your tube, be sure it's "*Visitron*."

RADIO · RADAR · SOUND

Rauland

COMMUNICATIONS · TELEVISION

Electroneering is our business

THE RAULAND CORPORATION • CHICAGO 41, ILLINOIS



WE SPECIALIZE IN "Specials"

FOR NEARLY 20 YEARS, the Kenyon Transformer Company has done an outstanding job of satisfying the demand of large manufacturers for "special units" to fit exactly their most critical needs, with the same care that other manufacturers could provide items of their standard catalog lines.

THIS ACHIEVEMENT is a tribute to the skillful engineering ability of the Kenyon Pioneers who have maintained a leading place in the development of outstanding transformer equipment.

WE INVITE INQUIRIES from manufacturers of electronic and other types of equipment, and from industrial and commercial users of transformers.

KENYON PREDICTS that the small additional cost of "specials" will be more than offset by the superior product—streamlined to fit each manufacturer's requirement.

Inquiries invited — write for our new 1945 ILLUSTRATED CATALOG.

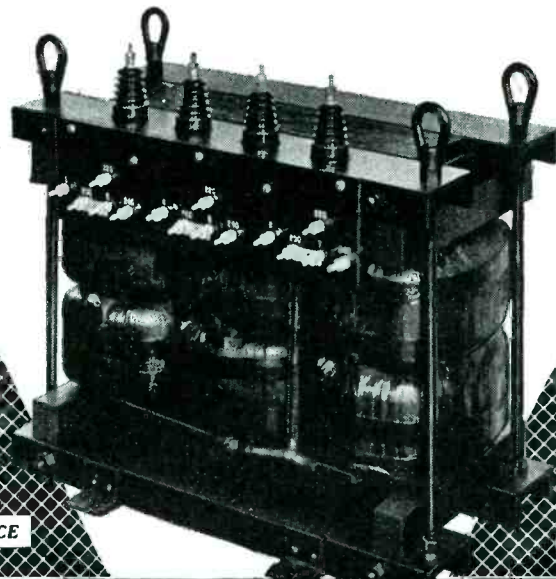

THE MARK OF

EXCELLENCE

KENYON TRANSFORMER CO., Inc. 840 BARRY STREET
NEW YORK, U. S. A.



We grew up with electronics

Our engineers and executives grew up with Electronics. Before the war we manufactured commercial radio equipment. During the war we greatly expanded our engineering and research staff and did extensive work in advanced electronics for the Army and Navy. Our present engineering and research facilities occupy more than 30,000 square feet of space. Our current production program is centered on communications equipment for rail, air, highway, marine and commercial use. Other products, notably in the field of industrial electronics, are under development. Aireon's engineering and research staff will be glad to consult with you on your electronic problems. Your inquiry will have prompt attention.

Aireon

MANUFACTURING CORPORATION

Radio and Electronics • Engineered Power Controls

NEW YORK • GREENWICH • CHICAGO • KANSAS CITY • OKLAHOMA CITY • BURBANK • SAN FRANCISCO

ELECTRONICS — December 1945

211

FOLLANSBEE SILICON STEELS

help keep performance
in line with design

Follansbee Electrical Sheets and Strip possess excellent physical properties. Punching and shearing quality is in the highest ratio to silicon content . . . width and gauge are to the closest tolerances . . . surface finishes and space factors meet exacting specifications.

And—equally important—Follansbee silicon steels are made to provide the precise magnetic characteristics required. That's why it will pay you to check with Follansbee for Electrical Sheets or Strip—silicons that help keep the performance of your products in line with their design.

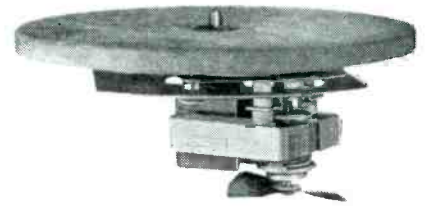

ioned drives are designed to assure quiet operation. The motor of these turntables is fan-cooled and will operate continuously with low temperature rise. All bearings are of proper size and are provided with self-lubricating features.

Stabilized Rectifier

TYPE TRX-4 STABILIZED rectifier is for telegraph and similar services. The dynamic voltage regulation characteristic of the unit is such that the load current may be varied between zero and maximum at any demand frequency, with negligible variation in terminal voltage. The unit utilizes type TRX circuit which compensates for normal variation in a-c supply voltage to the rectifier

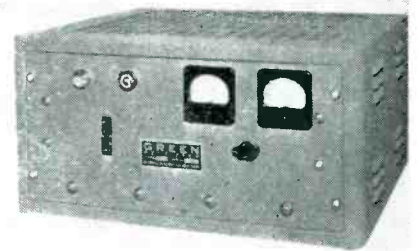

unit. Other features of the unit include: completely non-resonant filter; optional connection to 115- or 230-v, 50/60 cycle a-c supply; optional output ranges of either 110/120 or 150/160 v; circuit breaker switch protection on a-c side; voltmeter, ammeter, and supervising lamps; and facilities for mounting in standard 19-in. panel cabinets. Models are available for 1-, 2-, 4- and 7-amp capacity. Green Electric Co., Inc., 130 Cedar St., New York, N. Y.

Vibration Pickup

DEVELOPED TO MEET the requirements of aircraft engine testing, this pickup has exceptional durability under conditions of extreme vibration, high output signal level, freedom from frictional effects, limiting response at low amplitudes,

FOLLANSBEE STEEL CORPORATION

GENERAL OFFICES • PITTSBURGH 30, PA.

Sales Offices—New York, Philadelphia, Rochester, Cleveland, Detroit, Milwaukee.
Sales Agents—Chicago, Indianapolis, St. Louis, Kansas City, Nashville, Houston, Los Angeles, San Francisco, Seattle; Toronto and Montreal, Canada.

Plants—Follansbee, W. Va., and Toronto, Ohio



COLD ROLLED STRIP • ELECTRICAL SHEETS & STRIP • CLAD METALS
POLISHED BLUE SHEETS • SEAMLESS TERNE ROLL ROOFING

First in Circuit Protection

LITTELFUSE

3 AG and 3 AB Fuses

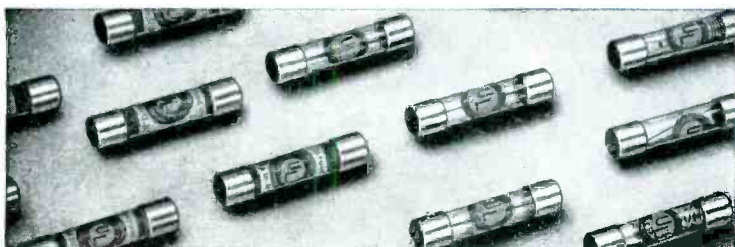

Littelfuse, the first manufacturer to receive Underwriters' Approval on glass-enclosed fuses in current ratings over 3 amps at 250 volts NOW has Underwriters' Approval on fibre-enclosed fuses from 10 amps to 20 amps at 250 volts.

These 3 AB "TINY MIGHTY" fuses (1/4x1/4 dia.) will take the place of bulky cartridge or plug fuses and mountings used in heavy-duty electric appliances, power supplies, amplifiers, communications and electronic equipment, radio, motor circuits, etc. To reduce fusing space and weight get approved protection with 3 AG and 3 AB "TINY MIGHTY" Littelfuses.

Ranges of Underwriters' Approved 3 AG Littelfuses, 1/16 amp to 8 amps inclusive; Underwriters' Approved 3 AB "TINY MIGHTY" Littelfuses, 10 amps to 20 amps inclusive at 250 volts or less.

LITTELFUSE INCORPORATED
4757 N. Ravenswood Ave., Chicago 40, Illinois

QUALITY SERVES

Quality is built on the firm foundation of unselfish service. Before men can desire to build quality into their work, they must first desire to serve their fellow men well. Mediocre and inferior men build quality through pressure of competition or fear of censure. Leaders of men give and maintain quality because in so doing they render the kind of service they believe is worthwhile, and because they desire the satisfaction, recognition and rewards their leadership merits. Not the least of these satisfactions is the improvement of standards in those who must follow the leader.

True service demands the best quality.

President

LITTELFUSE



Incorporated

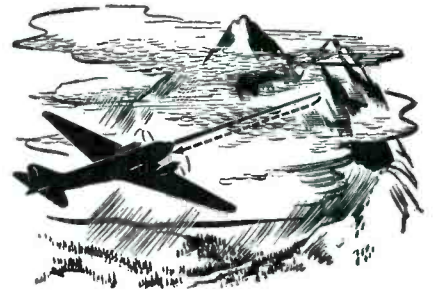
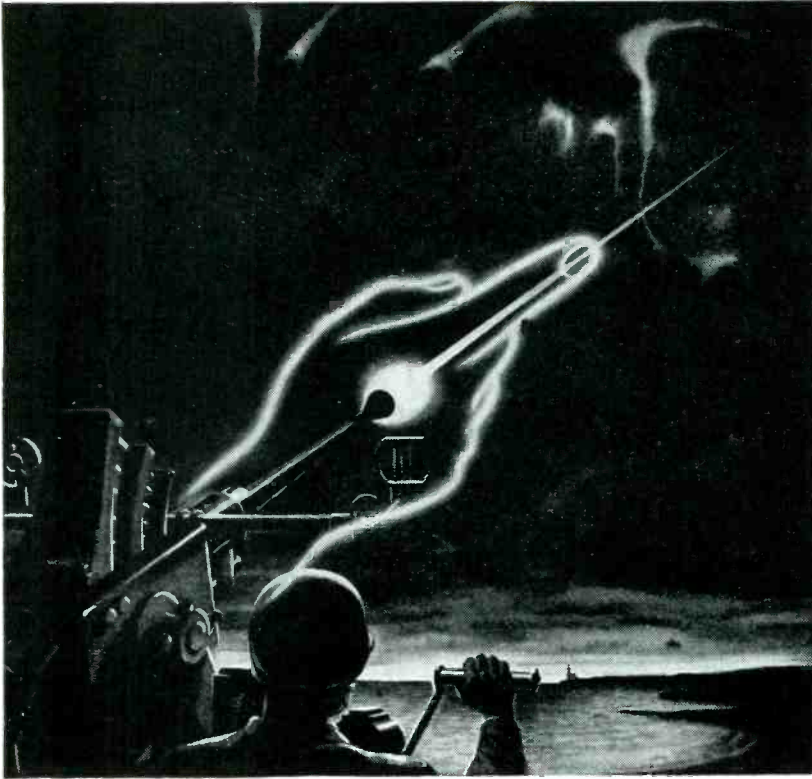

Points the way through cloud-hidden mountains

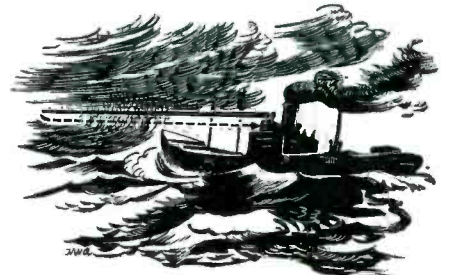

Points the way through fog-bound shipping lanes



Points the way for safe blind landings

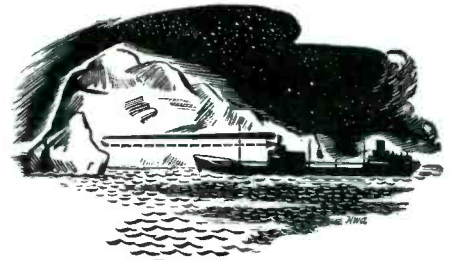

Points out night-shrouded icebergs

In War or Peace NICKEL *helps* RADAR POINT THE WAY

Nickel plays an important role in radar.

The tell-tale stream of electrons is fed to the cathode-ray screen from a pure Nickel cathode. *That's practically "standard" in all radar equipment.*

No other commercial metal offers so favorable a combination of electrical and electronic properties . . . plus the ability to be worked in such small sizes.

The multiple advantages of Nickel and high-Nickel alloys make them particularly useful in many additional radar and other still-secret applications where strong, corrosion-resistant materials are needed with special electronic or electrical properties. Send for your copy of "Nickel in the Radio Industry." The International Nickel Company, Inc., 67 Wall Street, New York 5, N. Y.



"Electron-hatching" cathodes and other elements are produced in endless variety from Nickel strip and seamless Nickel tubing. In all types of electron tubes, Nickel is regularly used for these reasons: High strength and rigidity . . . High mechanical properties and resistance to oxidation at high temperatures . . . Resistance to rusting and corrosion . . . Low gas content . . . Good working qualities . . . Required electrical and electronic characteristics.

Photo, courtesy of Superior Tube Company, Norristown, Pa.

NICKEL  ALLOYS

MONEL* • "K" MONEL* • "S" MONEL* • "R" MONEL* • "KR" MONEL* • INCONEL* • NICKEL • "L" NICKEL* • "Z" NICKEL* • Sheet • Strip • Rod • Tubing • Wire • Castings • Welding Rods (Gas & Electric)
*Reg. U. S. Pat. Off.

Almost no limit to what you can duplicate with this NEW BRUNING Photographic Printer!

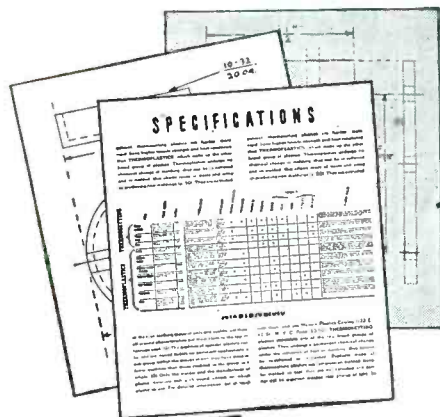
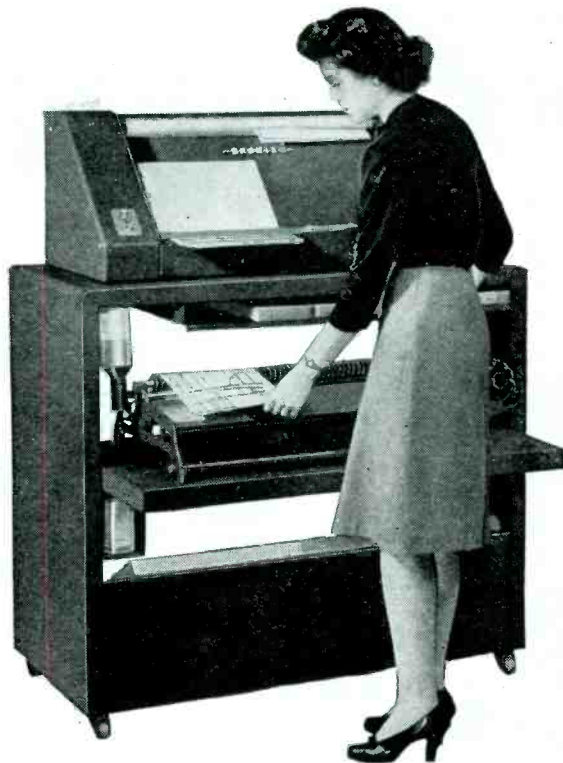

TRACINGS
LINE DRAWINGS
SPECIFICATIONS

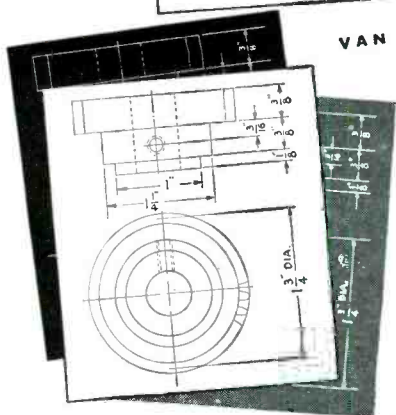

VAN DYKE NEGATIVES

BLACK AND WHITE PRINTS

BLUE PRINTS

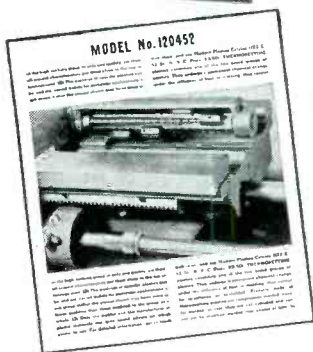

ILLUSTRATIONS

• Now you can use this new *photographic* reproduction process right in your own drafting room or engineering department! With the Bruning Model 2 BW and Copyflex Continuous Printer, there is practically no limit to the kind of materials you can duplicate! You can have copies of anything typed, printed, illustrated or drawn. Original material with copy on both sides can be reproduced from one or both sides.

Both Copyflex photographic and BW Black and White sensitized materials are exposed on the Model 2 Printer. Copyflex prints are developed with three trays and a simple drier (readily available). BW prints are developed in the Model 153M developing machine, combined in a convenient stand with the printing unit. Moderately priced, the Model 2 Printer and 153M Developer increase your duplicating scope — provide a wider range of duplicating advantages. Mail the coupon for literature about this modern print-making method.

CHARLES BRUNING COMPANY, INC.

Since 1897

NEW YORK

CHICAGO

LOS ANGELES

Atlanta
Kansas City
St. Louis

Boston
Milwaukee
San Francisco

Detroit
Newark
Seattle

Houston
Pittsburgh

CHARLES BRUNING COMPANY, INC.
4712-24 Montrose Avenue, Chicago 41, Illinois
Please send me complete information on your Model 2 BW and Copyflex Continuous Printer—and on other Bruning printing and developing machines for making Bruning Black and White Prints.

Name.....
Company.....
Street.....
City..... State.....

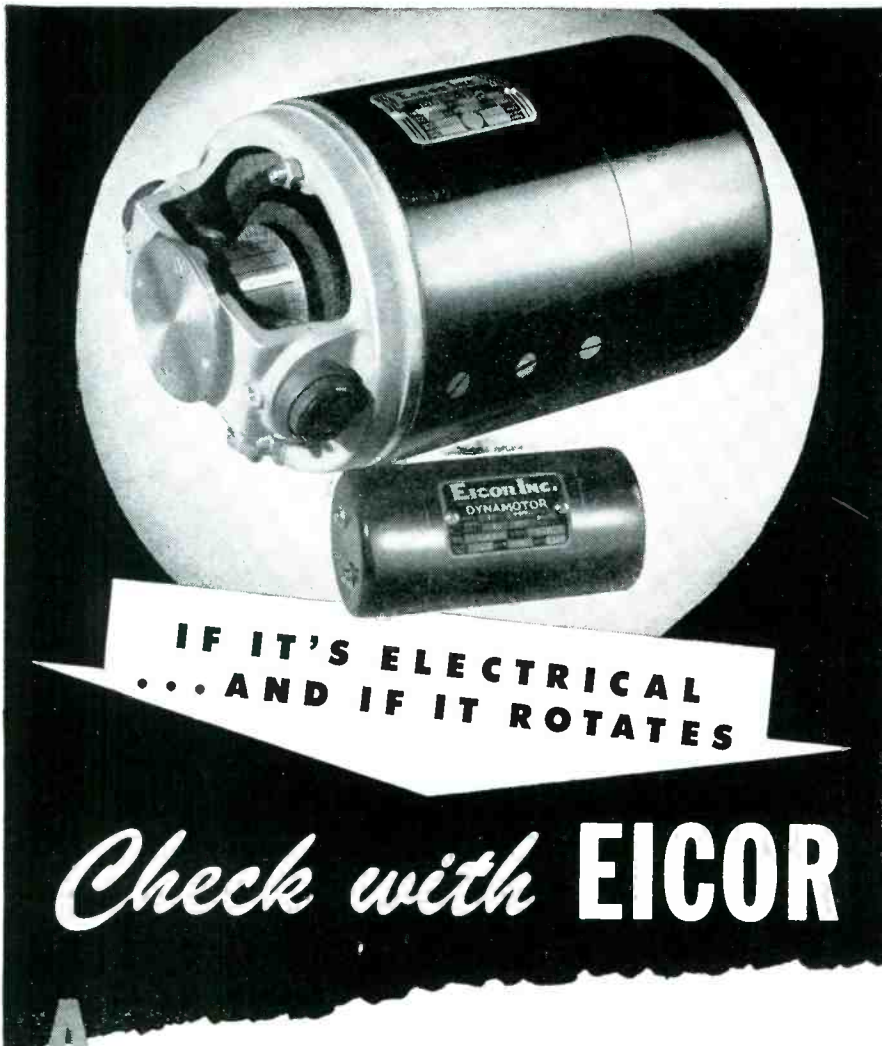

Check with **EICOR**

A roster of all Eicor products, in their various types and sizes, shows an astonishing number and diversity. But of special interest to users of rotary electrical equipment is our ability to produce units unusual in design or performance . . . and do it quickly, accurately, and at reasonable cost.

Serving in an endless list of special applications, these developments include . . . the smallest commercially produced dynamotor, for 10 watts continuous output, in a 2-5/16" diameter frame and weighing only 34 ounces . . . a motor rated 1/5 hp at 3800 rpm for intermittent duty, 2-5/16" in diameter, weight 38 ounces . . . an aircraft inverter to supply output of 100 va, 400 cycle, single or three phase, in a 3" frame and unit weight of 5 3/4 lbs. . . a .6 hp, 4000 rpm, intermittent duty motor, 4" in diameter and 9 1/2 lbs. weight . . . a dynamotor 4-1/16" in diameter which supplies 32 watts continuous output per pound weight . . . a 12 vdc motor rated 1/4 hp at 1700 rpm with 150 in. lbs. lock torque in a 5 1/4" frame.

These highlights are an indication of what EICOR has done in the past. In the days to come our creative engineering will solve similarly difficult problems involving motors, dynamotors, and generating equipment for industry. Your inquiry is invited.



EICOR, INC. 1501 W. Congress St., Chicago, U. S. A.
DYNAMOTORS • D. C. MOTORS • POWER PLANTS • CONVERTERS
 Export: Ad Auriema; 89 Broad St., New York, U. S. A. Cable: Auriema, New York

and stability of calibration over wide temperature ranges. Output is proportional to vibratory velocity, with uniform response from below 10 cps to approximately 1000 cps, and usable response to 4 cps. The pickup is usually operated as a seis-



mic instrument, but can be furnished with facilities for direct attachment of a light moving coil to the structure whose vibration might be influenced by a heavier mass. Pickups are supplied with a special flexible pigtail lead, and are easily and quickly converted for use in either horizontal or vertical planes without affecting calibration. The MB Manufacturing Co., Inc., New Haven, Conn.

Screw-Type Iron Cores

BECAUSE THESE IRON cores utilize threaded cores they are designated as Screwtype molded iron cores. No brass core screw is necessary for their adjustment. There is no metal

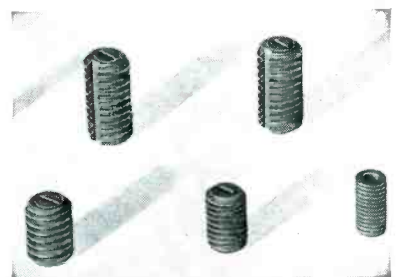

in the field of the coil and the cores themselves are not grounded. As a result a higher Q is obtained. Stackpole Carbon Co., St. Marys Pa.



A transmitter-receiver made by Bendix is completely interchangeable with British equipment.

More than 7,900 watts of power are used by the 435 vacuum tubes in the radio equipment of a B-29.

Relays

BY

LEACH

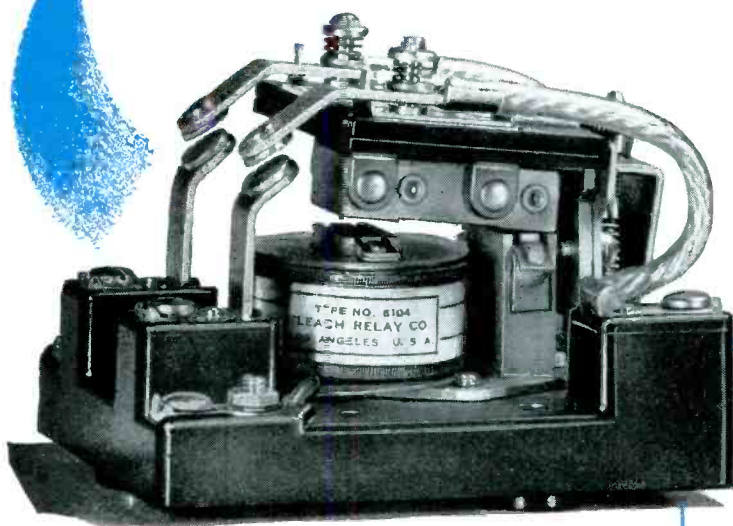

THE NEW 30 AMPERE RELAY

- ✓ Moulded bakelite base.
- ✓ Laminated core and armature
- ✓ Low temperature rise
- ✓ $\frac{3}{8}$ inch wiping contacts
- ✓ Rated 30 Amps. at 110 V.A.C.
- ✓ Rated 20 Amps. at 220 V.A.C.

● *All the engineering skill that has created for Leach its reputation as manufacturers of fine relays is at your service. Our Engineering Department will be glad to discuss with you any problems which you may have. Write for literature.*



LEACH RELAY CO.

5915 AVALON BOULEVARD, ★ LOS ANGELES 3, CALIF.

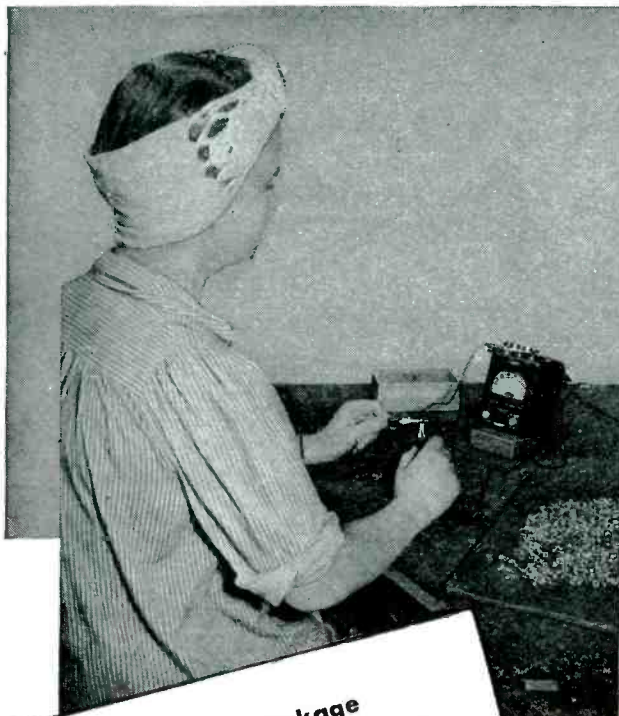

*Now... Leakage
Resistance Measurements
at Low Potentials!*



Weston

MODEL 799

INSULATION TESTER

• 10 BILLION Ohms •

will measure:

- ✓ Insulation Properties
- ✓ Resistance Leakage
- ✓ Conductivity of Insulating Materials
- ✓ Leakage due to Moisture Absorption
- ✓ Readings — .1 to 10,000 megohms

Because of its compactness and extreme high sensitivity, this direct reading instrument fills an important measurement gap in the production and servicing of a wide variety of components and electrical devices. Minute faults can be detected in advance . . . tests can be made without destructive breakdown. Test potential less than 50 Volts.

Here's what a few typical users say about Model 799:

"We use it for testing the leakage between windings in transformers, or from windings to core or case."

"We can test the leakage of low voltage paper and mica condensers with the 799, and without danger of damaging the dielectric."

"We test leakage resistance between individual wires in cable harnesses."

"Model 799 is also ideal for checking leakage due to moisture in fiber terminal strip."

For complete data on Model 799 Insulation Tester, communicate with the WESTON representative in your locality, or write...Weston Electrical Instrument Corporation, 618 Frelinghuysen Ave., Newark 5, N.J.

Weston Instruments

ALBANY • ATLANTA • BOSTON • BUFFALO • CHICAGO • CINCINNATI • CLEVELAND • DALLAS • DENVER • DETROIT • JACKSONVILLE • KNOXVILLE • LOS ANGELES • MERIDEN
MINNEAPOLIS • NEWARK • NEW ORLEANS • NEW YORK • PHILADELPHIA • PHOENIX • PITTSBURGH • ROCHESTER • SAN FRANCISCO • SEATTLE • ST. LOUIS • SYRACUSE

In Canada, Northern Electric Co., Ltd., Powerlite Devices, Ltd.

*they're made with a **WALLOP!***

Just a single stroke of an impact extrusion press makes shields like these of Alcoa Aluminum. They are made with a wallop and they carry a wallop, too.

They are lightweight, nonmagnetic, resistant to corrosion. They can be produced at high speed with accurate dimensions maintained.

New developments in impact extrusions make possible new and unusual shields of Alcoa Aluminum. Often lugs, bosses and ribs can be included in this single stroke operation.

Let us help you find out what shields of Alcoa Aluminum can do for your own electronic equipment. ALUMINUM COMPANY OF AMERICA, 2136 Gulf Bldg., Pittsburgh 19, Penna.

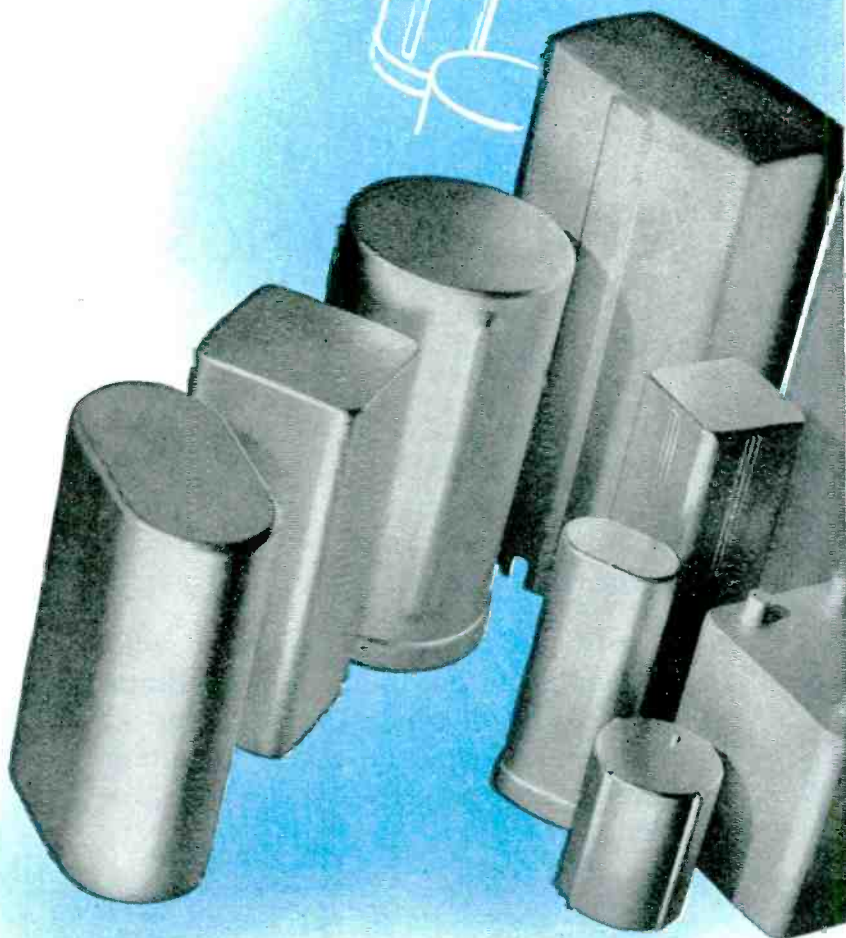

ALCOA **FIRST IN**
ALUMINUM





No. 6 of a Series

MODERN COIL WINDINGS

**Partial View of
Automatic Coil Winding Department**

Coto-Coil Electrical Coil Windings have pioneered in the industry since its infancy. Coto-Coil engineering skill and products have met all demands of two world conflicts and the intervening years of peace.

Now, in a modern plant, equipped with every facility for producing coil windings which may be depended on to meet all requirements, Coto-Coil is busy meeting the increasing demands of peacetime production.

**Our 28 years of experience in coil design
and production are at your service.**

COTO-COIL CO., INC.

COIL SPECIALISTS SINCE 1917

65 PAVILION AVE.

PROVIDENCE 5, R. I.

Literature

Frequency Meters. Bulletin No. 1770 supersedes this manufacturer's bulletin No. 1695. The newer edition contains sixteen pages and is illustrated with photographs and diagrams of switchboard, portable and miniature types of Frahm vibrating-reed frequency meters. A variety of special models are included. Meters are available on ranges as low as 15 cps up to 400 cps. Higher ranges are available on special order. An explanation of the resonant reed principle and vibrating-reed characteristics as well as how to read the scale are given. James G. Bidle Co., 1211 Arch St., Philadelphia 7, Pa.

Modified Schering Bridge. New photographs, photo-diagrams and explanatory material are included in a recently issued catalog, E-54 (2) which gives the characteristics and advantages of this direct-reading modified Schering bridge for use in the measurement of dielectric constant and power factor of a dielectric in solid or liquid form. Leeds & Northrup Co., 4934 Stenton Ave., Philadelphia 44, Pa.

Vibration Test Equipment. L.A.B. Corporation, 31 Union Place, Summit, N. J. produced an 8-page loose-leaf bulletin which describes and illustrates three different types (VU-DM-100, VU-DM-500 and RV-3) of three and two-dimension vibration tests equipments for laboratory and production usages.

Electronic Counter. A 16-page bulletin illustrates and thoroughly describes Model No. 67, two-decade electronic counter for high-speed counting. This instrument is one of the adaptations of the Potter standard electronic counter-decade. Potter Instrument Co., 136-56 Roosevelt Ave., Flushing, N. Y.

DZUS



SPIRAL CAM FASTENERS SERVE THE ELECTRONIC INDUSTRY

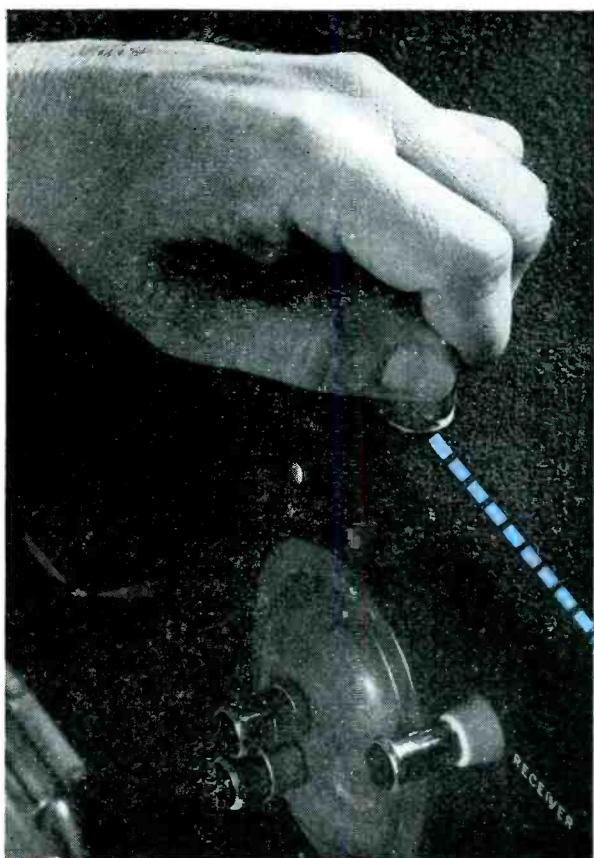

Just a quarter turn with a coin or screw driver and — click — the Dzus spiral cam fastener is firmly locked or quickly unfastened.

Navy's New Collins Autotune Transmitter — the versatile radio used on most two-place and larger types of naval aircraft — is equipped with flush head type Dzus spiral cam fasteners.

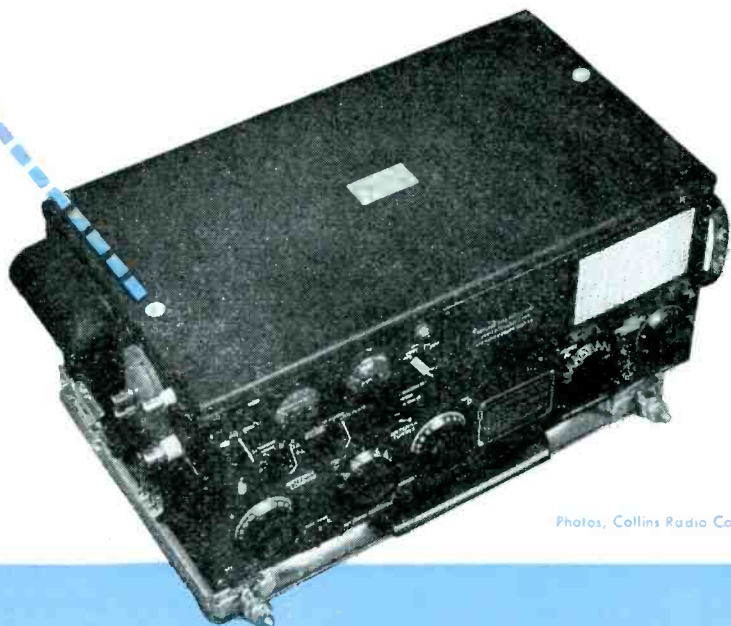

Photos, Collins Radio Co.



Flush head fastener stud



Grommet



Spring



Cut-away view of complete Dzus spiral cam fastener assembly

Radio and electronic manufacturers find that quick-acting Dzus spiral cam fasteners have all the qualifications to meet rigid specifications and requirements for firmly holding hinged or removable parts. This fastener is light but rugged, vibration-proof and permanently attached. It is easy to install and operate. It saves valuable time, especially with equipment that requires periodic inspection and adjustment.

There is a Dzus spiral cam fastener for every requirement in the electronic industry — supplied in various sizes and head styles. Send for the Dzus catalog today — and have at your fingertips the most complete line of self-locking fasteners available.

* The word DZUS is the registered trade mark of the Dzus Fastener Company, Inc.

DZUS FASTENER COMPANY, INC.

BABYLON

NEW YORK

IN CANADA: RAILWAY AND POWER ENGINEERING CORP., LTD.

POSTWAR TRANSFORMERS

BY FOSTER

Facilities for peacetime manufacture of transformers are already available at A. P. Foster, and, as war commitments are filled, will be increasingly at your service.

During the war years A. P. Foster has supplied thousands of custom-designed and custom-built transformers to all branches of our armed services, for use in all parts of the world under great extremes of climatic condition.

High production schedules have been maintained by advanced Foster manufacturing techniques. High standards of performance were demanded, achieved and will be maintained—to the benefit of America's peacetime economy.

As your own reconversion plans advance from the conference stage to the blueprint stage, it may well be worth your while to bear in mind that Foster engineers and designers are ready now to consult with you on every transformer problem and to furnish estimated costs and delivery schedules on experimental or quantity production of standard transformers or special jobs custom-built to your own specifications.

- BOB REID, 810 West 57th Street, Indianapolis 5, Ind., Telephone Broadway 2725
- BAUMAN AND BLUZAT, 2753 West North Avenue, Chicago 47, Ill., Telephone Humbolt 6809-10-11-12
- THE A. P. FOSTER COMPANY, BARRITT BORDER, 11 W. 42nd St., New York 18, N. Y., Telephone PENnsylvania 6-9113

SPECIALISTS IN BUILDING TRANSFORMERS SINCE 1938

A. P. FOSTER COMPANY

TRANSFORMER ENGINEERS & MANUFACTURERS

719 WYOMING AVENUE, LOCKLAND 15, OHIO (SUBURB OF CINCINNATI)

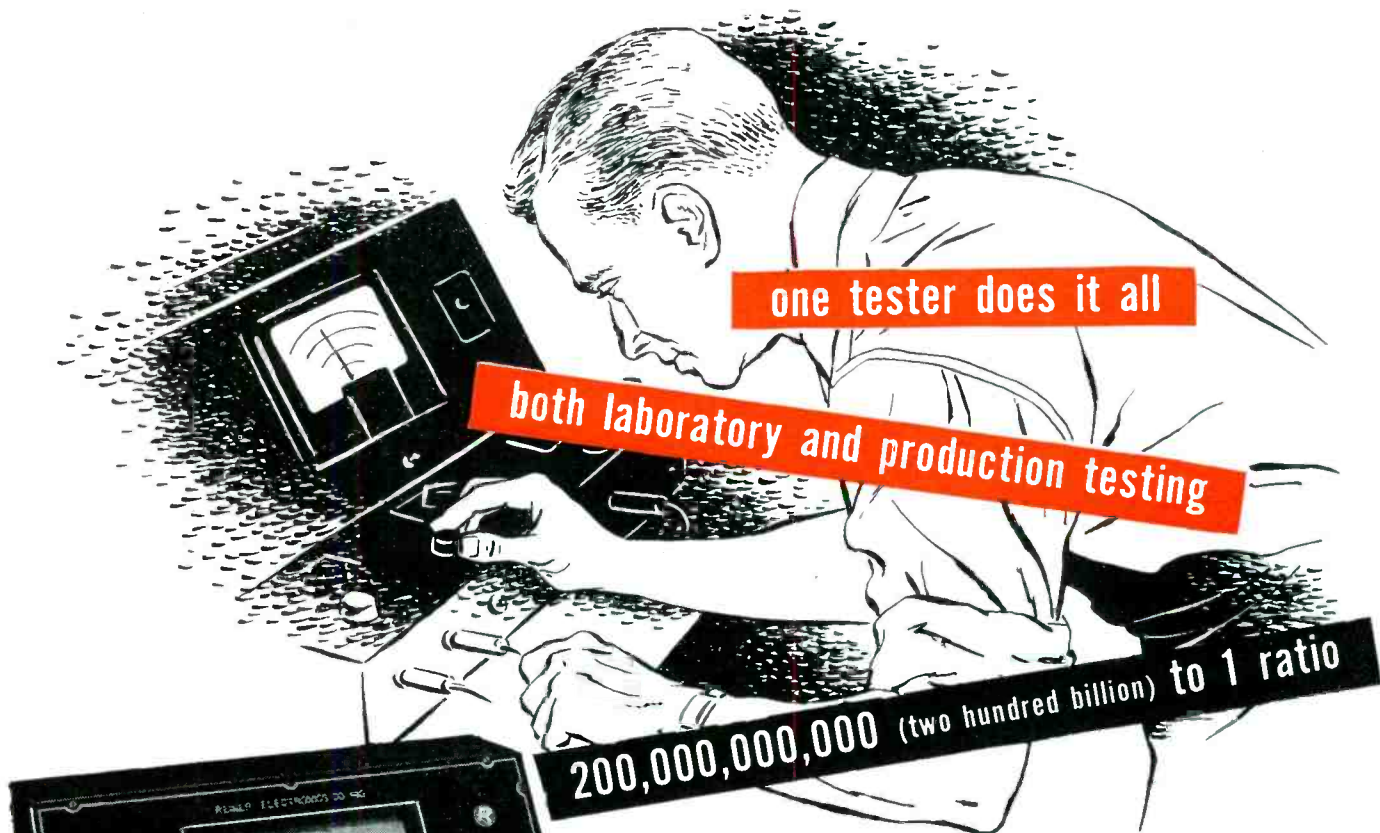

one tester does it all

both laboratory and production testing

200,000,000,000 (two hundred billion) to 1 ratio

in available resistance measurements

REINER MODEL 456 COMPREHENSIVE MASTER TESTER

The highly accurate and efficient Reiner Master Tester combines in one compact unit an unusually large number of measurements and ranges — equivalent to 61 individual single range meters. It is an electrical measurements laboratory, especially designed for industry, with *eight* types of testers in one instrument:

- | | |
|----------------------|---|
| 1. INSULATION TESTER | 5. D. C. VOLTMETER |
| 2. CAPACITY METER | 6. A. C. AMPERE METER |
| 3. OHM METER | 7. D. C. AMPERE METER |
| 4. A. C. VOLTMETER | 8. IMPEDANCE-INDUCTION METER
(with charts) |

Insulation testing at 500 volts to 10,000 megohms; at 1,000 volts to 20,000 megohms. ★ Capacity measuring one micro-microfarad to 1,000 microfarads. ★ Resistance measurements 0.1 to 1,000 megohms.

SIMPLE OPERATION: wide scales on the 9" rectangular meter permit direct, easy reading.

RANGES A. C. Current 6-15-30-60-150-300-600-1500-3000-6000-15000-30000 M. A. ★ D. C. Current 6-15-30-60-150-300-600-1500-3000-6000-15000-30000 M. A. ★ A. C. Volts 3-6-15-30-60-150-300-600-1500-3000-6000 ★ D. C. Volts 6-15-30-60-150-300-600-1500-3000-6000 ★ Ohms 0-1000-10000-100000-1 meg-10 meg-100 meg-1000 meg ★ Insulation Tests 500 volt/0-10000 megohms; 1000 volt/0-20000 megohms ★ Capacity High 5-2000 .5-200 .05-20 .005-2 .00005-.02 microfarads ★ Capacity Low 1-100 microfarads ★ Frequency range without probe A. C. volts 10 cps - 100 K. C., 25 microfarads input capacity. With probe provided 10 K. C. - 500 M. C., 1 microfarad input capacity.

SIZE: 16" x 12½" x 15" **WEIGHT:** 33½" lbs.
Delivered complete ready to use, with set of high voltage leads, set of shielded test loads, high frequency probe.

For further information on this and other Reiner precision equipment write to REINER ELECTRONICS Co., 125 W. 25 St., New York 1, N. Y.



Reiner

ELECTRONICS

Industrial Condenser Corporation's NEW HOME

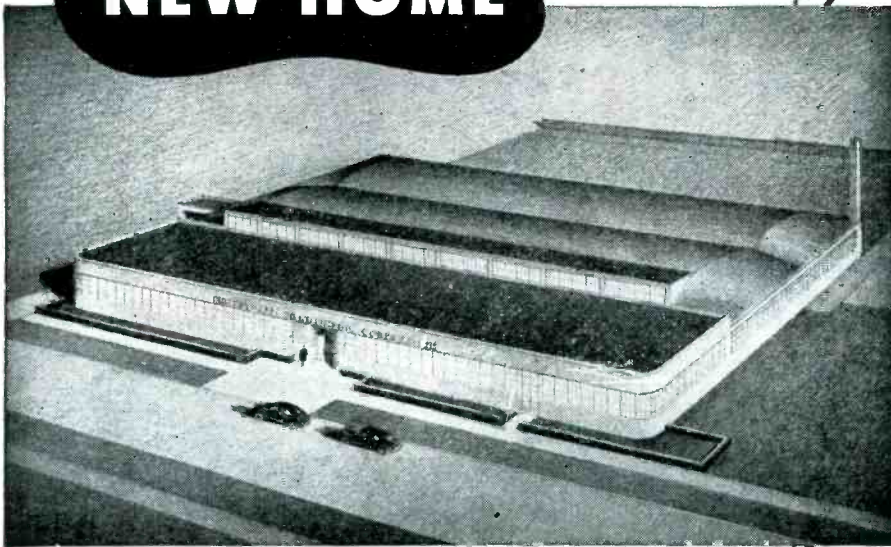

THE WORLD'S MOST MODERN CONDENSER PLANT with these outstanding features

- ★ 1,000,000 VOLT RESEARCH LABORATORY
- ★ VERY LATEST PRODUCTION EQUIPMENT
- ★ SPECIALIZED WAR-LEARNED TECHNIQUES

From this NEW ultra-modern factory come capacitors carefully engineered and accurately produced. Staffed by skilled engineers and backed by 16 years of technical progress, Industrial Condenser Corp. is supplying capacitors for every application. If your specifications call for Electrolytic, Paper, Oil, or Motor capacitors, look to Industrial Condenser Corporation.

INDUSTRIAL CONDENSER CORPORATION

3243-65 NORTH CALIFORNIA AVENUE, CHICAGO 18, U. S. A.

District Offices in Principal Cities

PAPER, OIL AND ELECTROLYTIC MOTOR CAPACITORS

Speech Input Systems. "Elements of Speech Input Systems" designates an 18-page booklet (Form No. WECO-T2154) which describes in simple language the principal components and performance data of a typical modern speech input system for both a-m and f-m broadcasting. Information Dept., Western Electric Co., Inc., 195 Broadway, New York 17, N. Y.

Permanent Magnets. Permanent Magnets for Industry is the title of a 24-page, illustrated manual which gives the factors affecting design, fabrication and application of Alnico permanent magnets. The Arnold Engineering Co., 147 E. Ontario St., Chicago 11, Ill.

Screws. A catalog containing 112 pages is devoted to the manufacturing processes, illustrations, and description of the many types of screws being made by New England Screw Co., Keene, N. H. This catalog is designated as No. 45.

Counting Device. Form No. 50 illustrates and describes among other types of counters an automatic batch-counting unit. Production Instrument Co., 710 W. Jackson Blvd., Chicago 6, Ill.

Bendix Radio Literature. Four separate pieces of literature available from Bendix Radio, Baltimore 4, Md., include the following: Bulletin No. SE-117 on type MN-57A loop position transmitter which indicates the position of a manually-driven loop antenna on an autosyn azimuth indicator; Bulletin No. SE-118 on type MI-32 interphone and isolation amplifier which provides interphone communication between as many as five different crew stations, and independent receiver selection by each of the five crew members without cross feed; a 4-page bulletin on type RA-2D communication receiver, an eight-channel, superheterodyne, crystal-controlled unit operating between 2700 and 7000 kc; and finally, an 8-page bulletin on type MN-31 Series automatic radio compass for aircraft navigation.



MODEL 56 WEBSTER RECORD CHANGER

... as new as the Post-War Era

In related industries—names with integrity and reputation go hand in hand. Thus—in radio-phonograph combinations—Webster Record Changer, Model No. 56, will continue in distinguished company—just as its predecessors have in the past. New brilliance of performance has been achieved—new mechanical perfection that will prove most pleasing to dealers and consumers alike. Read the following advantages—then contact us for full details and engineering council.

- ✓ Dependable heavy duty Webster 4 Pole motor—cushion mounted for silent operation. No audible rumble or “wow.”
- ✓ Records drop quietly—velvet soft heavy-pile turntable covering.
- ✓ Installation done from top—quick, easy mounting.
- ✓ 14-inch square mounting base. Over-all depth—above and below mounting board—9 inches.
- ✓ Built for lasting performance. Practically no service calls are required.
- ✓ Perfectly crafted—highly styled—beautiful lines.
- ✓ Changes all standard records. Plays ten 12” or twelve 10” records in one loading.
- ✓ Fast change cycle—approximately 4 seconds.
- ✓ Simple, fool-proof operation. Can not be “jammed.”
- ✓ Automatic shut-off after last record has played.
- ✓ Feather light needle pressure.
- ✓ Longer life for records—no cracks—no chipped edges.

KEEP UP A GOOD HABIT—BUY VICTORY BONDS



**WRITE
FOR
INFORMATION**

WEBSTER



CHICAGO

5610 BLOOMINGDALE AVENUE
CHICAGO 39, ILLINOIS

31 YEARS OF CONTINUOUS SUCCESSFUL MANUFACTURE



DOWN TO EARTH!

SAFELY AND QUICKLY

We now have our feet on the ground, and may again pursue our normal peacetime function to immediately utilize all our available facilities. Perhaps, temporarily, we can manufacture all, or part of your product while you redesign and retool a new model.

At the same time we earnestly seek the opportunity to discuss with designers, engineers and manufacturers considering new metal products or wrestling with difficult problems of design, fabrication and assembly, our especial ability to perform all of these functions for you.

If your manufacturing plans hit a bottleneck somewhere along the line, it is probable that consultation with Oiljak may discover a solution that will be mutually profitable.

MACHINING • STAMPING • WELDING • PLATING • PAINTING • ASSEMBLING

The OILJAK MANUFACTURING Co., Inc.
Montclair, N. J.

The Job Complete—from blueprint to finished product

Belden CONNECT-A-CORD

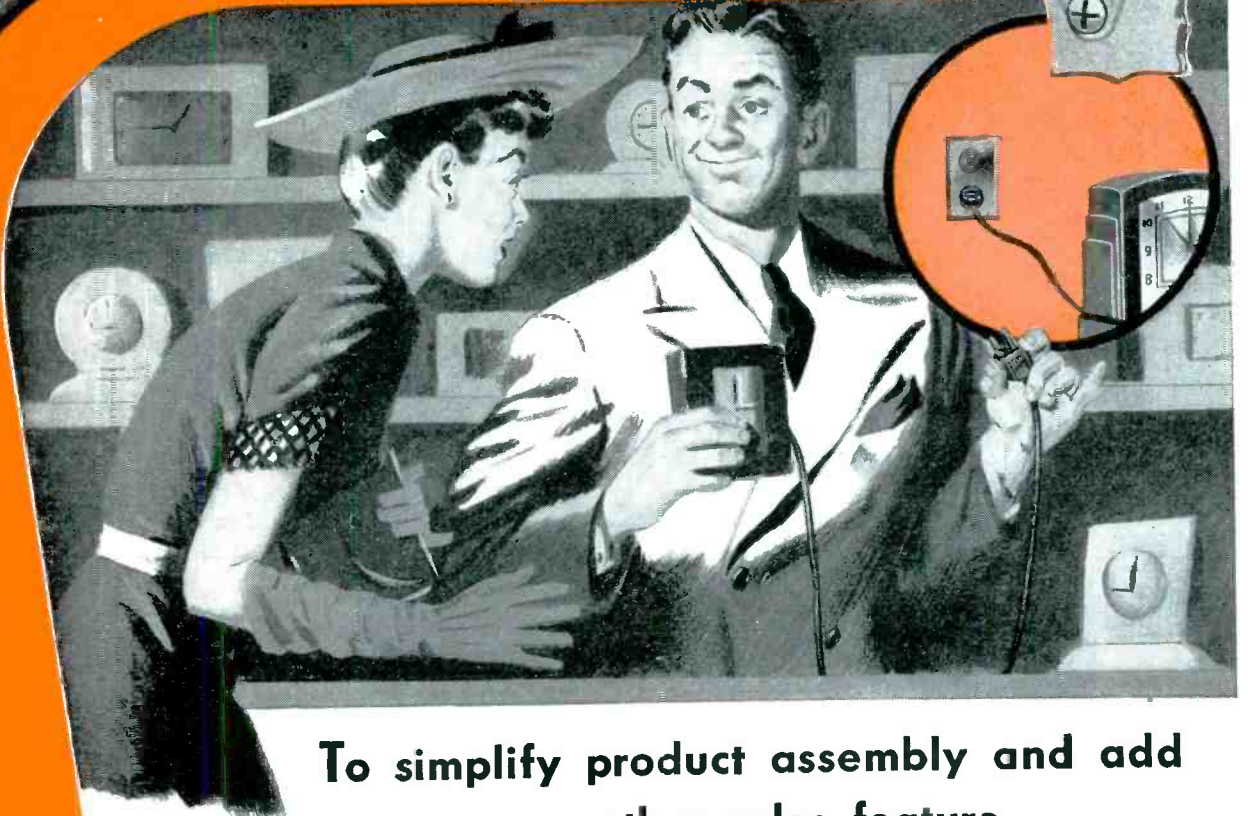

To simplify product assembly and add another sales feature . . .

THE INTERCHANGEABLE

Belden *CONNECT-A-CORD*

Detachable at both plug end and appliance end and easily interchangeable, Belden Connect-A-cordS simplify assembly, packing, and display—and add another effective sales feature to your newly designed electrical appliances. Available in various lengths (and in matching colors, too), they end the nuisances of too-short-to-reach cords and unsightly tangled coils of extra lengths. And consistent national advertising pre-sells your customers on these advantages.

Need for costly dealer cord repair services is eliminated with Connect-A-cordS, and, as with all other Belden electrical cords, complete freedom from corditis is assured. Write for complete information on the Connect-A-cord today. Belden Manufacturing Co., 4625 Van Buren St., Chicago 44, Ill.

The Belden CONNECT-A-CORD



CONNECTOR + CONDUCTOR + PLUG

A new advantage appliance users want

Though the Belden Connect-A-cord is a new idea, extensive surveys have already shown that electrical appliance users want its advantages. No mere postwar dream, it is already engineered—and it is offered now only after complete service tests and surveys to establish customer demand.

Belden

Corditis-free **CORDS**

KESTER FLUXES INSURE *Solder Performance*



Here's Why—

- ➔ Kester Fluxes are scientifically compounded to protect your product against solder failure! No matter what type of soldering—delicate dip-soldered electrical connections, sweating operations, or various types of seams—Kester makes the right and specific flux to prepare the way for tight, trouble-free solder bonds.
- ➔ For over 46 years, Kester has been the leading name in the field of solder. Kester fluxes of highest quality and unvarying uniformity, have been perfected through laboratory research and practical experience.
- ➔ For any solder problems you may have—consult Kester engineers. They'll gladly recommend the right flux to insure the lasting quality of your product . . . and at no obligation.

★ BUY VICTORY BONDS ★

KESTER SOLDER COMPANY

4204 WRIGHTWOOD AVE., CHICAGO 29, ILL.

Eastern Plant: Newark, N. J. Canadian Plant: Brantford, Ont.



KESTER

Solder Fluxes

STANDARD FOR INDUSTRY

Electronic Components. Catalog No. RC-6 contains 32 pages of data on fixed and variable resistors, iron cores, line and slide switches. Stackpole Carbon Co., St. Marys, Pa.

Electron Optics. Precision Optics by American Methods is the title of a booklet from American Lens Co., Inc., 45 Lispenard St., New York 13, N. Y. The booklet contains information for television set manufacturers (or manufacturers using electron optics) on optical components or complete optical systems.

X-Ray Diffraction. Two reprints from North American Philips Co., Inc., 100 East 42 St., New York 17, N. Y. include a 4-page folder from *Rubber Age* entitled, "Use of Low-Angle X-Ray Scattering in the Study of Catalysts, Viruses and Other Materials," and a 16-page booklet entitled, "X-Ray Diffraction—Basic Theory, Principles and Applications", reprinted from *Petroleum Refiner*.

Electrical Insulating Materials. The electrical and mechanical properties of various insulating materials is contained in a 4-page quick-reference folder available from Continental-Diamond Fibre Co., Newark 12, Delaware.

Aircraft Accessories. "Electro-Mechanical Aircraft Accessories" is the title of a bound data book (No. EM-200) containing approximately 225 pages. The book contains graphs, drawings and illustrations in black and white as well as three-dimensional color pictures of such equipment as linear and rotary actuators, power units, screw jacks, flexible shafting and accessories, motors and controls. Lear Inc., Piqua, Ohio.

Beryllium. A 4-page bulletin illustrates and describes Brush beryllium metal, alloys and compounds for use in x-ray transmission and sound velocity. The Brush Beryllium Co., 3714 Chester Ave., Cleveland 14, Ohio.

PIERCING 1/4" STEEL

... EASY WITH WHISTLER
HEAVY DUTY ADJUSTABLE
DIES



Manufacturing costs can be materially reduced and conversion speeded up by putting the "SX" series of heavy duty adjustable perforating dies to work in your plant.

Available from stock in standard sizes and shapes from 1/8" to 1 1/2". Continued reuse in different groupings spreads original costs over a multitude of jobs. Closer centers permit more perforations per press operation. Absolute accuracy on

short or long runs. Quick changeover of hole arrangements contributes to greater production from your presses.

If perforating, notching, slitting or rounding dies are used in the manufacture of your products and you are working with materials up to 1/4" steel, then good business dictates that you write for the Whistler catalogs and know the time and money saving advantages of Whistler Heavy Duty Adjustable Dies.

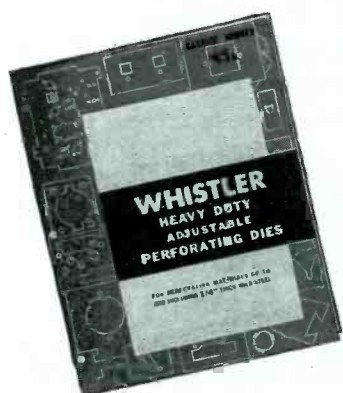

S. B. WHISTLER & SONS, INC.

752-756 MILITARY ROAD

BUFFALO 17, NEW YORK



MINIMUM FRICTION
LONG LIFE ♪ **SILENT**
CONSTANT SPEED

SEEBURG RECORD CHANGERS

The engineering features in SEEBURG RECORD CHANGERS are generally included in high priced professional transcription equipment.



SEEBURG *Wire* RECORDER

The SEEBURG WIRE RECORDER is an electronic engineering achievement! One simple control knob operates the SEEBURG WIRE RECORDER to reproduce and record speeches, plays, meetings, music, radio programs, etc. No needles or discs are used.

IT WILL BE NECESSARY...
 for radio manufacturers to make provisions
 in their circuits to accommodate the SEEBURG
 WIRE RECORDER. We therefore invite prompt
 inquiries from interested radio manufacturers.

Seeburg

J. P. SEEBURG CORPORATION · CHICAGO

**A
DISTINCT ADVANCE
IN
BRACKET
DESIGN**

BASE MOUNTING

INVERTED MOUNTING

CAPACITOR

U-BEND

CHASSIS

This removable mounting bracket is now available for most G-E rectangular a-c and d-c capacitors, permitting the capacitor to be mounted upright or inverted.

1. Provides "spring-washer" effect for secure capacitor mounting.
2. Reduces strain on capacitor and chassis.
3. Compensates for manufacturing tolerances in height of case.

In contrast with the conventional L-shaped bracket, this U-bend construction minimizes the stress on the metal chassis and prevents distortion when mounting bolts are tightened. The mounting foot is sufficiently flexible to compensate for normal tolerances in height of case, and for variations in dimensions of the bracket itself.

The brackets are sufficiently thick to provide strong, rigid support. A cor-

rosion-resistant finish of lacquered zinc plate assures a good ground from capacitor to chassis. The brackets have either one or two mounting holes depending upon the width of the capacitor.

These brackets are an exclusive feature on G-E capacitors. Spade-type and L-shaped brackets can still be obtained when desired. Ask for Bulletin GEA-4357 for information on the G-E capacitors that can now be furnished with this improved feature. *Apparatus Dept., General Electric Company, Schenectady 5, N. Y.*



CAPACITORS

Buy all the BONDS you can
—and keep all you buy

GENERAL  ELECTRIC

407-96-5700

INDUSTRIAL CONTROL

Capacitor-Discharge Roll Welder.....	232	Radio Control of Truck Traffic.....	248
Electronics in Postwar Automobile...	232	Pressure Sensing Unit.....	252
Rapid Infrared Analysis.....	232	Railway Communications on 2660 MC	256
C-R Tube Solves Production Problems.	234	Ship-search Radar for Troopships.....	260
Electronic Fuel Gaging.....	234	H-F Aircraft Ignition System.....	264
High-speed Components Tester.....	244	Bridge for Production Testing.....	272
Selsyn Indicating Systems.....		276	

Capacitor-Discharge Roll Welder

ELECTRONIC CONTROLS and rectifiers combine with a bank of as many as 84 120- μ f capacitors to operate a newly developed roll spot welder in one of the plants of Aluminum Corp. of America. Made by Federal, the unit provides speeds as high as 300 welds per minute on sheets of 0.032-in. aluminum, and

established in portions up to the total of the capacitor bank and then dumped into the welder transformer through the action of Westinghouse electronic controls, housed in the center cabinet in Fig. 2. Rectifier and voltage-regulating gear as well as part of the capacitor bank is in this same enclosure while

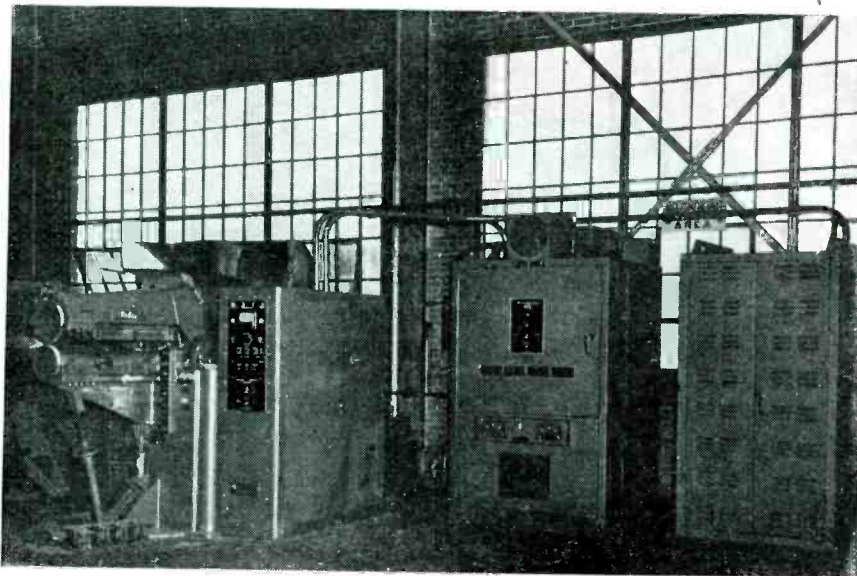

Fig. 2—Center cabinet of roll spot welder group contains main controls, rectifier, voltage regulating system, and some of the capacitors. Enclosure at right holds remainder of capacitor bank

can handle thicknesses up to 0.187 in.

According to the setting of controls, 1500- to 3000-volt charges are

the remainder of the capacitors are in the right-hand cabinet. Peak power demand is 100 kva on a three-phase system.

Electronics in the Postwar Automobile

A REDUCTION of some 99.9 percent in the time required for heat-treating starter ring gears has been achieved by Studebaker Corp. with the use of electronic induction heating.

Under the old procedure, the ring gear was taken from the machining department and heated in a gas

oven for an hour before quenching. A draw followed to temper the body of the ring, requiring another hour and a half.

Now, an electronic heater is located in the machining department in proper manufacturing sequence. Gear teeth are brought to a specified 1500 deg within 13 seconds and

water-quenched on the spot within 7 seconds.

The illustration shows the fixture in use. Surrounded by a two-layer, water-cooled coil, the gear is brought to temperature in a 540-ke field. At the conclusion of the heating cycle, the gear is rotated at 75 rpm while quench water is applied through the outer perforated tube.

In addition to the time saved by this process, there are other advantages. It is possible to harden the part with the same precision used in machining it. Only the



Flywheel ring gear for a Studebaker is set up in the hardening fixture recently added to the production line. With this equipment, a better gear is produced with a 99.9 percent reduction in heat-treating time

teeth are hardened. This aids in later assembly since the ring is expanded to fit with a permanent grip on the flywheel and all over hardening used to be a detriment in this operation. Tests show that the ring will withstand four times the number of starts expected in the normal life of an automobile and rejection from distortion and brittleness has been all but eliminated.

Infrared Spectroscopy for Rapid Analysis

THE ACCOMPANYING ILLUSTRATION shows a new infrared spectroscope and its developer, Dr. Donald K. Coles of Westinghouse Research Laboratories.

A sample of material—liquid, solid, or solution—is placed in the special holder in Dr. Coles' hand



AUDIPOINTS

Audiopoints, made by skilled craftsmen, are available in three types of recording styli and three types of playback points. Cutting and playback points are matched to give finest performance.

RECORDING POINTS

- SAPPHIRE NO. 14, for professionals, designed to give proper thread throw. No finer made.
- STELLITE NO. 34, professional type. Cuts quiet, shiny groove for several hours.
- DIAMOND-LAPPED STEEL NO. 50, cuts a fine, quiet groove, gives from 15 to 30 minutes actual recording time.

PLAYBACK POINTS

- SAPPHIRE NO. 113, finest obtainable. Complete fidelity and minimum disc wear.
- BENT SHANK NO. 154, for heavy pickups.
- STRAIGHT SHANK STEEL NO. 151, for light pickups.

Audio's resharping and repolishing services give real economy in the use of **AUDIPOINTS**, Nos. 14, 34 and 113. Consult your local dealer.

There Is An Audiodisc And An Audiopoint For Every Recording Need

AUDIODISCS have all of the features essential to high fidelity recording. A superior lacquer is applied by a unique process that gives a flawless surface. In cutting, the thread throws well and there is no static. In playback, whether at once or in the future, there is low surface noise. Their playback life is unequalled. There are six types of **AUDIODISCS**:

- RED LABEL** tops all accepted quality standards for professional use. Double-sided in 6½", 8", 10", 12" and 16" diameters.
- SINGLE FACE RED LABEL** brings new economy to applications requiring but one side. 12" and 16" diameters.
- YELLOW LABEL**, Double-sided blanks of uniform quality and "wide latitude." Extra-fine adjustments unnecessary. Sizes as Red Label.
- REFERENCE** permits extreme economy in test-cuts, filing and reference recordings. Double-sided in 10", 12" and 16" diameters.
- MASTERS** for choice copies (pressings) after electroplating. Double or single face in 12", 13¼" and 17¼" diameters.
- BLUE LABEL** best discs at low cost. Thin aluminum base, same recording lacquer as professional **AUDIODISCS**. 6½", 8" and 10".

All **AUDIODISCS** are manufactured on aluminum base—and glass base too, except for the 6½" and Blue Label type.

AUDIO DEVICES, INC., 444 MADISON AVE., N. Y. C.



they speak for themselves **audiodiscs**

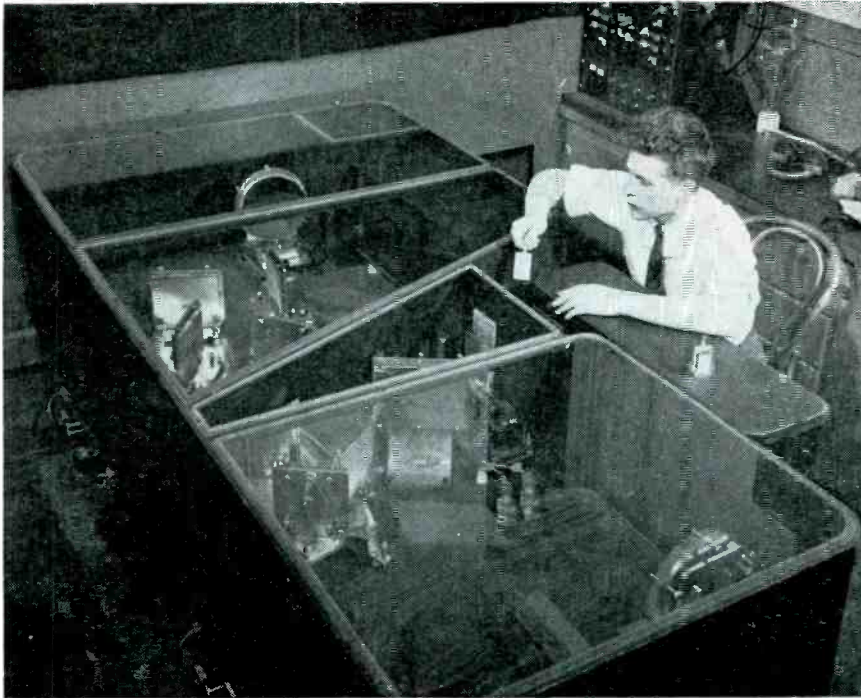

Electronic function serves the infrared spectroscope at Westinghouse Research Laboratories. Infrared light output is converted to electrical current, amplified, and recorded on a pen-writing chart

and inserted in the unit so a beam of infrared light, produced by a heated silicon-carbide rod, is directed through it. The invisible light is conducted along a 30-ft zig-zag path by the action of mirrors and prisms, which are visible in the illustration, and ends up at a sensitive receiver which converts the light into electrical current. From there it is amplified and recorded on a pen-writing chart outside the machine.

Dips and peaks in the chart reveal the identity of materials in the sample and tell how much of each is present. Depending upon ambient temperature, molecules of each element have their own resonant frequency. Material in the sample manifests itself by absorbing infrared light at its own particular frequency. The resulting chart interprets the attenuation of a frequency as the presence of its corresponding material.

Cathode-Ray Tube Solves Production Problems

INTRICATE MATHEMATICAL PROBLEMS which might require years of ordinary calculations are solved in a few days by the mechanical transient analyzer shown here being operated by Dr. Gilbert D. McCann, who together with Harry E.

Criner, developed the unit at Westinghouse Electric Corp.

Originally designed to meet new problems in the design of turbo-generator units, the analyzer has been pressed into service on such diverse calculations as those in-

volved in vibration studies on ship propulsion equipment and the mechanics of packing electron tubes against damage in shipment.

Electrical counterparts are assigned to all the mechanical factors involved in a problem, circuits are connected in appropriate sequence, and transient impulses are applied by rotating mechanical switches. The solutions are written on cathode-ray screens of conventional oscilloscopes.

"Engineers have long recognized a relationship between mechanical and electrical systems," says Dr. McCann, "but the development of apparatus to carry through these relations for a practical purpose has been a stumbling block to their full use." The particular development which made the new analyzer possible is a specially constructed low-loss inductance which permits the representation of mechanical systems with extremely low damping.

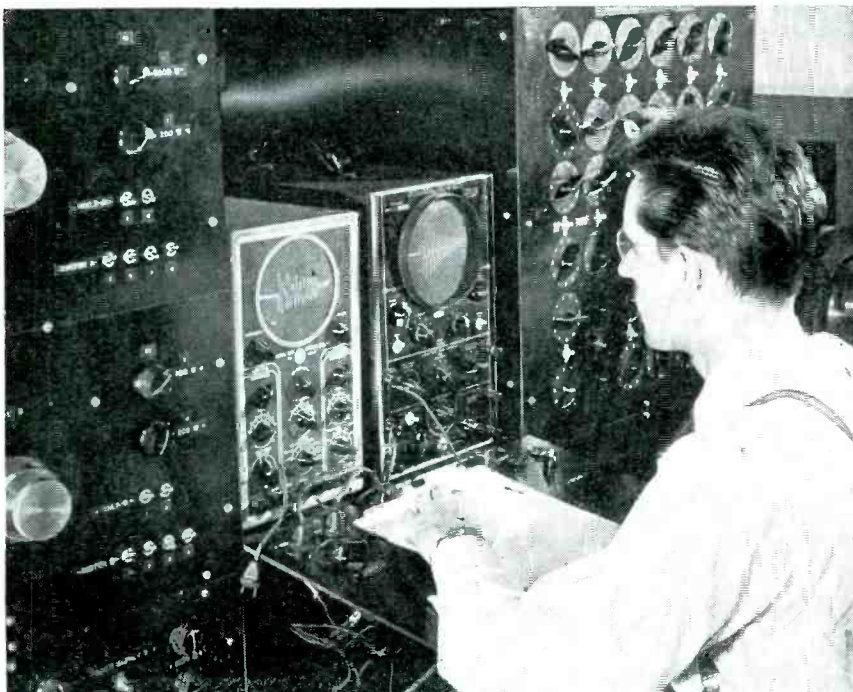

Cathode-ray oscilloscopes provide the answers to mathematical problems in new Westinghouse analyzer

Electronic Fuel Gaging

MINIMIZING ERROR and increasing reliability are two of the main achievements of a capacitor-type electronic fuel gage designed for

A HELPING HAND FOR...

VIBRATION DETECTION and ANALYSIS

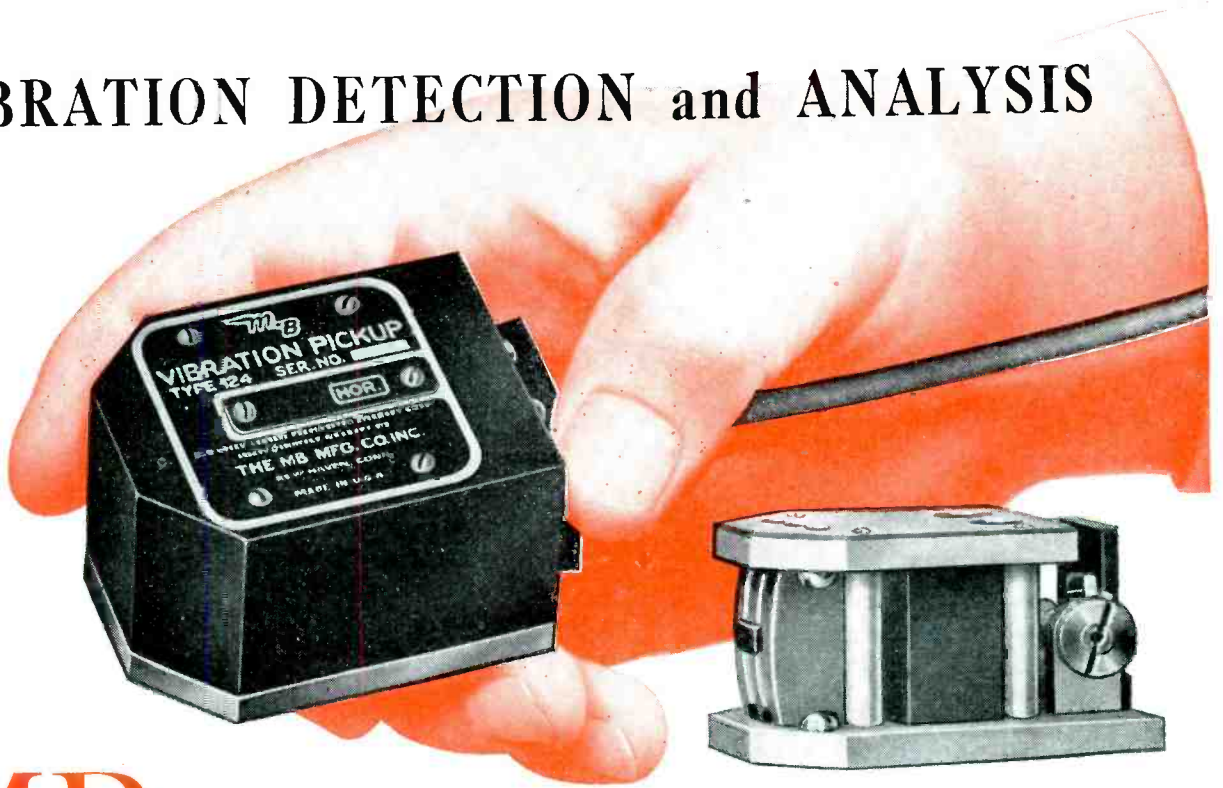

MB VIBRATION PICKUP

SENSITIVE TO LOW AMPLITUDE VIBRATIONS, and exceptionally durable under *severe* vibratory conditions, this MB Pickup can be used on a wide range of equipment . . . from small, high-speed rotary motors, to massive, high-powered engines.

It has a high output signal level. With standard equipment, accurate vibratory wave forms can be seen, studied, and recorded.

The MB Pickup is usually operated as a seismic instrument. A lightweight coil, free to move in a powerful magnetic field, generates a voltage proportional to vibratory velocity. Though the complete unit weighs only 8½ ounces, where this

weight would influence vibrations, provision can be made for attaching the very light coil directly to the tested structure.

Electrically damped, the MB Pickup maintains its calibration under wide temperature ranges. It can be used in horizontal or vertical planes without affecting the calibration. Adjustment is simple, quick.

Vibration reduction is an essential for product improvement—for extending service life. And the first step is accurate location and diagnosis. You'll find the MB Pickup a big help. Write for 4-page folder. It gives you complete details, specifications.

THE
MB
MANUFACTURING COMPANY, INC.
Vibration Division
1066 State Street, New Haven 11, Conn.



VIBRATION ISOLATOR UNITS AND MOUNTINGS • SPECIAL VIBRATION TEST EQUIPMENT



THE MB MANUFACTURING COMPANY, INC.
Vibration Division.
1066 STATE STREET, NEW HAVEN 11, CONN.

Please send descriptive folder on the Vibration Pickup.

Name..... Position.....

Company

Address

For Quick Visual Indication

Investigate the Unique Characteristics of G-E Neon Glow Lamps

THE unique characteristics of General Electric Neon Glow Lamps recommend them for a variety of uses in radios and electronic devices . . . as indicators, voltage regulators, pilot lights and test lamps.

The uses described at right are typical. If you think G-E Neon Glow Lamps can be useful to you, write or phone the address below. Experienced General Electric Lamp Engineers will be glad to discuss your problems with you.

CONSIDER THESE ADVANTAGES

1. Distinctive orange-red glow — no colored cover glass needed.
2. Dependable performance and long life — rated at 3,000 hours.
3. Very low current consumption — less than ½ milliamperere for smallest lamp.
4. Variety of sizes and wattages.
5. High resistance to vibration, shock.
6. Normally usable on a-c or d-c.
7. Screw base lamps for 105-125 v. circuits; similar lamps available with bayonet bases, but external resistance required.
8. Produce practically no heat.
9. Nearly flat volt-ampere characteristics.
10. Insensitive to voltage variations above critical value.

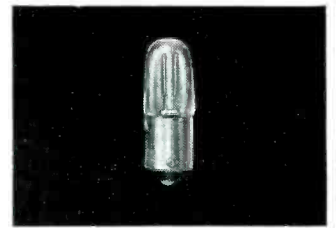

NE-51 For general indication, such as showing existence of potential across various parts of electrical circuits.



NE-17 Indicator and pilot light lamp that flashes to show condition of B-battery in portable radios. Frequency of flashes decreases as battery runs down.

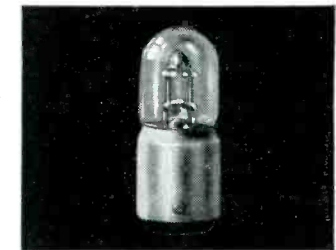

NE-48 (also N-E 16). Indicator lamps. Special volt-ampere characteristics of these lamps indicate use as voltage regulators. Screw base lamp available as NE-45.*

*NE-16 meets JAN-1A specifications for 991. Special marking JCG-991 supplied for small extra charge.

ORDER NO.	NE-2	NE-51	NE-17	NE-48	NE-16	NE-45	NE-30	NE-32	NE-34	NE-36	NE-40	NE-42
Watts, Nominal	½	½	③	¼	¼	¼	1	1	2	2	3	3
Volts (Circuit)	105-125	105-125	③	105-125	105-125	105-125	105-125	105-125	105-125	105-125	105-125	105-125
Starting Voltage ①	AC 85 DC 90	65 90	③	65 90	⑤	65 90	60 85	60 85	60 85	60 85	60 85	60 85
Base	★Unbased (Wire Terminals)	★S. C. Bay. Min.	★D. C. Bay. Cand.	★D. C. Bay. Cand.	★D. C. Bay. Cand.	Cand. Screw	Medium Screw	★D. C. Bay. Cand.	Medium Screw	★Sk. D. C. Bay. Cand.	Medium Screw	★Sk. D. C. Bay. Cand.
Maximum Overall Length	② 1¼"	1¼"	1½"	1½"	1½"	1¾"	2¼"	2"	3¾"	3¾"	3½"	3¾"
List Price (plus tax)	\$.08	\$.10	\$.45	\$.35	\$.42	\$.40	\$.40	\$.45	\$.50	\$.55	\$.60	\$.65

① Applies to lamp when new.

② Glass part; wire terminals extend additional 1¼".

③ Designed for DC flashing operation in RC circuit.

④ Meets JAN-1A specifications for 991. Special marking JCG-991 supplied at small extra charge.

⑤ Designed for 67-87 Volts D.C. (D.C. operating voltage at 1.5 milliamperes, 53-65 volts).

★ All Bayonet Base Lamps Need External Resistance.

For further information, write address below for Bulletin 7100

NELA SPECIALTY DIVISION, LAMP DEPARTMENT

GENERAL ELECTRIC

1 Newark Street, Hoboken, N. J.

ADAPTATION IS A PUSHOVER!

PROBLEM

To cool the portable projector to a maximum temperature rise of 35°F on the case surface, and to filter inlet air, eliminating dust from the air stream to keep multiple lenses clean. Current available: 20-23 V, D.C.

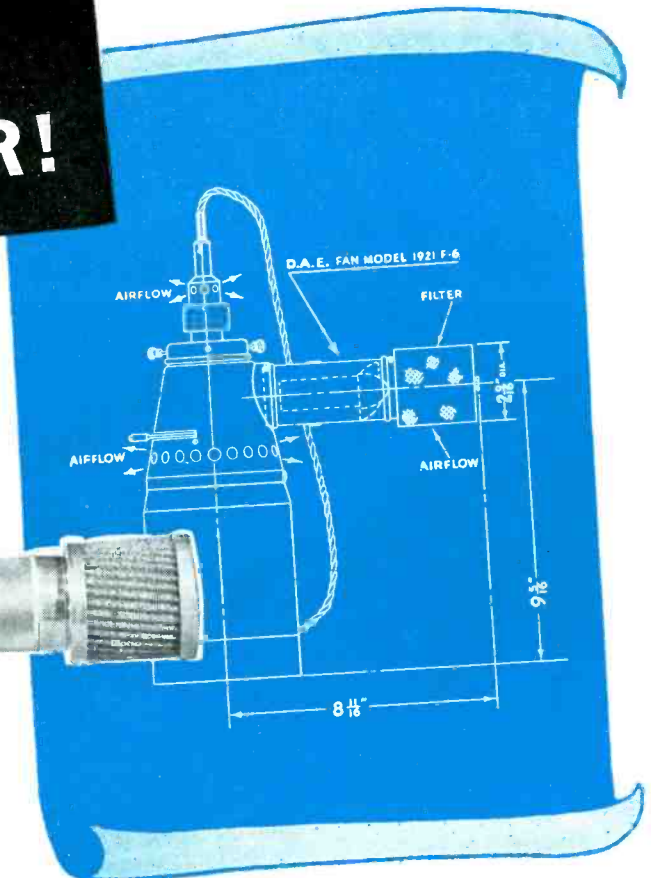
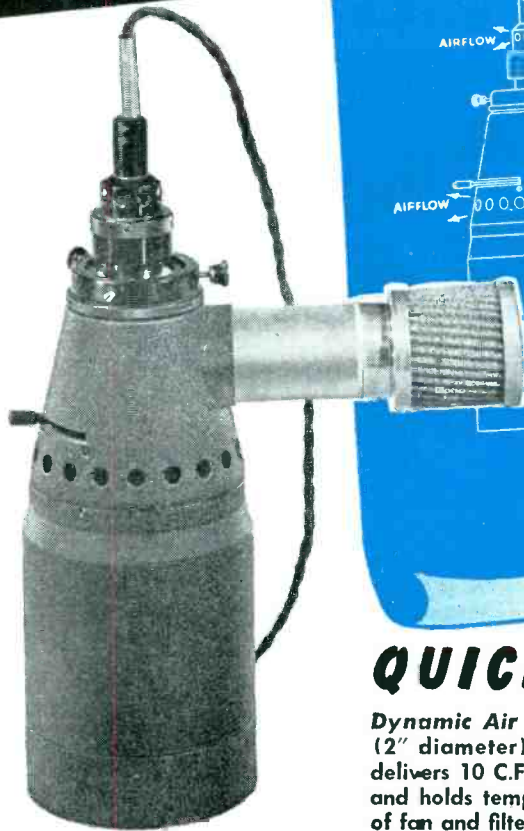
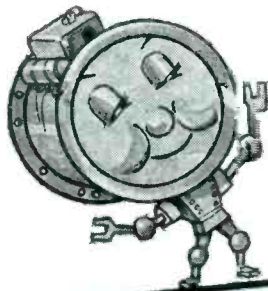

QUICKLY SOLVED

Dynamic Air Axial Flow Blower No. 1921F-6 (2" diameter), with an aluminum mesh filter, delivers 10 C.F.M., net, through the projector . . . and holds temperature rise to 15°F. Total weight of fan and filter, 10 oz.

DYNAMIC AIR AXIAL FLOW BLOWERS—ENGINEERED TO SAVE SPACE, WEIGHT AND HORSEPOWER — ARE BEING USED FOR:

- Electronic tube cooling
- Airplane heating
- Warm air furnaces
- Oil burners
- Stokers
- Refrigeration locker plants
- Quick freeze units
- Trains and buses
- . . . and for many other types of equipment requiring blowers.

GENERAL SPECIFICATIONS

24/28-V D.C.	1/500 to 4 h.p.
115-V D.C.	1/100 to 4 h.p.
115-V A.C.	1/100 to 1/2 h.p.
400-cycle A.C.	1/500 to 1 h.p.

Prototypes Available

Once the facts of the problem were known, adaptation of a Dynamic Air Axial Flow Blower and a Dynamic-designed heating unit to deliver the correct air flow at the required temperature rise was a "pushover" for Dynamic's experienced air engineers! This problem is typical of help they are giving in many fields—for both war and postwar needs.

Pioneered by 14 years' laboratory and field development work, Dynamic's Axial Flow Blowers are the most advanced application of the "air delivered in a straight line" principle . . . with a big saving in space, weight and horsepower input.

If you have an air movement problem in connection with present or projected equipment, take advantage of Dynamic's long experience in solving difficult blower problems . . . write or wire today!

DYNAMIC AIR ENGINEERING
LOS ANGELES, U. S. A.
DESIGNERS and BUILDERS of HIGH EFFICIENCY AXIAL FLOW EQUIPMENT *INC.*

PRECISION TEN TURN POTENTIOMETER

Linear

within

$\frac{1}{10}$ th of
1 per cent

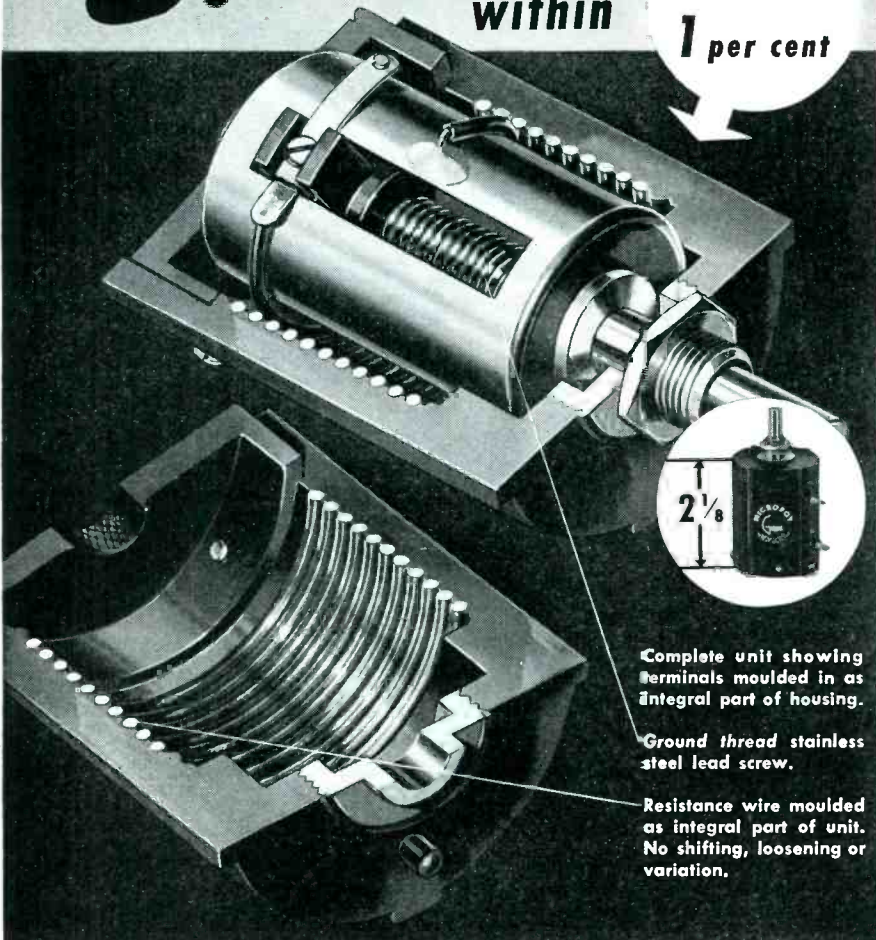

Complete unit showing terminals moulded in as integral part of housing.

Ground thread stainless steel lead screw.

Resistance wire moulded as integral part of unit. No shifting, loosening or variation.

Yes! linear to within $\frac{1}{10}$ th of 1% — the climax of long experience and accumulated "know-how" in precision engineering. This accuracy is *guaranteed* in the GIBBS MICROPOT, the new 10-turn Potentiometer.

In this remarkable unit resistance is directly proportional to shaft rotation through a full 3,600 degrees . . . within plus or minus 10 ohms in a 10,000 ohm unit. Such results are obtained by precision manufacturing and engineering knowledge.

Constant stability of resistance and linearity is assured through the fact that the resistance element, with both end terminals soldered in place, is moulded as an integral part of the instrument housing. There can be no loosening or shifting of the resistance wire. . . . Thousands of these

GIBBS MICROPOTS are proving their built-in long life qualities — many being used in radar operation.

In stock and available now are units of 1,000 to 30,000 ohm range. If required, special resistance values can be made to order. If you have a particular problem, our specialists will be glad to consult with you at any time. Write today for engineering specifications.

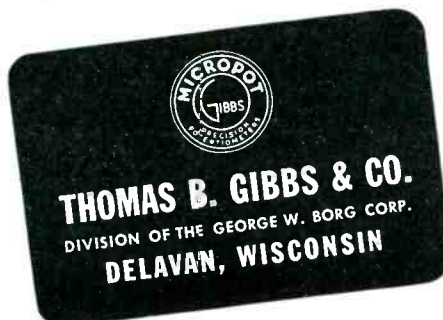

aircraft use and shown in the accompanying illustration. The components of the system include a capacitor sensing unit, a power unit, and a cockpit indicator.

As shown in the circuit diagram, the unit contains an oscillator section consisting of a single-tube oscillator that generates a frequency of approximately 10,000 cps.

The output frequency of this oscillator is impressed on two parallel circuits, each containing a capaci-

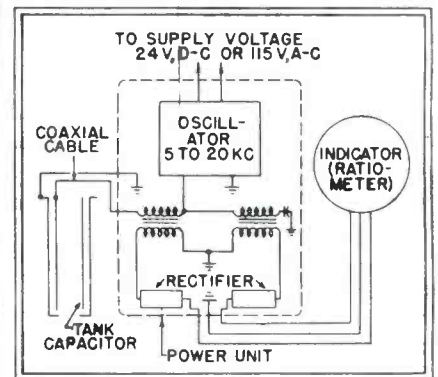

Circuit of gage that measures fuel to within three percent accuracy over all ranges of temperatures. Oscillator section consists of a single-tube generator

tor and an inductor. As shown, one of the capacitors is the tank unit whose capacitance varies as a function of the depth of fuel in the tank—its dielectric changes from 100 percent fuel to 100 percent air by intermediate stages as the fuel level is varied.

The other capacitor is fixed and serves as a reference for the variable capacitor. The cockpit gage takes the form of an indicating instrument reading the ratio between the rectified output of the fixed and variable circuits. The a-c voltage going to the rectifier on the variable side changes in ratio with the fuel level plus variations in the voltage and frequency from the oscillator. However, since the fixed side also exhibits the latter variations, the final ratio is independent of such irregularities.

The circuit designed by Simmonds Aerocessories, Inc., of New York, is such that accuracy of indication is maintained within one percent upon the replacement of any tube in the power unit. Failure of the tube will affect only one circuit,

VICTORY

OVER VIBRATION

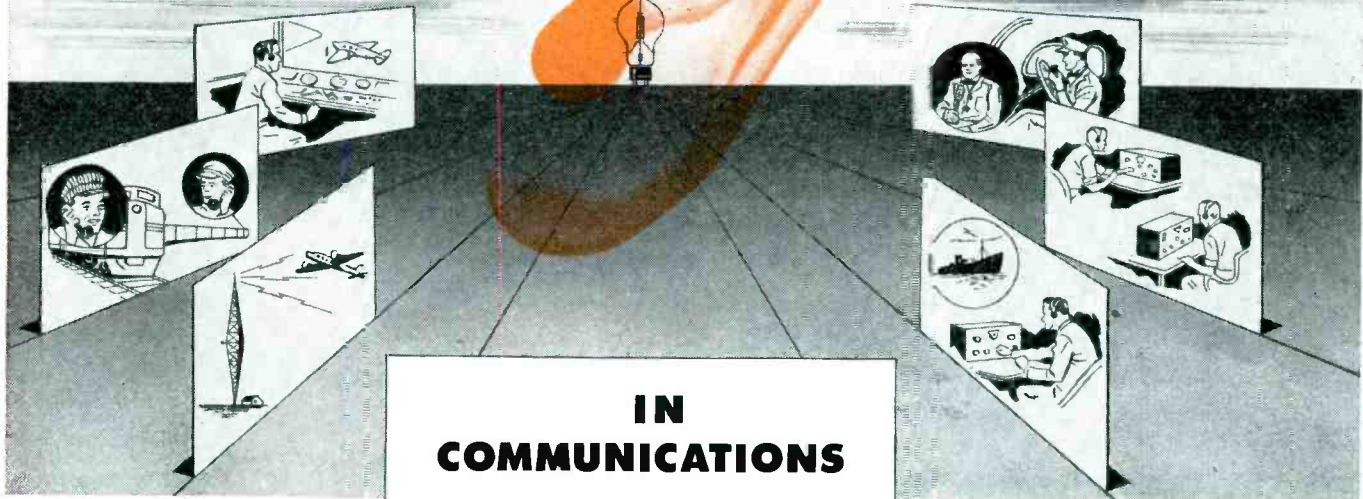

IN COMMUNICATIONS

AIR - LAND - SEA

Radio, electronic and radar equipment is necessarily delicate in construction and necessarily precise in its functioning. The enormous recent advances, first made on paper, when translated into practice have almost invariably run into one major difficulty . . . vibrational interference.

So, Lord, pioneer and leader in subduing the harmful forces of vibration, has been called upon for a wide range of applications in this field. Where possible, outside vibration forces have been isolated at their source; vibration of component parts has been controlled; and delicate parts and instruments have been protected from outside interference by isolation.

Lord engineers, the most experienced in the field of vibration, have access to the greatest file of experimental data and case studies of practical experience in existence, and they have the largest assortment of mountings, all of exclusive Shear Type Bonded Rubber and every one engineered for the specific conditions it has to meet.

The safety of passengers in the air, on land and sea; the pleasure of large audiences; the enjoyment of radio and television at home; all depend on the efficiency of communication systems, an efficiency which has been accomplished and continues to be promoted by constant consultation with Lord, HQVC (Headquarters for Vibration Control).

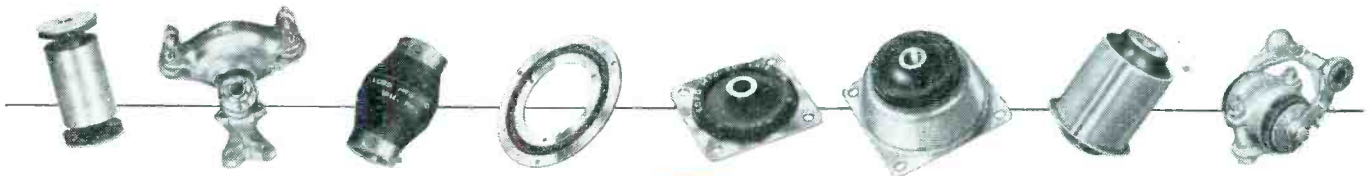

IT TAKES BONDED RUBBER *In Shear* TO ABSORB VIBRATION

LORD MANUFACTURING COMPANY
ERIE, PENNSYLVANIA

SALES REPRESENTATIVES
NEW YORK - 280 MADISON AVE.
CHICAGO - 520 N. MICHIGAN AVE.
DETROIT - 7310 WOODWARD AVE.
BURBANK, CAL. - 245 E. OLIVE AVE.
CANADIAN REPRESENTATIVE:
RAILWAY & POWER ENGINEERING CORP., LTD.
TORONTO, CANADA

Every genuine Lord Mounting carries the name "LORD" embossed in the rubber or in raised letters on the forgings.

Originators of Shear Type Bonded Rubber Mountings

It's here!

The new E·E TELEVISION RECTIFIER

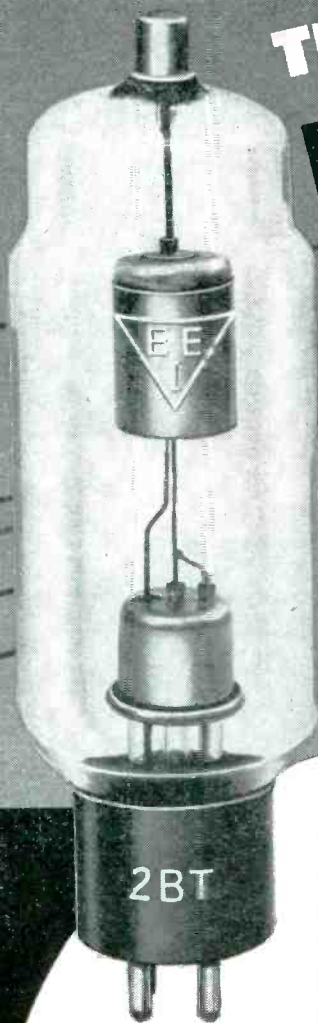

A HIGH VACUUM TUBE WITH
PEAK INVERSE VOLTAGE RAT-
ING OF 40KV. AVERAGE
ANODE CURRENT 5 M.A.

E·E TYPE 2BT available now!

EE 2BT closes the gap in rectifier types suitable for television applications. It is a high vacuum type having high peak inverse rating, and expressly designed for plate supply in video receivers requiring potentials to 12,700 volts on the projector tube.

By incorporating the EE 2BT in television designs, engineers can now eliminate flashback trouble without specifying a rectifier with ratings considerably in excess of actual requirements. For complete specifications and for other important details that explain why the EE 2BT offers exceptional advantages to designers write today.

FAST DELIVERY!

The popular types (illustrated at left) are now supplied from stock. Write for data book, a thirty page compilation of electronic tube types, characteristics and operational information will be promptly furnished on request.

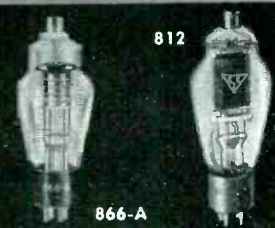
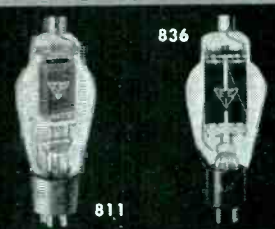
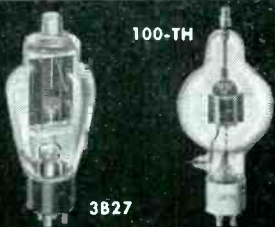

ELECTRONIC ENTERPRISES, INC.



GENERAL OFFICES: 65-67 SEVENTH AVENUE, NEWARK, 4, N. J.
EXPORT DIVISION: 25 WARREN STREET, NEW YORK, 7, NEW YORK
CABLE ADDRESS: SIMONTRICE NEWYORK

MITCHELL-RAND offers...

6 different brands of Varnished Tubing ... TO COVER EVERY KNOWN REQUIREMENT

- Standard
- Double Saturated
- Triple Strength
- Impregnated
- Hygrade
- Mirac

FIBREGLAS (INORGANIC) VARNISHED TUBINGS
 M-R Fibreglas Varnished Tubings are made in four grades; Standard; Double Saturated; Triple Strength and Impregnated.

STANDARD GRADE has maximum flexibility, is treated with a minimum of varnish and recommended for high temperatures where dielectric strength is not a factor.

DOUBLE SATURATED has all qualities of the Standard Grade but with additional coats of varnish to bring the dielectric rating up to 1500 volts.

TRIPLE STRENGTH is built up with coats of especially flexible insulation varnish for dielectric ratings up to 3,000 volts and is particularly suited where assembly operations include the possibility of rough handling.

IMPREGNATED is the Optimum in Superiority for high gloss, non-hydroscopic, resistance to high temperatures, oils, acids, etc. **IMPREGNATED** has a dielectric rating beyond 8,600 volts and is unequalled for Long Life Under Most Severe Conditions. Write For Samples.

FOR USERS OF COTTON YARN VARNISHED TUBINGS

The Mitchell-Rand **MIRAC** and **HYGRADE** Varnished Tubings of long staple fibre yarn are comparable to Fibreglas Tubings in dielectric ratings, tensile strength, flexibility and long life. Write For Samples.

FREE FOR THE ASKING →

Write today for your free copy of the M-R **WALL CHART** with its engineering tables, electrical symbols, carrying capacities of conductors, dielectric averages, thicknesses of insulating materials, tubing sizes, tap drill sizes, etc.



MITCHELL-RAND
 for 56 YEARS
 THE ELECTRICAL
 INSULATION
 HEADQUARTERS
 EST. 1889

MITCHELL-RAND INSULATION COMPANY, INC.
 51 MURRAY STREET Cortlandt 7-9264 NEW YORK 7, N.Y.

- A PARTIAL LIST OF M-R PRODUCTS**
- Fibreglas Saturated Sleeving, Varnished Tubing
 - Asbestos Sleeving and Tape
 - Varnished Cambric Cloth and Tape
 - Mica Plate, Tape, Paper, Cloth, Tubing
 - Fibreglas Braided Sleeving
 - Cotton Tapes, Webbing and Sleeving
 - Impregnated Varnish Tubing
 - Insulating Varnishes of all types
 - Extruded Plastic Tubing

POSSIBILITIES IN

PLASTICS

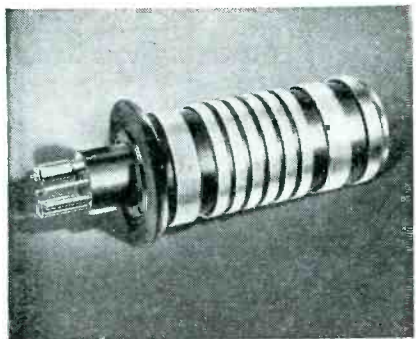
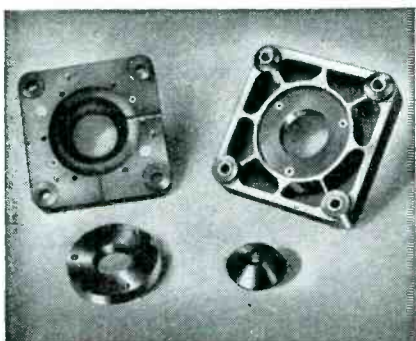

Above are examples of engineered plastics, produced by us for military requirements. Their design and production involved molding techniques that can be applied advantageously to many consumer products.

Familiar uses of plastics are being served again. Most significant, in suggesting the larger potential usefulness of molded plastics, will be their successful utilization in applications where other materials have been used by custom or tradition.

During the war years, plastics had to justify selection thru superior performance under field conditions. Molding experience and techniques developed and improved during that period are now available to you thru this organization.

If you seek product betterment, let us help you examine the possibilities in plastics. We have the most improved equipment for injection, transfer and compression molding. Our production is varied, from simple molded parts, produced in volume on high speed injection presses, to complex assemblies, transfer-molded with metal inserts. Our experience and complete facilities—from design to assembly—may benefit you. Get in touch with us. For information on our services, ask for Folder File E-12.



PLASTIC MANUFACTURERS

INCORPORATED

STAMFORD, CONNECTICUT

Representatives: DETROIT 2—805-06 New Center Bldg. • LOS ANGELES 35—1440 So. Robertson Blvd.
CANADA—A. & M. Accessories Ltd., 19 Melinda Street, Toronto; 1405 Bishop Street, Montreal

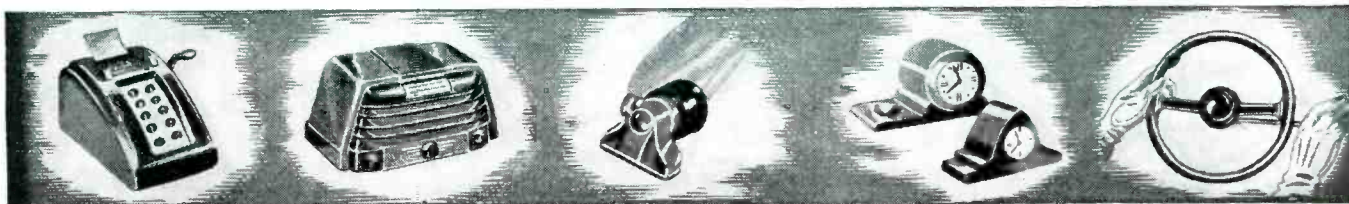

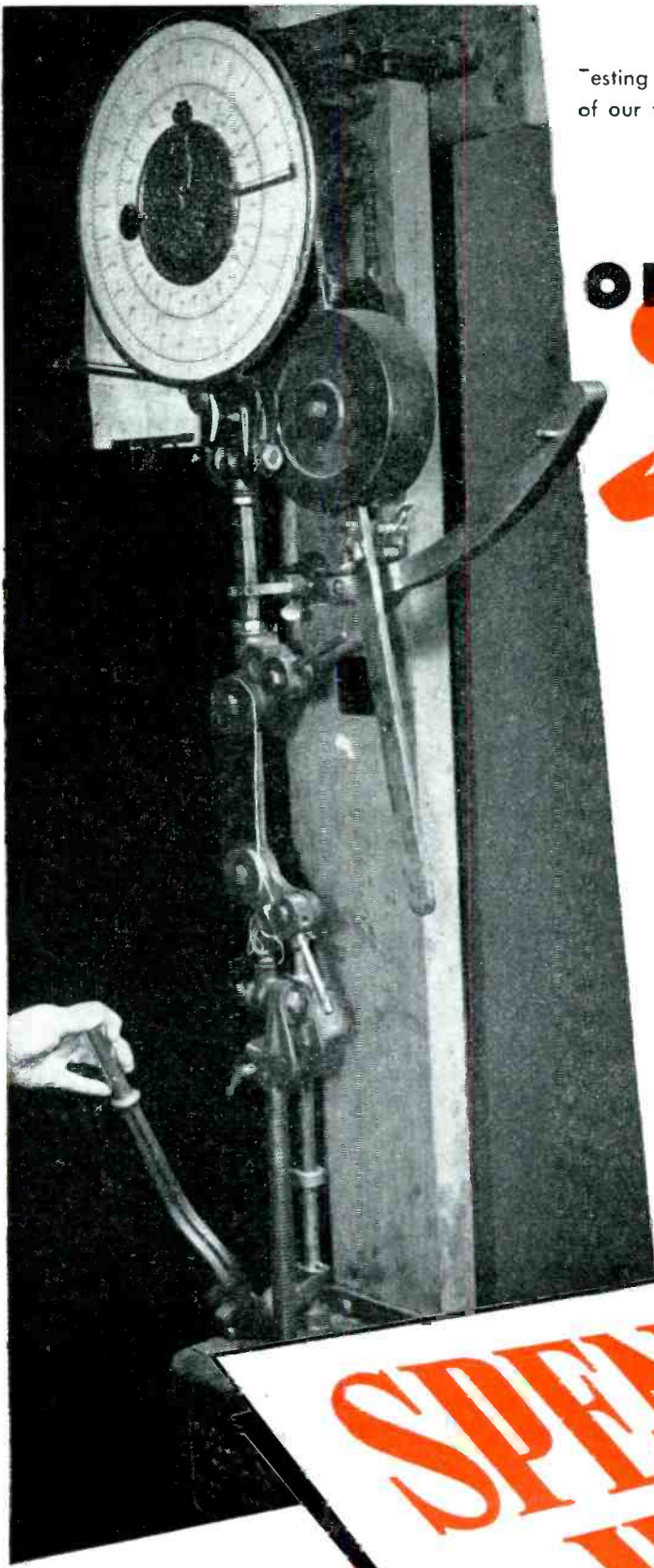

Testing tensile strength in one of our fine wire finishing rooms.

ONLY ONE . . .
Spencer!

Yes, only one of the many tests Spencer Wire is subjected to before the best fine wire is incorporated in your product. The coating, the physical characteristics and the chemical composition of each run of wire is controlled in our laboratories and wire drawing rooms. Beryllium-Copper, Phosphor Bronze, Stainless Steel, and High Carbon Steel Wire, in exacting sizes are made to your specifications. Consult our Engineering Department for the solution to your fine wire problems.

"SPECIFY SPENCER"
for exact specifications

**SPENCER
WIRE**

★ SPENCER WIRE COMPANY

WEST BROOKFIELD PLANT
WEST BROOKFIELD - MASS.

PROVEN IN WAR!

PROMPT DELIVERY!



Now Available

for Peace Time Application

TELEVISO Series 200A VT Voltmeter

TELEVISO pioneering in the production of measuring apparatus for the SONIC to UHT SPECTRUM, has specialized in building dependable Vacuum Tube Voltmeters.

A necessity wherever dependable voltage measurements within the range of 7 cps to 500 megacycles are required—the Televiso Series 200A VT Voltmeter is highly accurate and stable. **IMPORTANT WAR TIME DEVELOPMENTS ARE AVAILABLE FOR THE FIRST TIME IN THE FOLLOWING FEATURES:—**

SUPERSENSITIVE RANGE—the lowest readable voltage is .05 volts on a maximum scale range of .5 volt.

FIVE VOLTAGE RANGES—5, 2, 15, 50, 150—spread full scale on a 4½" meter dial for easy reading. Accuracy of readings are 2% full scale; middle scale accuracy is 5% or better.

PROBE CONSTRUCTION—detachable probe to eliminate cable wear; easily dismantled for tube replacement or for soldering to tube terminals for measurements in the 250-500 MC region; flat ½" wide brass terminals connect to input to make easy soldering to test or work piece; for low frequency work up to 100 MC, removable banana plugs are spaced ¼" center to center for use with standard jacks.

MECHANICAL CONSTRUCTION—of aluminum throughout; panel and cabinet are ¼" thick (cabinet is dural); sub-chassis is ¼" and spaced off the panel by studs to simplify servicing; all components are fastened to sub-chassis.

ELECTRICAL CONSTRUCTION AND CIRCUIT—Series 200A utilizes the finest components throughout and carries a two year guarantee. The circuit is a stable plate circuit rectifier. No diode input tube is used. The plate circuit rectifier type makes available higher input impedance at all frequencies. No shortening of input probe is required for zero adjustments. All zero adjustments are made once and remain constant. A panel adjuster is available to make the unit usable without heating up time. All filament and plate voltages are transformer and tube regulated.

BUILT-IN CALIBRATION VOLTAGE—All units have a jack which produces a constant 6.3 volts for standardizing. This is the regulated filament voltage. The sensitivity can be adjusted without tools in the event tubes are replaced in the field. The Series 200A will operate satisfactorily from any source of voltage from 95 to 130 volts ac. Line voltage surges are not observable during use.

SIZE—14"H x 9½"W x 7½"D. Guaranteed 2 years. Price \$170.00 F.O.B. Chicago.

TELEVISO PRODUCTS CO.

7466 IRVING PARK ROAD

CHICAGO 34, ILLINOIS

thus only one indicator reading. Failure of the tube causes the indicator to read off scale.

Four types of sensing units for tank mounting are provided. They include a flange type as shown in the illustration, a non-flange type which mounts by bolts to the inner walls of fuel tanks, a quick-assembly type held in self sealing tanks by cemented synthetic end-fittings, and

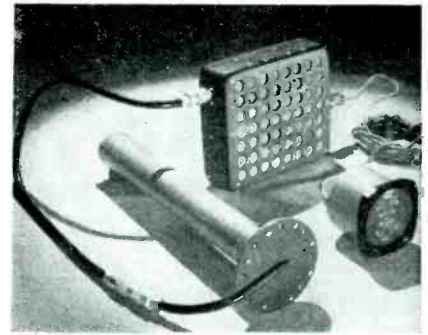

Capacitor-type electronic fuel gage is composed of tank unit, power unit, and cockpit indicator. Coaxial cable is used between tank and electronic section in power unit. No. 22 wire to indicator

a stiffener type which serves as a structural member of the tank in addition to its sensing element functions.

Power units are supplied for use with d-c or a-c power supply—d-c units approximating 1½ lb per indicator and a-c units running a little more.

Indicator

Cockpit gages are available in single and dual 100-deg arc types and small and large 250-deg units. Absolute adjustment for full and empty are made directly on the indicator, permitting calibration by a single individual. It is recommended that indicating gages be calibrated in weight of fuel rather than liquid measure, since this is more accurate. Junction transformer heads are used for multiple-tank unit installations as a means of hooking up inner and outer tube connections so that capacitances can be added.

High-speed Components Tester

SUITABLE FOR THE high-speed testing of capacitors and inductors, the circuit of an electronic limit bridge shown below utilizes a pair of 6E5

MEASURE YOUR HIGH VACUUMS WITH THIS REVOLUTIONARY NEW . . .

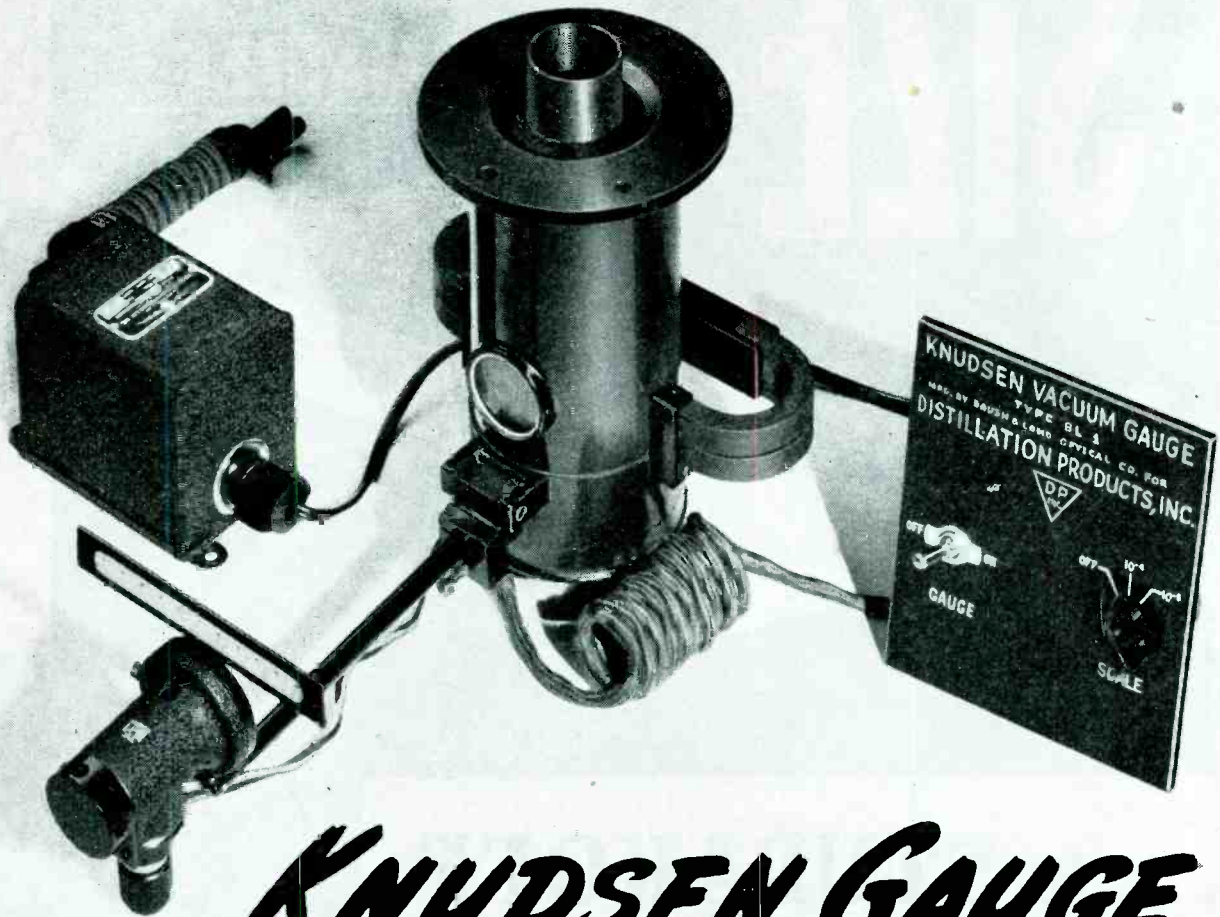

KNUDSEN GAUGE

HERE ARE THE NEW, PRACTICAL FEATURES:

- 1** No special mountings or rigid supports required . . . easy to transport . . . easy to install.
- 2** Direct continuous readings save time and labor. Its operation does not require a skilled technician.
- 3** Low temperature heaters . . . nothing to burn out . . . nothing can be damaged by atmospheric exposure.

THIS fine instrument is recommended for *every* vacuum installation where pressures of less than one micron are maintained. For full details on the Knudsen Gauge, high-vacuum equipment, installation or service, write—
High Vacuum Headquarters

VACUUM EQUIPMENT DIVISION
DISTILLATION PRODUCTS, INC.

ROCHESTER 13, N. Y.

SIZE DOESN'T MATTER

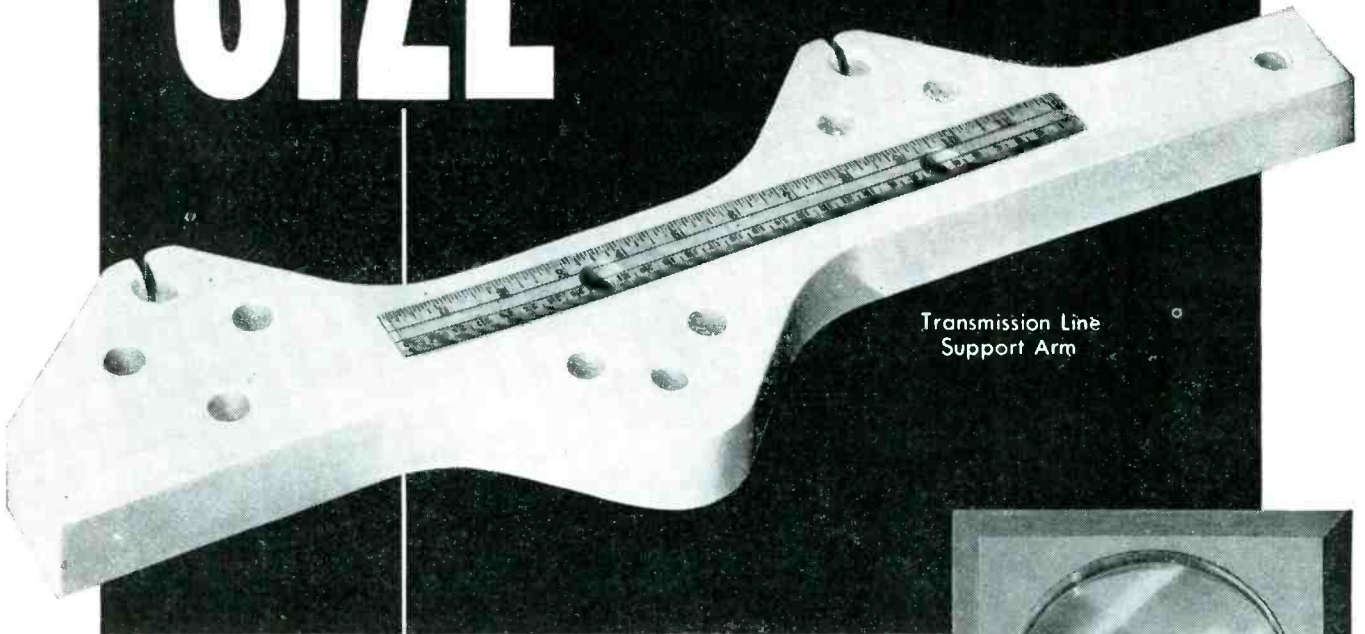

Transmission Line Support Arm

... to STUPAKOFF

LARGE or small, simple or complicated, if the need is for the proper ceramic insulators the place to get them is Stupakoff. Two generations of experience, engineering knowledge, continuous laboratory research, and that intangible but most valuable asset—ingenuity, are concentrated on the solution of every insulation problem which comes to Stupakoff. Precision in the final product is assured through absolute control over every procedure from selection of raw materials to final packing.

Quality comes first with Stupakoff, but is closely followed by efficiency which is extended to every known economy obtainable

through the use of up-to-date equipment, specialized trained workers, and modern volume production methods.

Stupakoff takes pride in its ability to produce the finest, most intricate precision ceramics obtainable. The toughest ceramic problem you can pose is a challenge to Stupakoff engineers, and they never refuse a challenge.

Consultation entails no obligation. Write, wire or phone us.

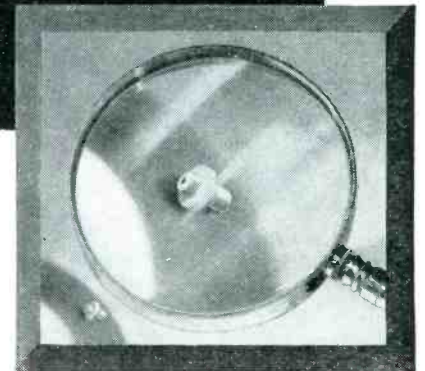

Radio Tube Cathode-Heater Insulator

★ BUY VICTORY BONDS ★



STUPAKOFF CERAMIC AND MANUFACTURING CO., LATROBE, PA.

Products for the World of Electronics



EXPORT DEPARTMENT — 13 EAST 40th ST., NEW YORK, N. Y. — Cable Address ARLAB — All Codes

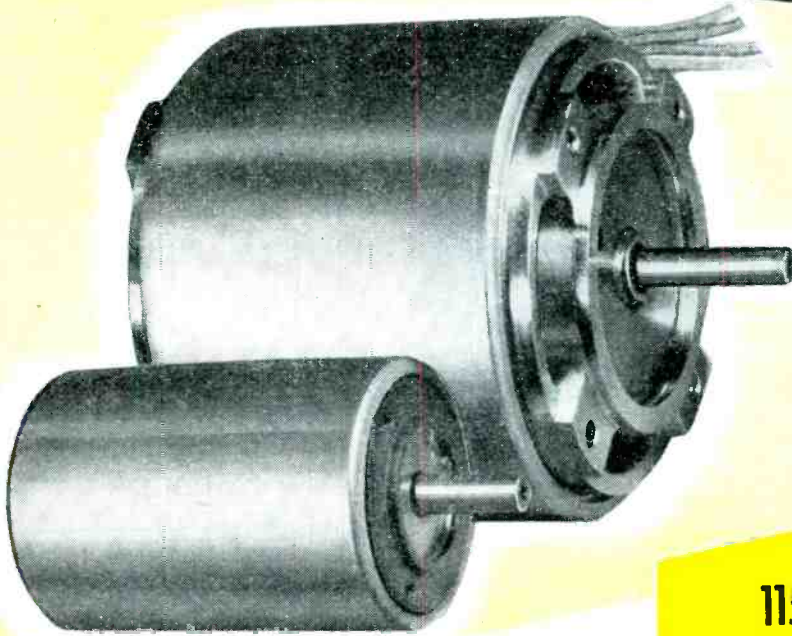

**NOW
READY**
for prompt delivery

**115 Volts — 60 Cycles
Fractional H. P. MOTORS**

**Capacitor
Shaded Pole
Synchronous**

with all the wartime improve-
ments in engineering and
workmanship.

ORDERS ARE INVITED

Deliveries ranging
from one to four
months.

FULL DATA ON REQUEST



EASTERN AIR DEVICES, INC.

585 Dean Street • Brooklyn 17, N. Y.

An Affiliate of The Fred Goetz Co., Inc., Est. 1893

MANUFACTURERS OF CONTROL DEVICES AND COMPONENTS FOR ELECTRICAL, ELECTRONIC AND MECHANICAL APPLICATIONS

CLASSIFICATION	H. P.	SPEED	DUTY	BEARINGS	MODEL No.
CAPACITOR INDUCTION MOTORS 3-5/16" Diam. Frame					
Capac. Start & Run	1/15	3000	Int.	Sealed Ball bearings	K70F K71F
" " "	1/30	3200	Cont.	"	K70B K71B
" " "	1/60	3300	"	"	K70 K71
" " "	1/15	3000	Int.	Sleeve	K73F
" " "	1/30	3200	Cont.	"	K73B
" " "	1/60	3300	"	"	K73
SHADED POLE MOTORS 3-5/16" Diam. Frame					
Shaded Pole	1/50	1420	Int.	Sealed Ball Bearings	KP70F KP71F
" " "	1/100	1530	Cont.	"	KP71 KP70
" " "	1/50	1420	Int.	Sleeve	KP73F
" " "	1/100	1530	Cont.	"	KP73
SYNCHRONOUS MOTORS 3-5/16" Diam. Frame					
Capac. Start & Run	1/100	1800	Cont.	Sealed Ball Bearings	JS70 JS71
" " "	1/100	3600	"	"	KS70 KS71
" " "	1/100	3600	"	Sleeve	KS73
CAPACITOR INDUCTION MOTORS 1 3/4" Diam. Frame					
Capac. Start & Run	1/100	3000	Int.	Ball Bearing	K49F
" " "	1/250	3150	Cont.	" "	K49
" " "	1/100	3000	Int.	Sleeve Bearing	K43F
" " "	1/300	3150	Cont.	"	K43

DELIVERIES RANGING FROM ONE TO FOUR MONTHS

Shaded Pole and Synchronous Motors in the 1 3/4" Frame Size Will Be Available Shortly

NEW!

A complete,
24 page
Illustrated
Manual

on *Permanent Magnets*

**PERMANENT
MAGNETS**
for Industry

THE ARNOLD ENGINEERING COMPANY
147 EAST ONTARIO STREET, CHICAGO 11, ILLINOIS

**WRITE TODAY,
on your letterhead,
for your free copy.**

This unusual Arnold manual on permanent magnets is the product of many months of careful research and planning.

It is devoted entirely to the consideration of the factors affecting the design, fabrication and application of Alnico permanent magnets. Written entirely by Arnold engineers, its purpose is to help engineers in industry to better utilize the magnetic and physical characteristics of the Alnico alloys in arriving at efficient design.

Write today, on your letterhead, for your free copy.

THE ARNOLD ENGINEERING COMPANY

147 EAST ONTARIO STREET, CHICAGO 11, ILLINOIS

Specialists in the Manufacture of ALNICO PERMANENT MAGNETS

cathode-ray indicator tubes for high and low indication. This saves the time which might be lost waiting for a meter needle to come to rest.

Involving the circuit of a modified Wheatstone bridge as shown, the instrument can be used to

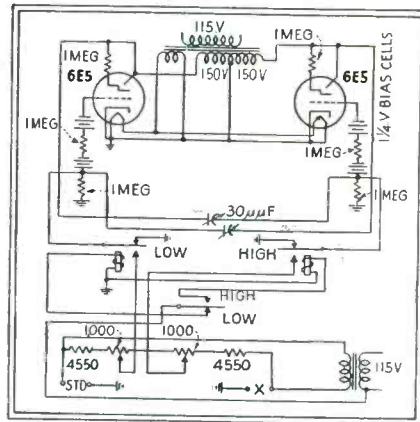

Circuit arrangement of capacitance and inductance limit bridge for high-speed production testing

measure impedances at 60 cps from 600 ohms to 2.6 meg which allows coverage of 0.001 to 4 μ f in capacitors and 2 to 7000 henrys in inductors. Limit dials are continuously variable from 0 to 30 percent low and from 0 to 40 percent high, and accuracy is within ± 1 percent of the standard.

Provision is made by Industrial Instruments, Inc. for attachment of special external test fixtures by which production testing speeds on capacitors, for instance, can be brought up to 1000 per hour. An inbuilt test switch and arrangements for connection of a breakdown or insulation-resistance tester and a shorting contact to discharge capacitors at the end of testing are incorporated in one such fixture.

• • •

Highway Radio Control of Truck Traffic

SUCCESSFUL TESTS have been concluded by Galvin Mfg. Corp. and Standard Freight Lines using standard f-m on 30 to 40 mc to investigate the possibilities of radio for traffic control, dispatching, and routing of trucks.

These tests showed that two-way communication between trucks and fixed stations can be maintained

*BLOW, BUGLES OF BATTLE, YOUR MARCHES OF PEACE;
EAST, WEST, NORTH AND SOUTH, LET THE LONG QUARREL CEASE.*

SING THE SONG OF GREAT JOY THAT THE ANGELS BEGAN,

SONG OF GLORY TO GOD, AND GOOD WILL TO MAN..

WHITTELY

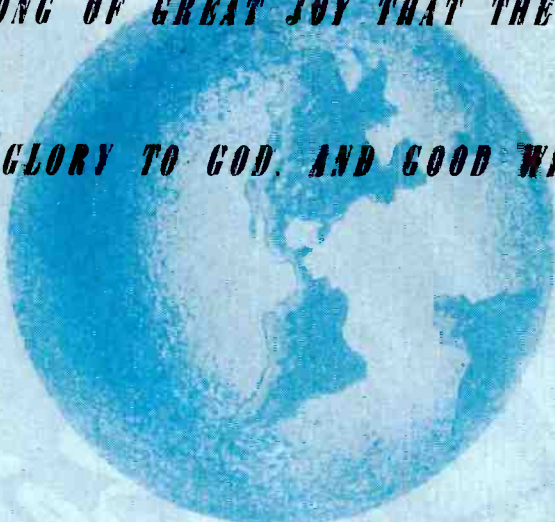

As the tumult and the shouting die . . . and the Yuletide bells ring out their old,
old story of peace on earth . . . it is good to make merry and wish our fellowmen
all over the world . . . Merry Christmas and a Grand New Year . . .

GENERAL INSTRUMENT CORPORATION

829 NEWARK AVENUE - ELIZABETH 3, N. J.

VARIABLE CONDENSERS · TUNING MECHANISMS · RECORD HANGERS · SPEAKERS · OTHER RADIO COMPONENTS

KEN-RAD

CATHODE-RAY TUBES



*Better
than ever*

➤ Whether for television, for oscilloscopes, or other uses, Ken-Rad Cathode-Ray Tubes are unsurpassed in clearness of image and other qualities born of advanced design ... Now important new Ken-Rad facilities promise still better, more reliable performance, further aiding manufacturers who feature these fine tubes in their equipment.

✂
● Write for your copy of
"Essential Characteristics"
the most complete digest of
tube information available.

178-D12-9850

KEN-RAD

DIVISION OF GENERAL ELECTRIC COMPANY
OWENSBORO, KENTUCKY

AGALLOY



Tubing

You may be sure of
proper surface condition
INSIDE and **OUTSIDE**
when you specify
AGALLOY

Small accurately drawn
tubing in

- MONEL metal
- INCONEL
- NICKEL
- 18-8 STAINLESS

Sizes up to and including $\frac{5}{8}$ -inch out-
side diameter.

Write for literature describing Agalloy's
complete line of cold drawn Stainless,
Carbon and Alloy tubing.



AGALLOY TUBING COMPANY • MILL: SPRINGFIELD, OHIO

EXECUTIVE AND SALES OFFICES: 1027 NEWARK AVE., ELIZABETH 3, N. J. • CHICAGO OFFICE: 221 NORTH LA SALLE ST., CHICAGO 1, ILLINOIS

IDEAL FOR RADIO WORK; KWIKHEAT SOLDERING IRON

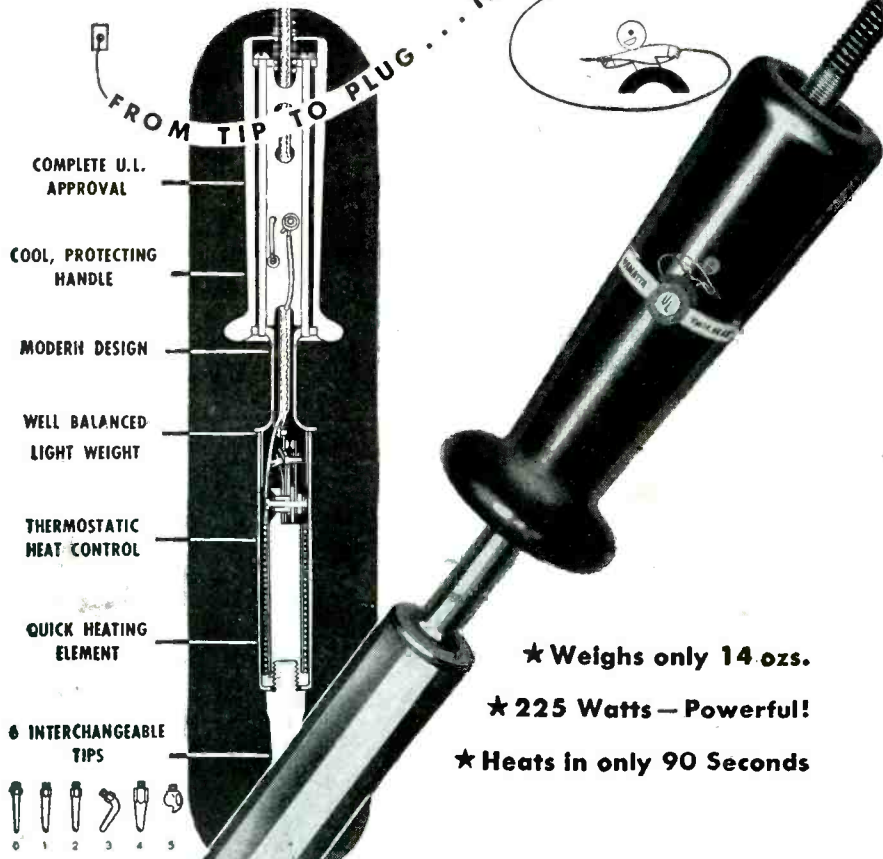

- ★ Weighs only 14 ozs.
- ★ 225 Watts — Powerful!
- ★ Heats in only 90 Seconds

Only the Kwikheat has... **Built-in Thermostatic Heat Control**

... Check the exclusive advantages that put the Kwikheat Soldering Iron in a class by itself... it's *HOT*, ready to use only 90 seconds after plugging in. Saves time. The built-in thermostat keeps the Kwikheat Iron at correct temperature for most efficient work—can't overheat—saves re-tinning time. Powerful, 225 watts, yet it's light (14 oz.)—well-balanced. Cool—safe—protected handle. Six interchangeable tip designs enable one iron to do most jobs. You cannot afford to overlook the Kwikheat Soldering Iron. Write for information—\$11 with choice of #0, 1, 2, 3 or 5 tip.



over a distance of about 50 miles while signals from the fixed station to the truck can be heard up to 80 miles. It is expected that 100,000 mobile units and 1000 land stations will be established in the months to come.

As illustrated, the installation has a control panel incorporating squelech and volume controls, a mi-



Operating simplicity is a prime feature of f-m installation in truck freighter. Designed by Motorola, the transceivers have been tested in trucks of Standard Freight Lines

crophone plug, and signal lights to indicate whether the unit is set to receive or transmit. The loud-speaker mounts above the windshield. Two cabinets house the transmitting and receiving equipment which is operated from the regular storage battery. A whip-type antenna, mounted on the cab roof, hinges to prevent breakage. Design is for ease of understanding by inexperienced personnel.



Pressure Sensing Unit Developed from Strain Gage

BASED ON THE PRINCIPLE of the familiar SR-4 strain gage, a new instrument known as the SR-4 pressure sensitive device has been introduced by Baldwin Locomotive Works. It is used to convert gas or liquid pressure to electrical energy for measuring, recording, and controlling purposes.

Designed in a series of ranges, the units have a top capacity of 0 to 20,000 psi and consistently reproduce an accuracy of 0.25 percent of full scale. This accuracy means that

DUAL DIVERSITY RECEIVERS

by **PRESS WIRELESS**

- Two identical superheterodyne receivers with isolating antenna matching network
- Five pre-tuned bands 2.4-23 megacycles
- Common crystal or self-excited HFO and BFO in thermostatically controlled oven
- Interlocking diversity AVC action
- Four diversity antenna combinations
- Electronic "eye" tuning indication
- Local and remote dial control
- Self contained power supply
- Cabinet rack and 19" panel construction

ENGINEERING BULLETIN SENT ON REQUEST

PRESS WIRELESS, INC.

Executive and Sales Office, 1475 BROADWAY, NEW YORK 18

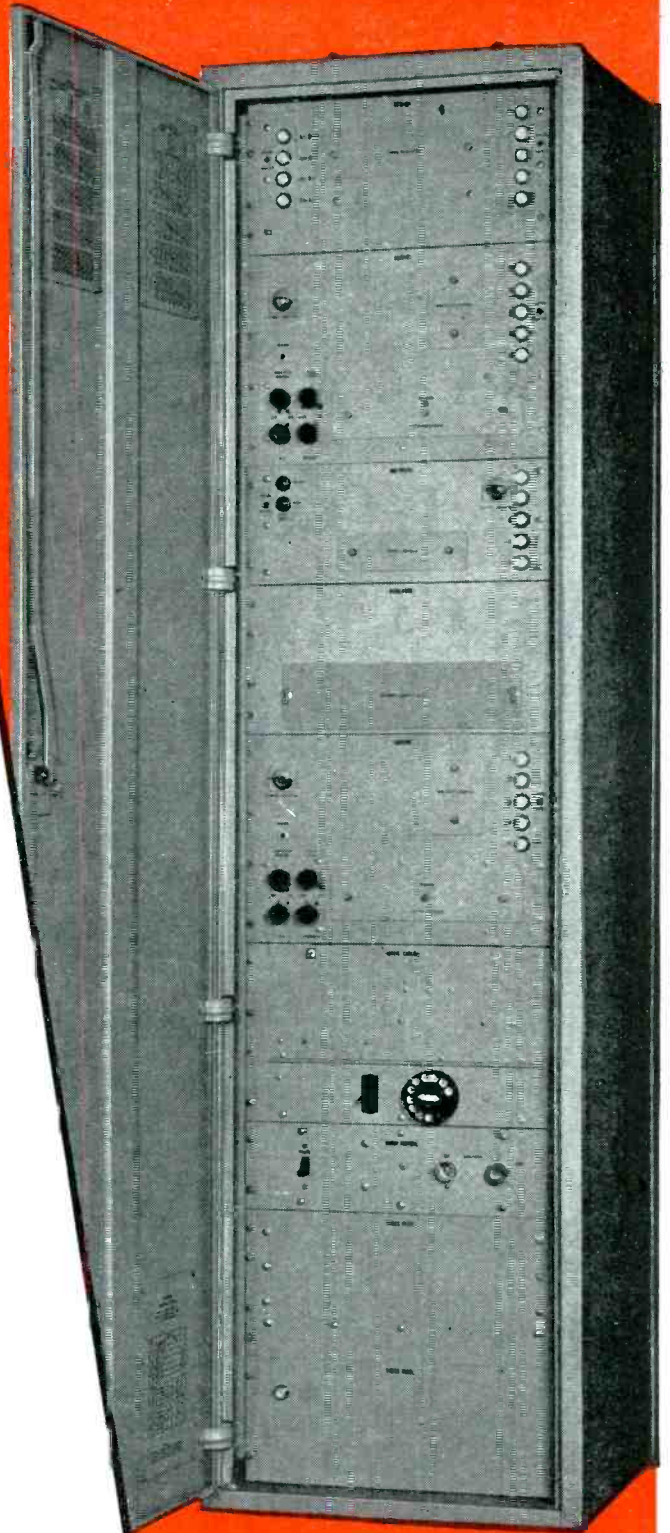

DUAL DIVERSITY RECEIVER
Press Wireless Model 5019A



Awarded to our Hicksville, L. I. plant for outstanding achievement in war production.

PARIS · BUENOS AIRES · RIO DE JANEIRO · MONTEVIDEO · MANILA · BERNE · SANTIAGO DE CHILE · NEW YORK · SHANGHAI · LOS ANGELES · LONDON · HAVANA

Controlled
Brilliance...
Thanks to a
**MALLORY
VARIABLE
RESISTOR**

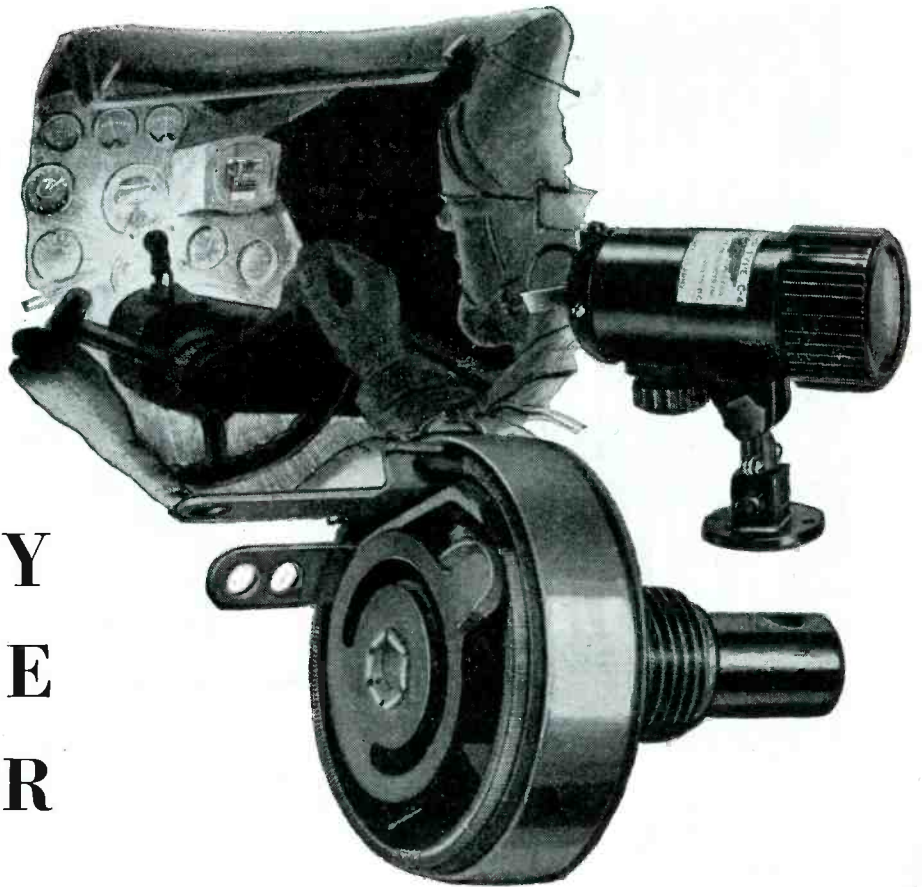

CONTROLLING the brilliance of this small cockpit lamp, made by Standard Aircraft Products, Dayton, Ohio, is a variable wire wound Mallory Resistor.

This lamp, used as an auxiliary light to illuminate the instrument panel or any area in the cockpit, is only $1\frac{3}{4}$ " in diameter and $5\frac{1}{16}$ " long. To control it, a standard Mallory Resistor of the C type was selected because of its compact size and precision construction . . . rugged enough to operate efficiently even when subjected to extreme vibration. In this application, a 50 ohm unit is being used for 12 volt operation, and a 200 ohm unit for 24 volt operation.

Standard C type Mallory Variable Resistors are available from 6 to 15,000 ohms at 2 watts. Other Mallory variable resistors are available in ratings from 2 to 9 watts, and from 0.5 to 150,000 ohms resistance in single and multiple units. Variable carbon resistors range from 5000 ohms to 9 megohms. Fixed and adjustable wire wound resistors are manufactured in a broad range of resistances, rated from 10 to 200 watts.

Complete details covering resistors, capacitors, switches, power supplies and other standard precision electronic parts are in the Mallory catalog. Ask your nearest Mallory Distributor for a copy, or write us today.

Make it a policy to consult Mallory for engineering assistance while your designs are still in the blueprint stage.

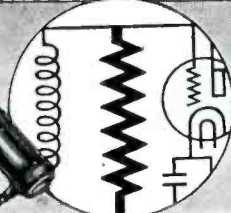

P. R. MALLORY & CO., Inc., INDIANAPOLIS 6, INDIANA

P. R. MALLORY & CO. Inc.

MALLORY

FIXED AND VARIABLE
RESISTORS

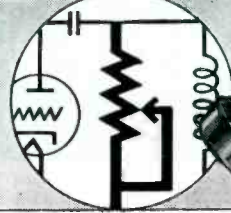
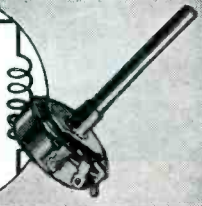

ADVANTAGES OF THERMOPLASTIC

There are fourteen practical advantages of thermoplastic insulation over older types of construction . . . advantages which PLASTIC engineering now makes possible at what, in most cases, is NO PRICE PREMIUM. Check them yourself: 1. Superior aging properties, 2. High resistance to oxidation, 3. Low moisture absorption, 4. High dielectric strength, 5. High tensile strength, 6. Resistance to flame, 7. Flexibility at low temperatures, 8. Resistance to abrasion, 9. Resistance to chemicals, 10. Resistance to oils and greases, 11. Ease of installation, 12. Increased capacity, 13. Attractive appearance, 14. Broad color range. Remember . . . when you're thinking of PLASTIC you're thinking of US!

Thermoplastic insulation specialists . . . producing a complete line from fine wires to heavy power cables . . . serving: Public Utilities, Radio, Electronic, Appliance and Instrument Manufacturers, Telephone Companies and Contractors.

PLASTIC

W I R E & C A B L E NORWICH CONN
 C O R P O R A T I O N

Full Range

HIGH AND LOW FREQUENCY
REPRODUCTION IN ONE ASSEMBLY!



HORIZONTAL SOUND DISTRIBUTION 80°

TRU-SONIC CO-AXIAL SPEAKER

The Tru-Sonic Co-Axial Speaker combines a high frequency metal diaphragm reproducer and a low frequency paper cone reproducer, mounted together with the dividing network in a single, compact assembly, 15" in diameter and 9" in depth giving a horizontal sound distribution of 80 degrees. Outstanding for custom quality, and excellence before the war, the Tru-Sonic Speaker is finer than ever, but is available at a lower price, because of quantity production. Available now! Write for illustrated brochure.

Licensed under Western Electric Patents

STEPHENS MANUFACTURING CO.

10416 NATIONAL BLVD.
LOS ANGELES 34, CALIF.

PRESSURE SENSING UNIT

(continued)

the devices can be used for hitherto impossible operations.

A fine filament of wire bonded to a hollow metal core is the heart of the device. The gas or liquid pressure to be measured is applied against this core. Increasing pressure stretches the filament and causes measurable changes in its electrical resistance. Resulting current changes are amplified and used to actuate a control system or they are read on an indicating instrument. Stretch of one-millionth of an inch can be detected.

The unit is hermetically sealed and has an inbuilt compensator to cancel out the effect of any such extraneous force as temperature may produce. Size of the complete device is only one in. diameter by 5½ in. long.

• • •

Railway Communications on 2660 MC

APPLICATION of nearly superhigh frequencies to railway communication has been announced by the Chicago, Rock Island Railroad. The system now being installed on the Chicago Division was developed as a result of experimental work conducted by E. A. Dahl of the Rock Island and H. H. Willis of the Sperry Gyroscope Co.

Communication between engineer and conductor is provided by transmitters and receivers equipped with press-to-talk hand sets, installed in

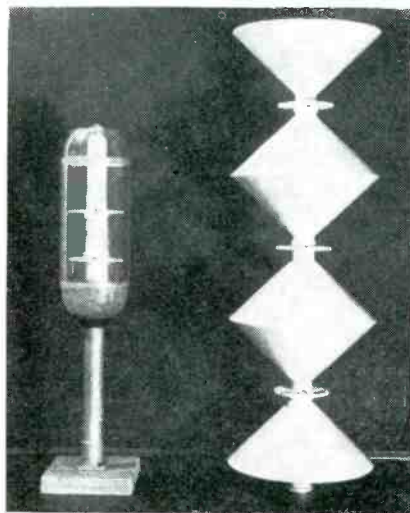

Two of the antennas used in experiments conducted on 2660 mc for railroad radio

are **7** heads
better than **1**?



VICTORY'S*

Engineering Staff

and 6 Consulting Engineers
work together... to give you

BETTER MOLDED PLASTICS!

If your post-war product demands injection molding to closest tolerances (like those required in the work we have done for the Armed Forces), you'll find VICTORY* completely equipped to do a better job quickly, and at the lowest possible cost consistent with finest craftsmanship. Now is the time to plan with our engineers and their consultants, so that your problems can be solved *before* you are ready to market your product.

Member: Society of the
Plastics Industry



Automatic Injection Molding

Small and large parts
UP
TO **17-OZ. SHOTS**

Lumarith, Tenite,
Fibestos, Plastacele,
Crystallite, Lucite,
Ethyl Cellulose,
Polystyrene, Lustron,
Styron, Cellulose Acetate
and others... all molded
to your exacting
specifications.

*VICTORY MANUFACTURING COMPANY

1724 W. Arcade Place, Chicago 12, Ill.
ESTABLISHED 1930

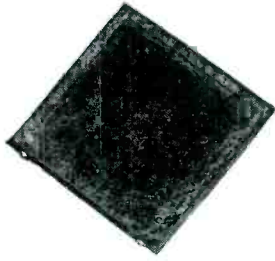

6kv — .5 mfd — weight 27 oz.
size 6" x 6" x 1/2" thick.



8kv — .03 mfd — weight 19 oz.
size 6" x 6" x 7/16" thick.



8kv — .012 mfd — weight 6 oz.
size 6" x 3" x 1/4" thick.



3kv — .0028 mfd — weight .5 oz.
size 3" x 2" x 1/16" thick.



3 1/2 kv — .00167 mfd — weight .4 oz.
size 3" x 1" x 1/16" thick.

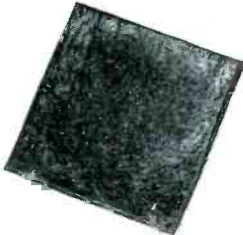

6kv — .0025 mfd — weight 1 oz.
size 6" x 1 1/2" x 1/16" thick.

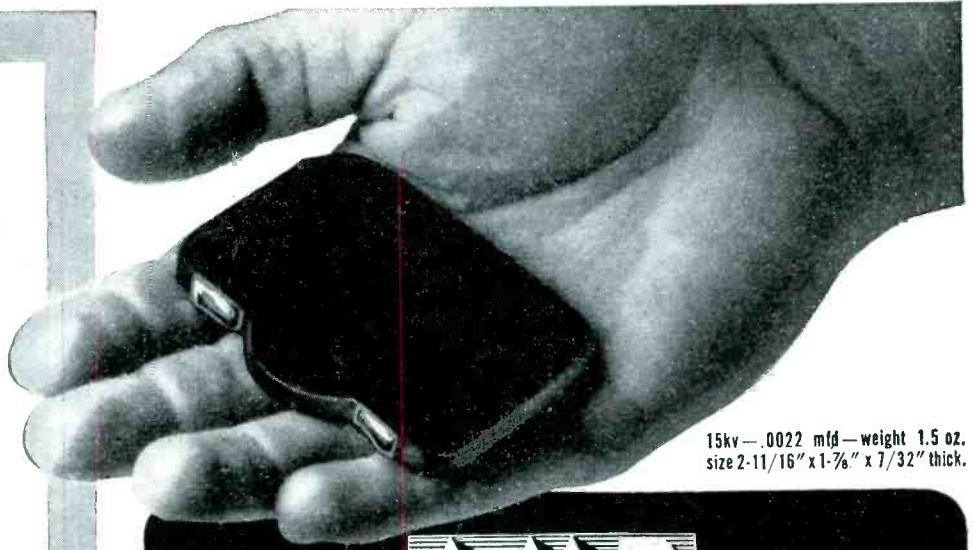

15kv — .0022 mfd — weight 1.5 oz.
size 2-11/16" x 1-7/8" x 7/32" thick.



HIGH-VOLTAGE CAPACITORS FOR RADAR AND SIMILAR APPLICATIONS

The new AMP high-strength dielectric, and a special fabrication technique give AMP Capacitors these outstanding advantages:

Approximately 25% lighter in weight; approximately 25% smaller —

AMP Capacitors are smaller and lighter than any other type of high-voltage capacitors of equal capacity and voltage. High dielectric strength refractory film plus special molded and bonded construction reduce size and weight and eliminate necessity of usual can and oil filler.

A 15 kv., 0.0022 mfd. unit measures only 2-11/16" x 1-7/8" x 7/32" and weighs only 1.5 oz.

Minimum losses —

Complete molding and bonding of unit protects against edge breakdown and corona.

Peak performance at high temperatures —

AMP Capacitors operate effectively at higher temperatures than ordinary capacitors. Minimum capacitance drift—less than 0.015% per degree C. over a range of —60° to +100° C.

High voltage operation —

Dielectric sheets are homogeneous, and not limited to size, permitting use of very high voltage stresses per mil without corona. High voltage units can be made in one piece instead of usual assembled sections.

AMP High Voltage Capacitors are made to specification. Send specific information concerning your application. A careful analysis of your requirements will be submitted by our engineers.



AIRCRAFT-MARINE PRODUCTS INC.
1521-53 NORTH FOURTH ST., HARRISBURG, PENNA.

In Canada: DAVID C. ORROCK, 1405 Bishop St., Montreal, Que.
F. N. ADAMS, 726 Homer Street, Vancouver, B. C.
F. MANLEY CO., 43 Victoria Street, Toronto, Ont.

SELENIUM



COPPER
SULPHIDE

offer you these advantages:

They are **COMPACT — SILENT — DEPENDABLE**
TROUBLE-FREE — RUGGED — and

They are **ADAPTABLE** for power outputs from
Milliwatts to Kilowatts.

Many rectifier applications, heretofore considered impractical, have been devised by B-L Engineers. It is more than likely that they can be of assistance in solving your problems of converting AC current to DC... Write for Bulletin R38-a.



THE BENWOOD-LINZE COMPANY

1815 LOCUST STREET

ST. LOUIS 3, MO.

Long distance telephone CEntral 5830

DESIGNED FOR DISCRIMINATING MANUFACTURERS

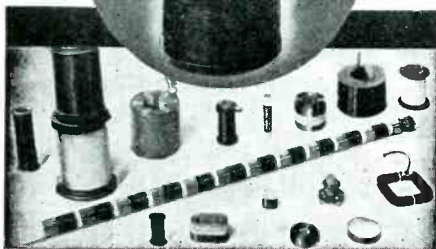

Leakproof

ENAMELED
MAGNET
WIRE

A product, resulting from many years of research in the field of fine wire manufacture, that meets the most rigid requirements of radio and ignition coils. A new coating method gives a smooth, permanently-adherent enameling, and mercury-process tests guarantee perfect uniformity. Great flexibility and tensile strength assure perfect laying, even at high winding speeds. If you want reduction in coil dimensions without sacrificing electrical values, or seek a uniform, leakproof wire that will deliver extra years of service, this Hudson Wire product is the answer.

Also manufacturers of high grade cotton and silk covered wires, cotton and silk coverings over enamel coated wires, and all constructions of Litz wires. A variety of coverings made to customers' specifications, or to requirements determined by our engineers. Complete design and engineering facilities are at your disposal; details and quotations on request.



Winsted
HUDSON WIRE CO.
Division
WINSTED • CONNECTICUT



CAPACITY...
for the hard-to-do

When the assembly of your product requires a special fastener or cold-forged product, call on our consultant service to help you at no obligation to you. We are equipped to manufacture cold-forged specialties in a wide range of metals, sizes and designs, in large or small quantities. In most instances, too, you'll find that cold-forging your special part represents a saving.

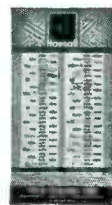

This Decimal Equivalents wall chart is accurate to four places and signalled in three colors. Yours at no cost or obligation. Just send us your name, title and address.

See our Catalog in Sweet's File for Product Designers

**JOHN HASSALL
INC.**

*Specialists in Cold-Forging
Since 1850*

**150 Clay Street
Brooklyn 22, N. Y.**



Boost the Performance

OF YOUR EQUIPMENT

with

RAYTHEON VOLTAGE STABILIZERS

THE PRECISION, accuracy and dependability of much electrical equipment are impaired by varying supply voltages.

If varying power supply handicaps your equipment why not install magnetic-type RAYTHEON VOLTAGE STABILIZERS? Long-proved, job-rated, and designed to meet practically any installation need, they are *boosting performance* in a wide variety of electrical equipment in many useful applications.

Get these principal operating advantages:

- Control of output voltage to within $\pm\frac{1}{2}\%$ of 115 or 230 V.
- Stabilization at any load within rated capacities.
- Quick response. Stabilizes varying input voltage within 1/20 second.
- Entirely automatic. No adjustments. No moving parts. No maintenance.

Read the complete story in our Bulletin DL48-537. Write for your copy today.

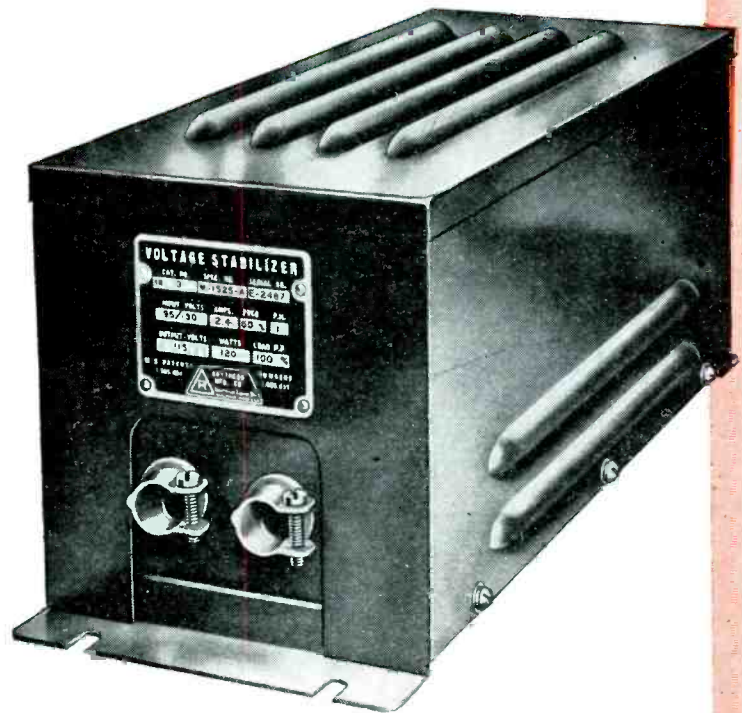

For Radio • Television • Communications
Radar • Motion Pictures Sound Recording
Electronic Devices • Constant Speed Motors
Production Machinery • Signal Systems
X-ray Equipment • Testing and Laboratory
Equipment.



HANOVIA

HERMETICALLY SEALED

R. F. CHOKES

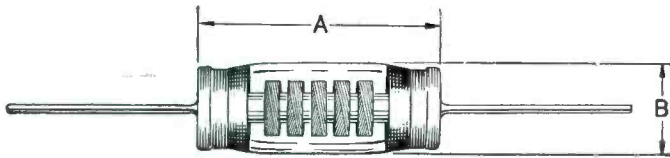

MILLI-HENRIES	A	B
1.0	1-3/4"	5/8"
2.0	1-3/4"	5/8"
2.5	2"	5/8"
5.0	2"	11/16"
10.0	3"	11/16"

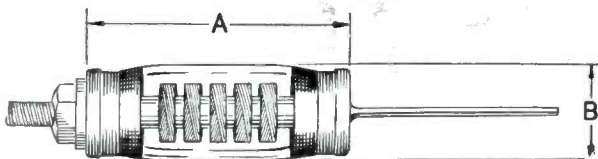

AVAILABLE IN ABOVE TWO FORMS
RATED AT 125 M.A. FOR ALL SIZES

*Complete information on these and
other Hanovia Chokes on request.*

HANOVIA

CHEMICAL & MANUFACTURING CO.

Industrial Division

Dept. E-17

Newark 5, N. J.

engine and caboose on freights, and engine and coach on passenger trains. Continuous contact with wayside stations is assured by relay stations placed along the right-of-way, and operated in conjunction with a carrier telephone system.

Ten watts of r-f power at 2660 mc, frequency modulated, is obtained from liquid cooled klystrons of the power-amplifier type. A fundamental frequency of approximately 4.92 mc is obtained from a

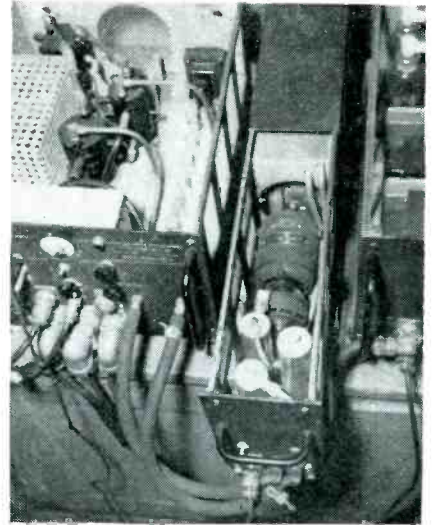

Microwave (2660-mc) transmitter and receiver developed by Sperry Gyroscope Co. engineers. The liquid-cooled klystrons at far left multiply ten times to produce the final frequency

crystal controlled oscillator. This is tripled twice, doubled and tripled again before being fed to a klystron frequency multiplier that raises it ten times to the carrier frequency.

Specially designed antennas, fed by stub-supported concentric lines, concentrate the radiated power into a pancake-like field. Consistent results have been obtained in practice where the trains were operating in tunnels or in deep gorges.

• • •

Ship-search Radar for Troopships

SAFE AND SPEEDY return of servicemen from overseas is the objective of a current program of installing ship-search radar equipment on transport vessels. All new bottoms as well as those not previously so equipped are having Models SO-1

turbo

INSULATIONS

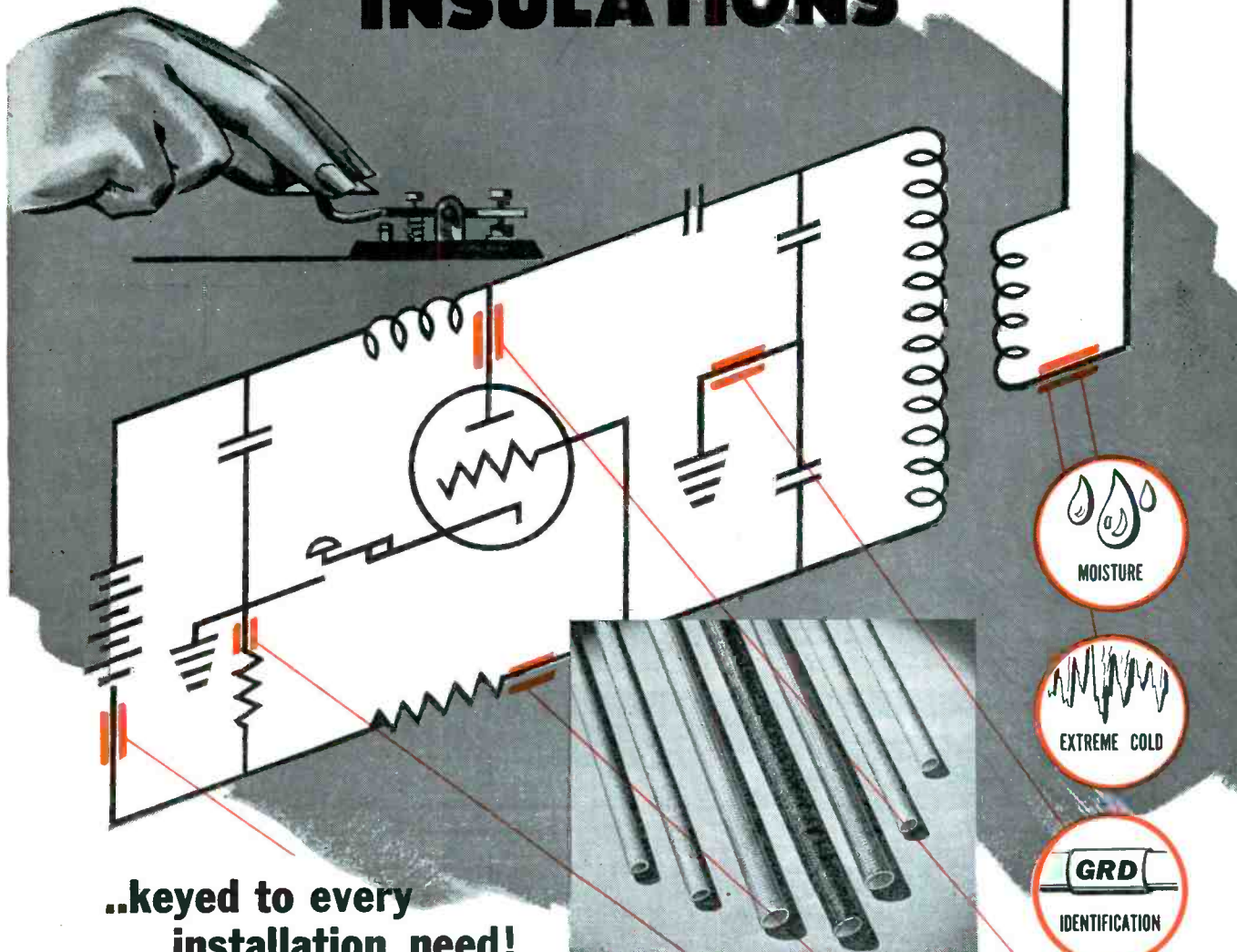

..keyed to every installation need!

Electronic communication circuits are a proving ground for electrical insulation. The varied conditions imposed—high voltage, heat, climatic exposure, battery acid, fumes, etc.—make several insulations, each with specific characteristics, essential. To meet these diversified requirements, TURBO engineers have developed four types of sleeveings that assure unflinching operation under any given operating condition. Each is supplied in a full range of colors and sizes that speed installation and simplify maintenance.

FLEXIBLE VARNISHED OIL TUBING: offers immunity to corrosive fumes, acid, alkalis and most solvents, with enduringly high dielectric values. It is impervious to moisture and non-hygroscopic.

VARNISHED GLASS TUBING: capable of functioning in high ambient temperatures—enclosed motors, unventilated areas, and general heavy duty installations.

WIRE IDENTIFICATION MARKERS: two types—sleeve type that slips directly over pipes, tubes, conductors; and tab type with flexible flag attached to sleeve. Both available in any marking.

Write today for free Specimen Board with samples and sizes of each.

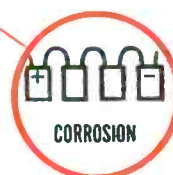
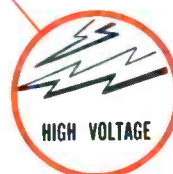

TURBO



WILLIAM BRAND & CO.

276 Fourth Ave., New York 10, N. Y. • 325 W. Huron St., Chicago 10, Ill.

Compression Molded
PLASTIC
PRODUCTS

★ Here at Rogan, you are invited to avail yourselves of our complete knowledge and long experience in all phases of plastic molding. Our staff of trained experts will be glad to assist you with your plastic problems, no matter how involved or comprehensive.

In addition to compression molding, we also offer an exclusive "deep relief" branding process that goes a long way toward reducing the cost of plastics that must bear markings, lettering or other descriptive matter.

Write for facts on this lower cost, combination service today.

ROGAN BROS.

Compression Molders and Branders of Plastics
 2003 S. MICHIGAN AVENUE • CHICAGO 16, ILLINOIS



A Better Service
Born of Our
Wartime Experience

With the nation engaged in all-out war, transportation became a factor of dominating importance. Every form of shipping was summoned into action. Railway Express, equipped to deliver nationwide service in peacetime, was suddenly called upon to use its complete resources in equipment and organization to cope with the most pressing demands in history. During the first six months of 1945, the Government express traffic was 42 times heavier than for the entire year of 1939.

Gun, Tank and Engine Parts, Serums and Drugs... Urgent and strategic materiel had to move speedily and accurately, and in tremendous volume. At the same time the fast and uninterrupted flow of raw materials and finished products to and from manufacturing plants was a wartime essential.

Camp and Base Express Offices... The personal package traffic between homes and camps meant millions of shipments daily. Fully equipped Express offices handled this important feature of wartime service.

Blood Units... High speed handling and special refrigerator containers saved thousands of American wounded. Over 8 million pints of blood were shipped in this manner by Express.

Ration Books and Tokens... More than 2 1/2 million pounds of ration books, and ration tokens by the billions were delivered to their destinations through 23,000 Express offices.

War Dogs for the K-9 Corps... The highly technical service of handling and shipping the nation's war dogs was assigned solely to Railway Express, and performed with signal success.

The above is a partial summary of wartime Express service. Today, with the return of peace, we are adding to our facilities all of the lessons learned in that historic period. We appreciate your cooperation and tolerance during the wartime days. We promise, in the not too distant future, a service superior to any we have rendered during our long nation-wide record.



Toroids..
 by
DX

Doughnut Coils for electronic and telephone purposes. High Permeability Cores are hydrogen annealed and heat treated by a special process developed by DX engineers. Send us your "specs" today—ample production facilities for immediate delivery.

DX RADIO PRODUCTS CO.
 GENERAL OFFICES 1200 N. CLAREMONT AVE., CHICAGO 22, ILL., U.S.A.

DX COILS
 "the heart of a good receiver"

ELECTRICAL CONNECTIONS

At Low Cost...

FOR SMALL OR LARGE QUANTITIES!



NEW BURNDY **HYTOOL**

Simple, compact, and relatively inexpensive, the Burndy HYTOOL (Cat. No. Y10R) provides new economies in making small wire connections . . . *regardless of quantities.*

In addition, each connection made is uniformly high in *mechanical strength* and *electrical efficiency* . . . because of the Burndy indent method, and Burndy's one-piece, pure-copper connector design. Here are the outstanding features of this HYTOOL:

1. Large jaw opening simplifies operation and speeds up work.
2. Foot-pedal leaves both hands free for fast, uninterrupted production.
3. Multiple die accommodates connector sizes 18, 14 and 10, with or without insulation grips, for wire sizes 22 to 10 inclusive . . . no 'setting-up' required when changing.
4. Economical for short runs . . . high production and low-cost on long runs.
5. Provides *uniform* indent, assuring uniformly strong, efficient connections.
6. Price: \$50.00 complete with die set. F.O.B. factory.

Also available for pneumatic operation. For full details, get in touch with the Burndy representative near you, or write, Burndy Engineering Co., Inc., 107-L Bruckner Blvd., New York 54, N. Y.

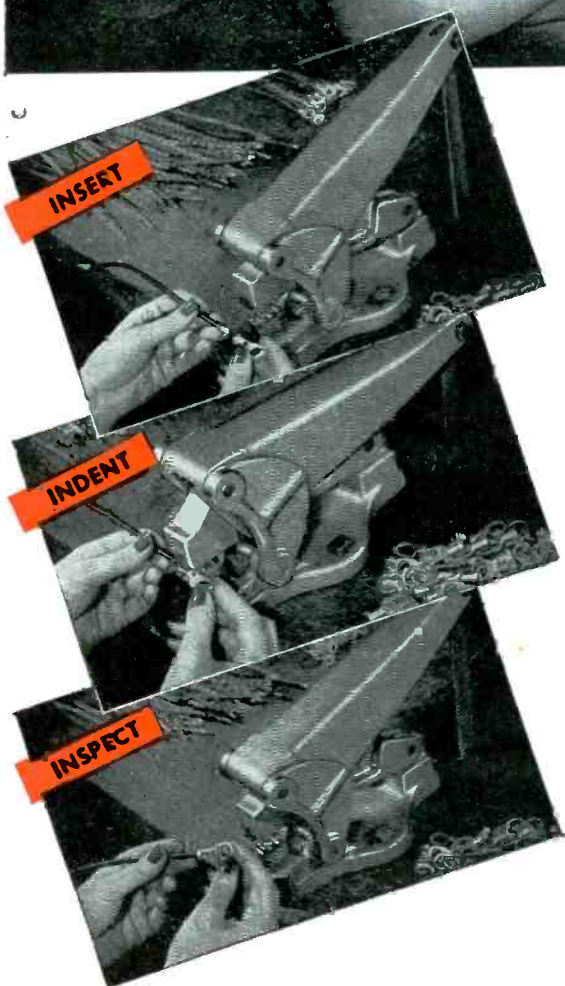

Headquarters for
CONNECTORS
Burndy



FIRST AWARD . . . JUNE 23, 1944

FIRST RENEWAL WITH STAR . . . DEC. 1E, 1944

SECOND RENEWAL WITH STAR . . . MAY 26, 1945



IMMEDIATE DELIVERY
METAL CHASSIS, CABINETS
TERMINAL BOARDS
AND STAMPINGS
To Your Specifications

A complete, expertly-manned tool and die shop enables Insuline to give almost immediate delivery on anything a manufacturer might require... from a lug to a gigantic transmitting cabinet... in quantities and to specifications.

The rest of the Insuline plant is equally well equipped to serve the nation's manufacturers. Batteries of high-production machinery are available to turn out such items as chassis, metal boxes, cabinets, terminal boards, and special stampings of all kinds.

Moreover Insuline can produce the item you require from beginning to end, all within the walls of the Insuline plant.

If you have a production problem, an Insuline Engineer will be glad to discuss it with you. If you prefer, send your specifications and we will send an accurate estimate by return mail.



insuline
CORPORATION OF AMERICA

QUALITY PRODUCTS SINCE 1921

INSULINE BUILDING • LONG ISLAND CITY, N. Y.

SHIP-SEARCH RADAR

(continued)

and SO-8 radar put in by Raytheon field engineers assisting Navy supervisors. That company has been the sole producer of both SO and SG microwave radars.

The SO type is a small modified version of the SG which finds a place on all combatant ships of the U. S. Navy. The SO system has been applied to thousands of land-

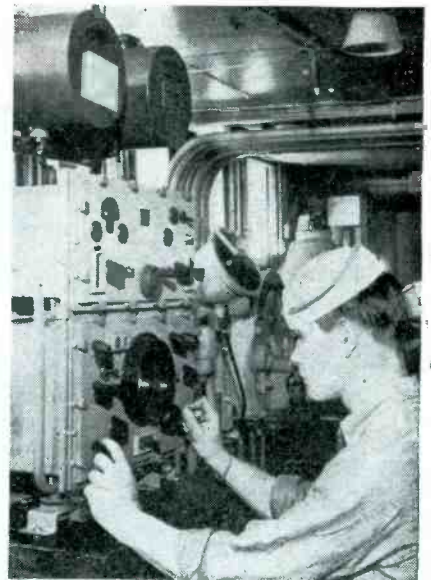

Installation of a type SO radar in the pilot house of a troopship is shown in this Signal Corps photograph. Raytheon gear of this model is being installed in troopships for speedier ocean crossings

ing craft, PT boats, attack transports, auxiliaries, and patrol craft.

As used in the present transport of troops, the gear saves time in the ocean crossing because the ships' speed does not have to be reduced in fog or darkness, collisions and delays are eliminated, and the vessels can get in and out of ports regardless of weather or the time of day.



High-Frequency Aircraft Ignition System

THE SCHEMATIC DIAGRAM shows a high-frequency aircraft ignition system which was successfully flown last year on one engine of an AAF B-24 bomber at Vandalia, Ohio. Further tests are being made on B-24's at the Smyrna Army Air Base, Smyrna, Tenn.

Voltage at approximately 1200 volts is generated in the magneto, distributed, converted at the mani-

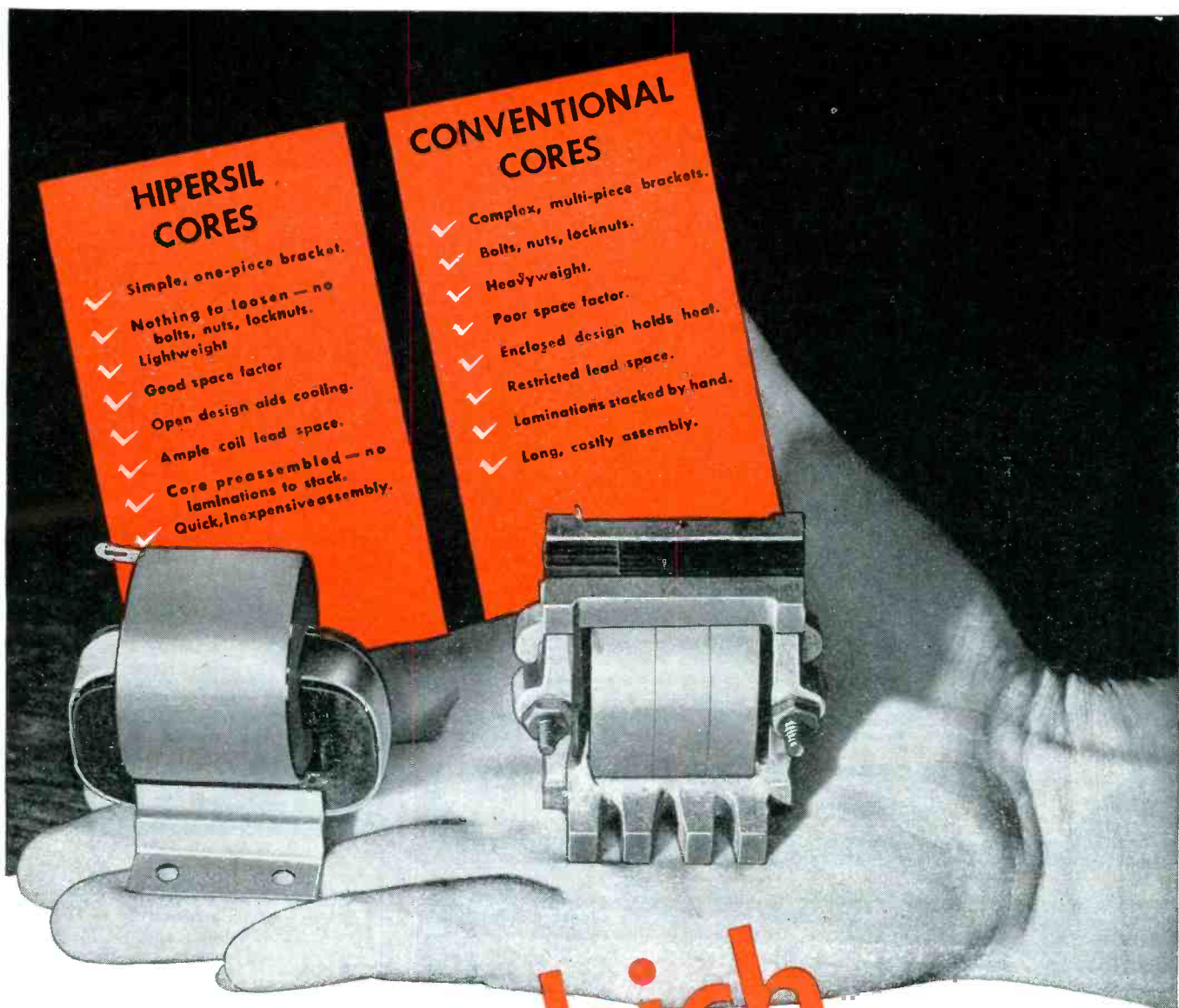

HIPERSIL CORES

- ✓ Simple, one-piece bracket.
- ✓ Nothing to loosen — no bolts, nuts, locknuts.
- ✓ Lightweight
- ✓ Good space factor
- ✓ Open design aids cooling.
- ✓ Ample coil lead space.
- ✓ Core preassembled — no laminations to stack.
- ✓ Quick, inexpensive assembly.

CONVENTIONAL CORES

- ✓ Complex, multi-piece brackets.
- ✓ Bolts, nuts, locknuts.
- ✓ Heavyweight.
- ✓ Poor space factor.
- ✓ Enclosed design holds heat.
- ✓ Restricted lead space.
- ✓ Laminations stacked by hand.
- ✓ Long, costly assembly.

which

is a better answer to communications requirements?

Which offers the most advantages in your present—or future—applications?

If space... weight... ease and cost of assembly... are factors at all, the answer is plain: HIPERSIL Cores can make a tremendous difference in simplifying manufacture, as well as in providing important improvements in performance.

HIPERSIL—the high-permeability

silicon steel with $\frac{1}{3}$ greater flux-carrying capacity—opens up new possibilities in electronic transformer design and manufacture. Full data on HIPERSIL characteristics and the advantages of Type “C” Cores may suggest new and better answers to your problems. Contact your Westinghouse representative or write Westinghouse Electric Corporation, P.O. Box 868, Pittsburgh 30, Pa. J-70466

Westinghouse
PLANTS IN 25 CITIES . . . OFFICES EVERYWHERE
HIPERSIL
*Registered trade mark



AVAILABLE FOR PROMPT DELIVERY

Hipersil Type “C” Cores are available for prompt delivery in a complete range of sizes, as required, and in five lamination thicknesses: 29 gauge, 5 mil, 3 mil, 2 mil and 1 mil.

Laboratory
Standards

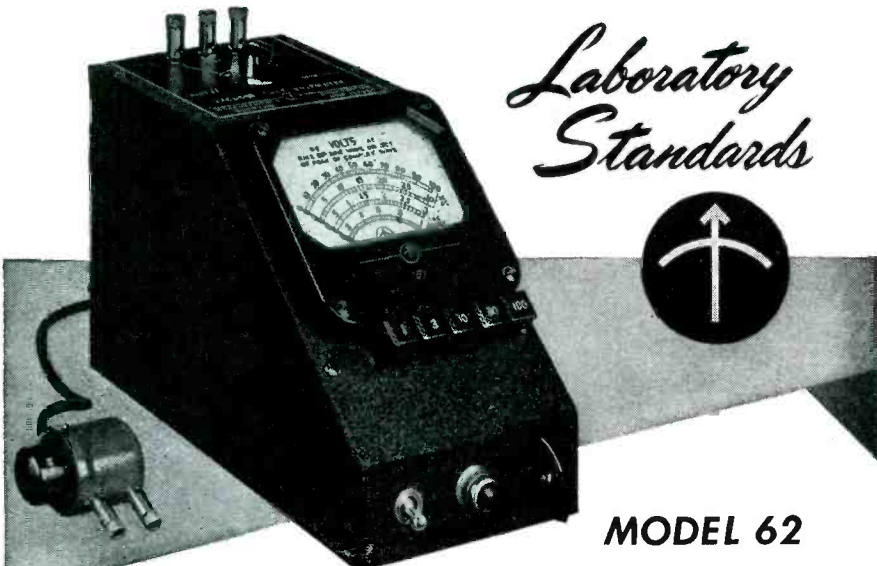

MODEL 62

VACUUM TUBE VOLTMETER

SPECIFICATIONS:

RANGE: Push button selection of five ranges—1, 3, 10, 30 and 100 volts a. c. or d. c.

ACCURACY: 2% of full scale. Useable from 50 cycles to 150 megacycles.

INDICATION: Linear for d. c. and calibrated to indicate r.m.s. values of a sine-wave or 71% of the peak value of a complex wave on a. c.

POWER SUPPLY: 115 volts, 40-60 cycles—no batteries.

DIMENSIONS: 4¾" wide, 6" high, and 8½" deep. **WEIGHT:** Approximately 6 lbs.

PRICE: \$135.00 f.o.b. Boonton, N. J.

Immediate Delivery

MEASUREMENTS CORPORATION
BOONTON, NEW JERSEY

WEAR RESISTANT

NON-CORROSIVE

NON-ABRASIVE

PERMOPIVOTS

NON-MAGNETIC

SUPER-POLISHED

Yes, Extra Value!

Long after the ordinary pivot has worn out you'll find PERMOPIVOTS in the prime of life—faithfully keeping precision instruments precise! It's all due to the special PERMOMETAL tip—the ideal osmium alloy. . . . Made to your specifications.
Write for information!

PERMO
INCORPORATED

6427 RAVENSWOOD AVE., CHICAGO 26
MANUFACTURING METALLURGISTS

RESISTANCE WIRE

ALLOY "A": Nickel-chromium alloy, resists oxidation at extreme temperatures. Essential for operating temperatures up to 2100° F. Also used for cold resistance. Resists chemical corrosion by many media. Non-magnetic; specific resistance, 650 ohms/C.M.F.

C. O. JELLIFF MFG. CORP.
123 PEQUOT AVE. • SOUTHPORT, CONN.

RESISTANCE WIRE

ALLOY "C": Nominally contains 60% nickel, 15% chromium, and balance iron. High resistance to oxidation and corrosion. Widely used in resistances for radio and electronics, industrial, and domestic equipment. Operating temperature up to 1700° F. Specific resistance 675 ohms/C.M.F.

C. O. JELLIFF MFG. CORP.
123 PEQUOT AVE. • SOUTHPORT, CONN.

RESISTANCE WIRE

ALLOY "180": Nickel-copper alloy with resistivity of 180 ohms/C. M. F. Widely used for resistor elements up to 750° F. (400° C). For radio controls, magnets, rheostats and voltage control relays.

C. O. JELLIFF MFG. CORP.
123 PEQUOT AVE. • SOUTHPORT, CONN.

RESISTANCE WIRE

ALLOY "45": Alloy of 55% copper, 45% nickel with a constant electrical resistance over wide range of temperatures. Specific resistance 294 ohms/C.M.F.; temperature coefficient 0.00002 ohms per degree F; 32 to 212 degrees range. Used in winding of precision resistors.

C. O. JELLIFF MFG. CORP.
123 PEQUOT AVE. • SOUTHPORT, CONN.

RESISTANCE WIRE

KANTHAL: Exclusive manufacturers of KANTHAL, an outstanding achievement in resistance-wire development. Now available—complete data upon request.

C. O. JELLIFF MFG. CORP.
123 PEQUOT AVE. • SOUTHPORT, CONN.

Note: All alloys are produced in high-frequency type furnaces, and are furnished bright, dull or oxidized finish, also with enamel, silk, or cotton insulation.

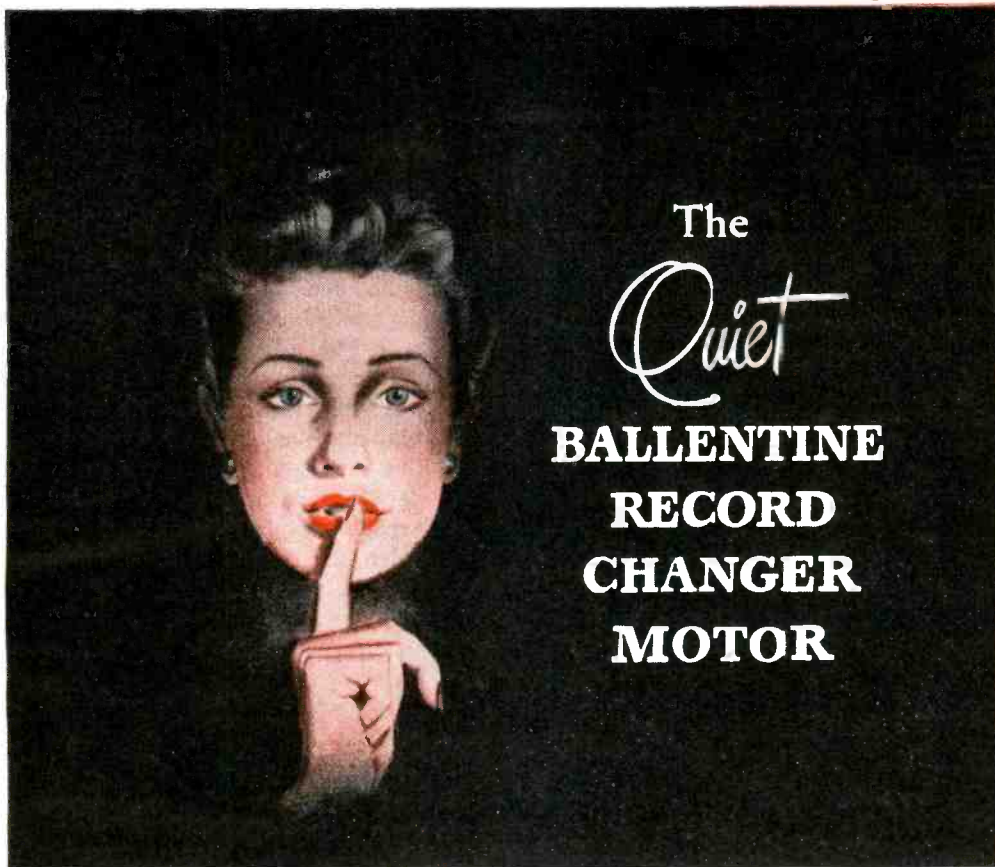

The
Quiet
**BALLENTINE
RECORD
CHANGER
MOTOR**

The *Quiet Ballentine* Changer Motor
has these four characteristics achieved by advanced
design, skilled engineering and precision manufacturing

- Lowest Rumble
- Highest Efficiency
- Most Compact Design
- Longest Life

The *Quiet Ballentine* Changer Motor is recommended
to record changer manufacturers seeking to provide
the ultimate in performance.

RUSSELL ELECTRIC COMPANY

364 WEST HURON STREET • CHICAGO 10, ILLINOIS

Manufacturers of **BALLENTINE
RECORD CHANGER MOTOR**

Today's New Trend is toward Webster Electric Pickups

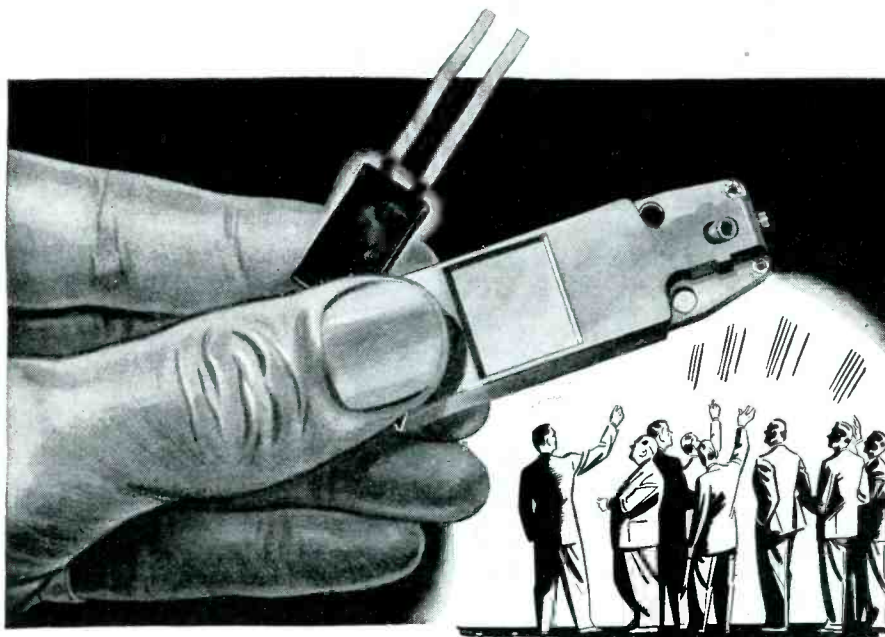

WEBSTER Electric Pickups have won their present position of pronounced preference among those who make, sell and own radio-phonograph combinations because of their superb performance.

These fine quality pickups are precision-built to meet the highest standards of tonal beauty in record reproduction. Sensitive, delicate, responsive . . . they cover the entire range of vocal and orchestral tone with unsurpassed clarity and fidelity. Despite a constantly increasing demand for Webster Electric Pickups and Cartridges, each one must meet the most rigorous inspection tests before it leaves the factory.

If you have not already standardized on Webster Electric Pickups for your present or planned line of fine radio-phonograph combinations, we urge you to consult with us on your needs without delay. Write us direct.

Keep Buying Bonds



(Licensed under patents of the Brush Development Company)

WEBSTER ELECTRIC

Racine, Wisconsin, U.S.A. • Established 1909 • Export Dept.: 13 E. 40th Street, New York (16), N.Y. Cable Address "ARLAB" New York City

"Where Quality is a Responsibility and Fair Dealing an Obligation"

fold ring into r-f at two to three million cps by an impulse-type frequency converter, delivered to the spark plug through a shielded coaxial line, and there transformed to about 10,000 volts for firing the plug. The final voltage step-up is performed in a small transformer sealed hermetically into the well of a standard aircraft spark plug.

The energy produced in this system has such a steep wave front that it is capable of igniting a cylinder charge despite fouled, leaded, or carbonized plugs, conditions which often arise from long periods of

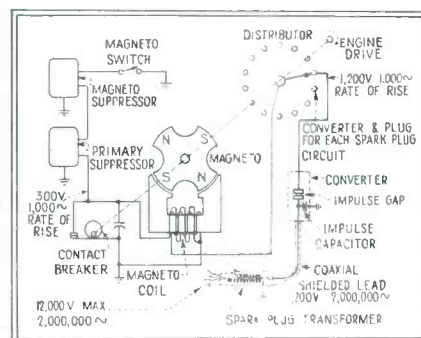

Circuit diagram of the high-frequency aviation ignition system. It will fire a spark plug shunted by 10,000 ohms resistance

idling, taxiing, or gliding. Inability of the pilot to get full power from the engine immediately under these conditions frequently causes forced landings. In tests, this circuit was able to fire plugs against a shunt resistance of 10,000 ohms where conventional systems begin to miss at 100,000.

Other advantages include increased engine output as a result of the possibility of using colder spark plugs without fear of misses from fouling; good high-altitude operation because of low-tension distribution; increased spark plug life since gap erosion is reduced by the low energy level; substantial reduction in radio interference; and a saving of 10 lb or more per engine.

Because the major portion of work to date has been directed to engines for large military aircraft, the possibilities for small personal planes and automobiles have not been explored as completely. However, the indications are that there may be many useful functions for

you can get to work with plastics

NOW

here's

HOW

Here's a new Dow plastic that gives you the rare opportunity to put your plastic plans to work—*RIGHT NOW!* Most plastics are still short. But this new Dow development—its durability and effectiveness proved in war—is now freely available for the many peacetime jobs that call for its unique qualities. It may be just the thing you need. Suggested applications include tools, electrical insulation, home appliances, sporting goods. Field experience and Dow research point unmistakably to a world of opportunities for new and profitable civilian applications. Full data is waiting for you. Push your plastic program—*NOW*—ask Dow about Styraloy at once!

STYRALOY

SOMETHING REALLY DIFFERENT IN PLASTICS

For better insulation, tool handles, and products as varied as scuff plates, floor mats and fittings or gaskets, Styraloy is the answer to tough service demands.

CHECK THESE PROPERTIES

High dielectric strength, low power loss; flexible and shock resistant from -90° to 212° F.; light weight; negligible water absorption; resists heat, many chemicals, permanent indentation and abrasion; easily machined.

THE DOW CHEMICAL COMPANY, MIDLAND, MICHIGAN

New York • Boston • Philadelphia • Washington • Cleveland • Detroit • Chicago
St. Louis • Houston • San Francisco • Los Angeles • Seattle



STYRON • STYRALOY • ETHOCEL
ETHOCEL SHEETING • SARAN • SARAN FILM

**MOVES
AIR**

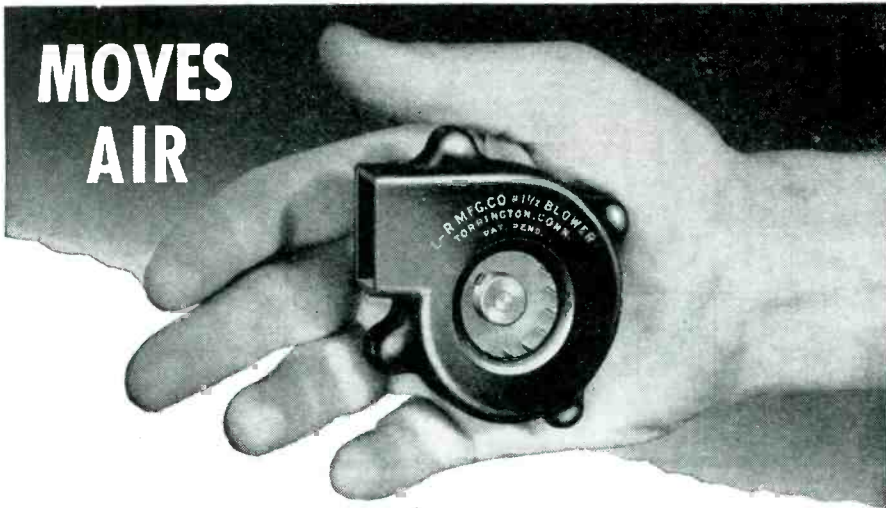

... 15 CUBIC FEET A MINUTE

The No. 1½* is one of many blowers manufactured by the L-R Mfg. Div. with C.F.M.'s at 8000 R.P.M. ranging from 15 to 270. They will outperform many larger types and where size and weight are factors, they solve cooling problems presented by electronic tubes or circuit components in airborne communication units as well as in many industrial applications.

*WEIGHT: 2 oz.; CAPACITY: 15 C. F. M. at 8000 R.P.M.; CONSTRUCTION: Housing of high impact phenolic plastic. Wheel is turbotype cadmium-plated steel; SIZE: 2¾" long x 61/64" wide x 2½" high.

L-R MANUFACTURING DIVISION OF

The **RIPLLEY** Company

13 NEW LITCHFIELD STREET TORRINGTON, CONNECTICUT

**FOR DISPENSING
MELTED
COMPOUNDS . . .**

This veteran Sta-Warm CN dispensing pot symbolizes thousands similar to it which have operated "for years without adjustment or failure."

All Sta-Warm electrically heated tanks, kettles and pots are built to rigid specifications which insure uninterrupted production regardless of the compound being melted.

Many feet (sometimes a mile) of resistance wire constitute the heating element in Sta-Warm tanks. This heating element, in a wide variety of circuits, blankets sidewalls and bottom of each tank or pot to give widest distribution of heat at black heat temperatures, thereby resulting in low wattage per square inch of tank surface and aiding the long useful life of the heater. Dependable thermostats assure maintenance of proper temperature having practical variation of plus or minus 5° F. Heating, melting or dispensing of compounds will be a problem to you no longer . . . if you specify "Sta-Warm." Why not inquire today for new bulletin 038W?

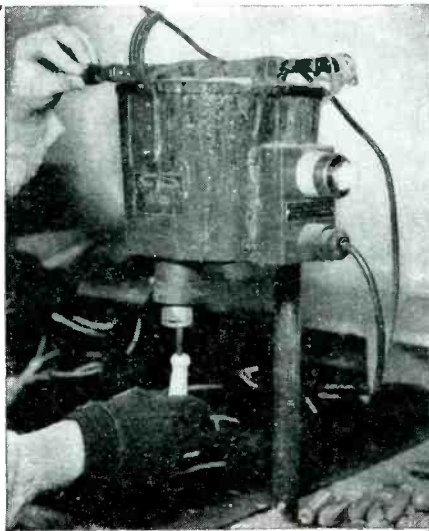

Of this 1 gal. Sta-Warm CN dispensing pot, the Kellogg Brush Mfg. Co. says "Your dispensing pots have operated in our plant for years without adjustment or failure." Pot is here seen loading brush handle with thermal chemical compound before inserting brush frame.

STA-WARM ELECTRIC CO.
1000 N. CHESTNUT ST. • RAVENNA, OHIO

**WIRE SO FINE
IT MUST BE
Magnified
TO BE SEEN**

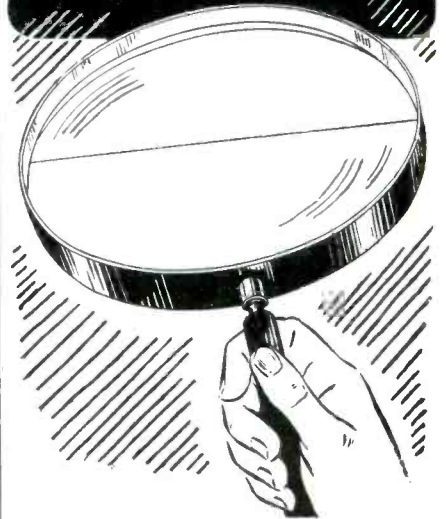

**WOLLASTON PROCESS
Wire as small as**

1 { OF AN INCH
100,000 } IN DIAMETER

. . . available in Platinum and some other Metals

.00001" is less than 1/30 the diameter of the smallest wire die commercially available. Yet our Wollaston Process wire (drawn in a silver jacket) closely meets your specifications for diameter, resistance and other characteristics.

This organization specializes in wire and ribbon of smaller than commercial sizes and closer than commercial tolerances. Write for List of Products.

SIGMUND COHN & CO.



44 GOLD STREET NEW YORK 7

**VARNISHED
FIBERGLAS-
AND - FIBER**

**DUPLEXED
VARNISHED
FIBERGLAS**

**SPECIAL THIN
SLOT
INSULATIONS**

3 IMPROVED SLOT INSULATIONS BY IRVINGTON

Irvington again sets the pace with three improved insulations:

Varnished Fiberglas-and-Fiber, that combines the heat and moisture resistance and high mechanical strength of flexible Fiberglas with the high insulating qualities of Irvington formulated varnish.

Duplexed Varnished Fiberglas, that furnishes added protection against high temperatures and dampness with two layers of varnished Fiberglas that are flexibly bonded together, providing increased dielectric and mechanical strength and improved cushioning effect.

Special Thin Slot Insulations, consisting of varnished Fiberglas, rayon, nylon or cambric, duplexed to rag paper, in extremely thin combinations which provide high dielectric insulations for narrow and shallow slots wherever space is limited.

With these three additions to its broad line, Irvington further increases its leadership in the production of slot insulations to meet all operating conditions and requirements. Complete co-operation in fulfilling your needs is freely offered. Write Department 46.

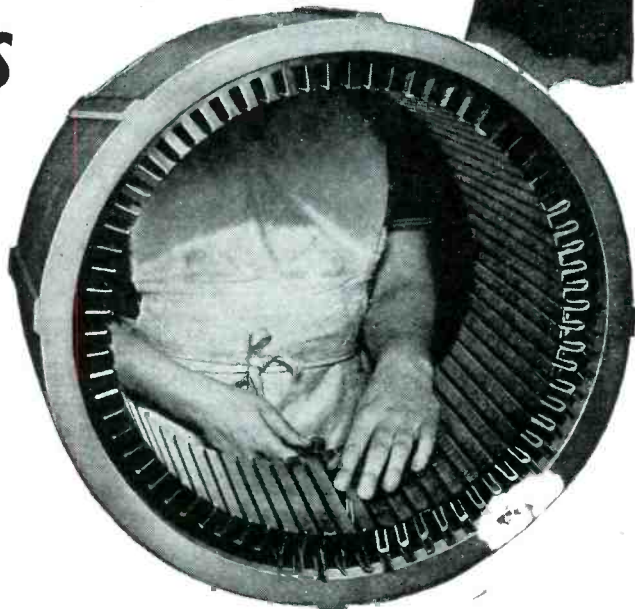

Other Irvington products include . . . insulating varnish, plastic tubing and tape, varnished tubing, varnished fabrics, varnished Fiberglas, wire markers, Cardolite Compounds.

IRVINGTON

VARNISH & INSULATOR CO.
Irvington 11, New Jersey, U. S. A.

LOOK TO IRVINGTON FOR CONTINUED LEADERSHIP IN INSULATION

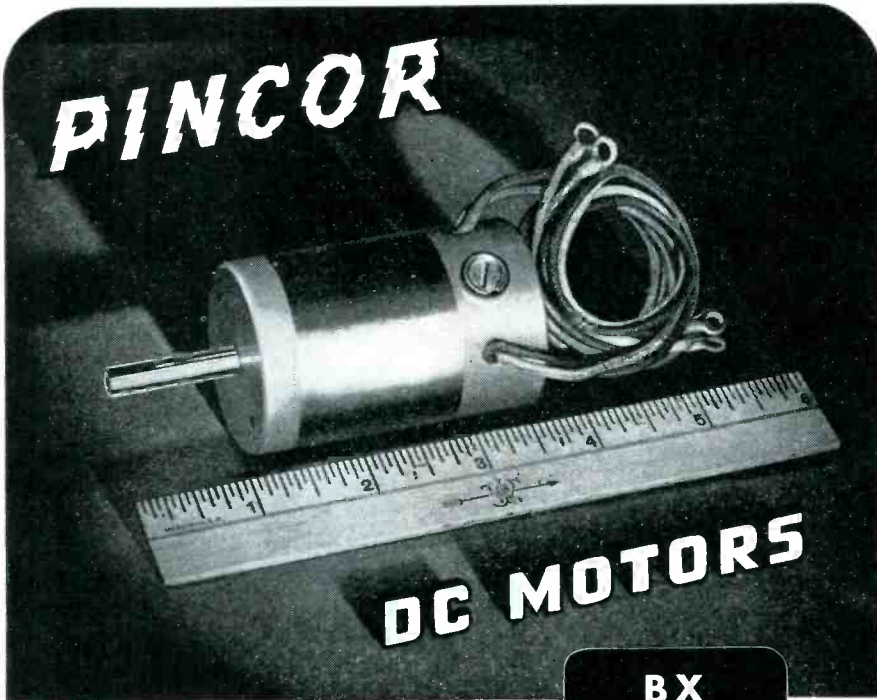

**BX
SERIES**

The urgent demand, in peacetime days, by the aircraft and radio industries for a compact, efficient D.C. motor was the challenge that led Pioneer to develop the Pincor BX series. Today Pincor BX motors flow from our plant in a steady stream to the producers of aircraft and radio equipment for the armed services.

Pincor BX motors, in their classification, meet the varied requirements of aircraft and radio manufacturers that demand light weight, compact motors for efficient and dependable application. Pincor BX motors are direct drive, ball bearing, high speed units wound for continuous or intermittent duty. Shunt, series or split series windings are for operation on 12 to 24 volt battery systems currently used and may be easily modified to meet your product demand.

Depend on these rugged Pincor quality-proven motors in the BX series. Send your problem to Pioneer engineers and let them put their years of experience to work for you. Consultation with these men will not obligate you in the least.

DYNAMOTORS • CONVERTERS
GENERATORS
POWER PLANTS • GEN-E-MOTORS



**PIONEER GEN-E-MOTOR
CORPORATION**

5841-49 DICKENS AVENUE CHICAGO 39, ILLINOIS

BUY MORE BONDS!

Export Office, 25 Warren Street, New York 7, U.S.A.
Cable Address: Simonrice, N. Y.

high-frequency ignition systems.

The development was derived from work done previously by Fred J. Hooven of Dayton, Ohio and was performed by P. R. Mallory & Co., which has concluded licenses with American Bosch Corp. and the Scintilla Magneto Division of Bendix Aviation Corp. with others under discussion for further development and manufacture.

• • •

**Direct-indicating Comparison
Bridge for Production
Testing**

DESIGNED FOR RAPID production testing where moderate accuracy is desired, the circuit shown in the illustration provides comparison of resistors, capacitors and inductors to a similar standard. It consists of an a-c slide-wire bridge and an electron-tube indicating circuit. The slidewire covers a range of approximately ± 50 percent of the value of the standard.

Three working standards are used in calibration of the gear: one of nominal value and one each of upper and lower desired limits. Low and high values can be differ-

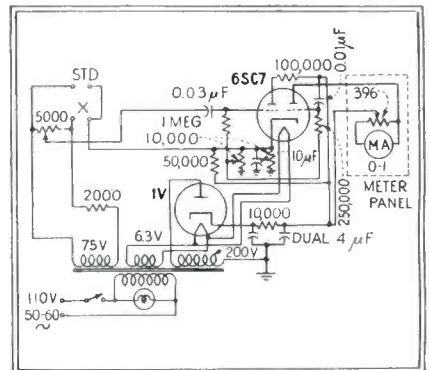

Schematic diagram showing use of type 1-V rectifier and 6SC7 null indicator in direct-indicating comparison bridge

ent. After adjustment, the separate indicating meter provides a within-limits reading up to a marked point on the scale or an outside-limits reading beyond. Thus the testing operator is not required to rotate dials or press buttons.

Accuracy of the equipment is largely dependent on the care with which limits are set as well as variations in line voltage. However, sensitivity and stability are such



from **BRASS** to **PLASTIC**
...a Change for the Better!

When Consolidated originally developed the transfer mold for this intricate Terminal Block (illustration A), provision was made for a multiplicity of threaded brass inserts—and while it meant no trouble for us to add two more inserts for the projecting switch stops . . . trouble did occur in actual service; it was difficult for the brass stops to maintain their functional accuracy.

As "Accuracy Headquarters," this problem became Consolidated's problem! . . . And in illustration (B) you now see the solution . . . plastic stops . . . integrally molded, to closest tolerance, right into the piece. According to customer's reports, this change proved eminently satisfactory!

We cite this as an example of Consolidated's flexibility. Our know-how with mold design, mold making and processing is such as to permit changes—incorporate improvements—and thus assure perfect performance.

The above is also indicative of Consolidated's desire to serve. Inquiries invited from those whose present problems or plans have reached the thinking-out stage. Consolidated guarantees your blueprint in plastic—the right plastic!

INJECTION
molding
TRANSFER
molding
COMPRESSION
molding

"YOUR BLUEPRINT IN PLASTIC"



Consolidated

MOLDED PRODUCTS Corporation
 307 CHERRY STREET, SCRANTON 2, PA.

Branches: NEW YORK • CHICAGO • DETROIT • BRIDGEPORT • CLEVELAND

"ALNICO"

PERMANENT MAGNETS

Specializing in the production of highest quality Alnico Magnets in all grades including new triple strength No. 5.

Production material checked to assure highest uniform quality of product.

Castings made to customer's special order on the basis of sketches or blueprints furnished.

Information and suggestions furnished on request.

GENERAL MAGNETIC

C O R P O R A T I O N

MANUFACTURERS OF HIGH COERCIVE MAGNETIC ALLOYS

2126 E. Fort Street

Detroit 7, Michigan

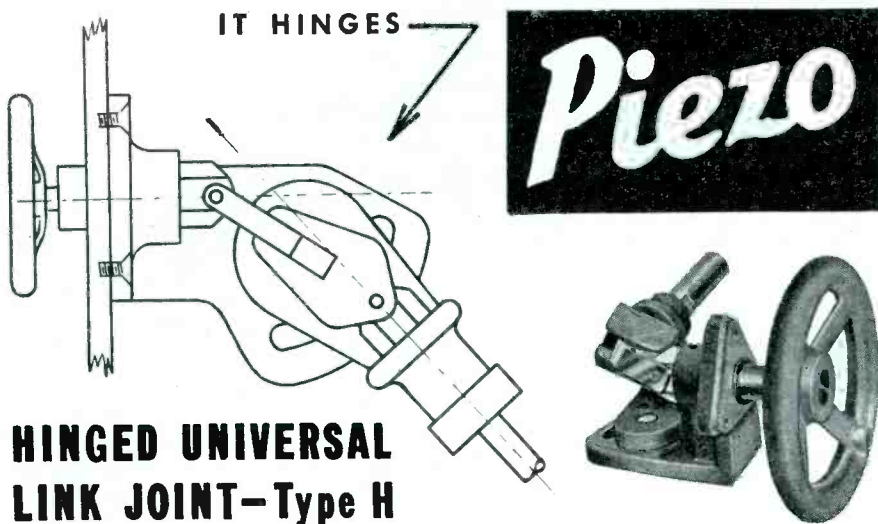

HINGED UNIVERSAL LINK JOINT—Type H

This Piezo universal link joint, new in principle, transmits motion around corners and permits operation of shafts at angles from 0° to 90°. Easily installed with solid shafting; flexing or backlash is negligible. The input and output shafts turn in exact angular rotation. It is recommended for operation of dial and rheostat controls, switches, variable condensers and transformers, coils, and other mechanical adjustments. Write for folder 45A giving complete data and specifications.

PIEZO MANUFACTURING CORPORATION

110 E. 42nd STREET, NEW YORK 17, N. Y.

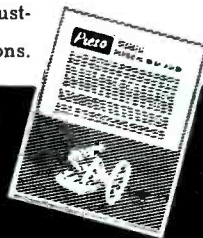

Stokes MICROVAC Pumps

HEART OF HIGH VACUUM SYSTEMS

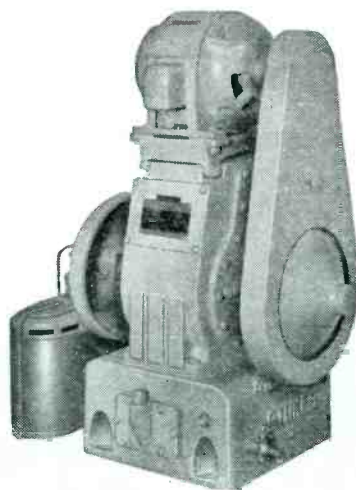

- Higher Vacuum (in the low micron range)
- High volumetric efficiency
- Low power requirement
- Complete discharge of air —no re-expansion
- Continuous dehydration of oil — no moisture to re-evaporate
- Discharges sudden slugs of liquid without injury
- Easily accessible, non-corrosive discharge valve
- Rugged, compact, simple construction
- Long life . . . negligible maintenance
- Five sizes—from 10 to 235 cu. ft. per min.

Stokes VACUUM GAUGES

(Patented Method Type)

Are Always Accurate



- Require no calibration
- Rapid readings
- Simple to operate—just tip and read
- Two models (AA) 0 to 5000 microns—(BB) 0 to 700 microns, with readings to 1/10 micron.

F. J. STOKES MACHINE CO.

6046 Tabor Road Philadelphia 20, Pa.

Stokes High Vacuum
PUMPS • GAUGES • EQUIPMENT

LARGE OR SMALL ... AmerTran!

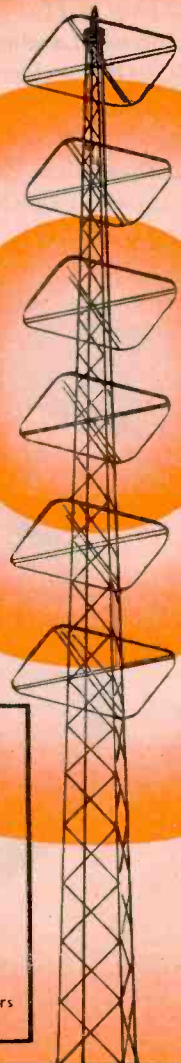

**SPECIFY
AMERTRAN
Components
in your
NEW
TRANSMITTER**

Rating: 74DB, Class B, Modulation Transformer .03-15KC, 12 KV D.C. Operating 51 K.V. Hi-potential.

- Modulation Transformers and Reactors
- Oil or Abestol Immersed Plate Transformers
- W Type Transmitter Transformers
- Transtat A. C. Voltage Regulators (Manual, Motor and Automatic Operation)
- Radio components
- Wave filters
- Rectifiers
- Transformers for Electronic Applications
- Air borne Transformers
- General Purpose Lighting and Power Transformers

There is an AmerTran Transformer for practically every transformer symbol in all electronic circuits. They range from units to fit in a microphone to the huge modulation and plate transformers used by large broadcasting stations. Whatever their size, they have one thing in common—the quality construction that has made AmerTran the leader in transformer manufacture for forty-four years. When writing for Bulletin state product in which you are interested.

AMERTRAN

REG. U. S. PAT. OFF.
MANUFACTURING SINCE 1901 AT NEWARK, N. J.

AMERICAN TRANSFORMER COMPANY
178 EMMET STREET, NEWARK 5, N. J.

Pioneer Manufacturers of Transformers, Reactors and Rectifiers for Electronics and Power Transmission



Case Histories

from the **RICHARDSON** files . . .

Problem: to produce a bearing that is strong, hard and yet able to absorb shocks and noise.

Solution: Richardson Plasticians designed a bearing composed of a wearing surface of graphitized Laminated INSUROK for strength and hardness, and live rubber for shock and noise absorption. It can operate with or without lubrication.

This is typical of the plastics problems handled by *Richardson Plasticians* almost daily. No two are exactly alike—but each is solved with the same “know how,” the same background of experience unique in the plastics industry. For in addition to molding and laminating famous INSUROK Precision Plastics, Richardson has complete facilities for molding bituminous plastics, rubber and rubber-plastics combinations—and, of course, all fabricating and finishing operations.

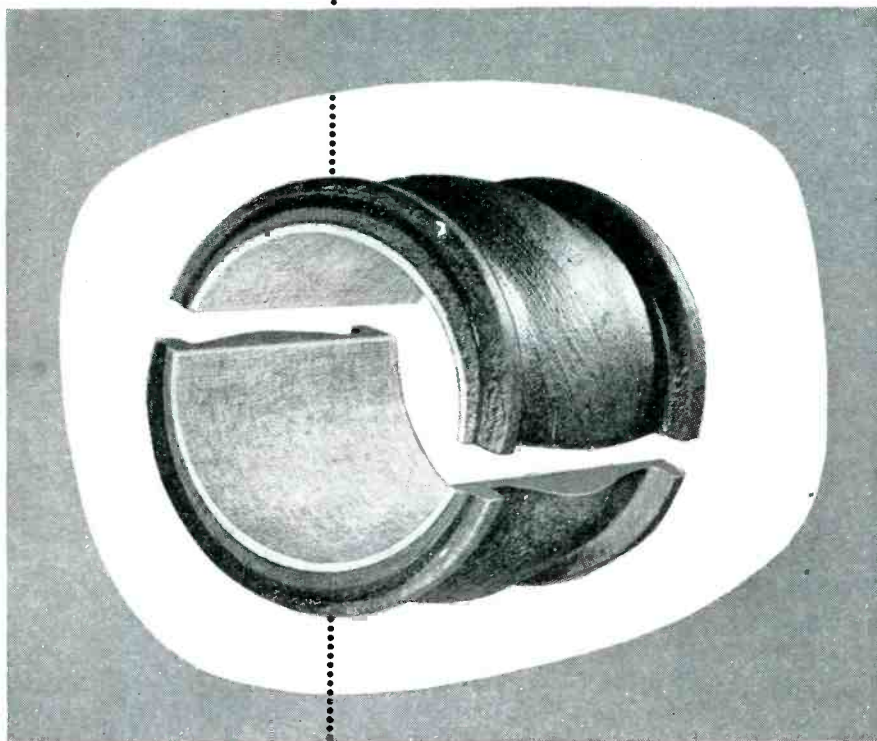

INSUROK Precision Plastics

The **RICHARDSON COMPANY**

LOCKLAND, CINCINNATI 15, OHIO FOUNDED 1858 Sales Headquarters: MELROSE PARK, ILL.

Sales Offices: NEW YORK 6 • CLEVELAND 15 • DETROIT 2

Factories: MELROSE PARK, ILL. NEW BRUNSWICK, N. J. INDIANAPOLIS, IND.

as to permit successful operation with limits set as close as ± 5 percent or as wide as ± 50 percent of nominal. As made by Industrial Instruments, Inc., the range of measurement on capacitance is from 0.0001 to 1.0 μf ; in resistance, from 2000 ohms to 20 meg; and in inductance, from 5 to 50,000 henrys.

Selsyn Indicating Systems for Remote Readings

BY F. WISK

Long Branch, N. J.

INDICATING SYSTEMS that provide readings remote from the scene of operations have found wide application in industry during recent years and have been used in many military equipments. In such systems, selsyn motors provide a convenient and flexible means of remote electrical position indication. A basic indicating system consists of a transmitter and receiver, with both units being electrically identical. The transmitter rotor is driven by external mechanical means and the receiver, at a remote point, indicates the position of the transmitter rotor. To understand the theory of operation of selsyn indicating systems a review of basic theory of the principles involved is in order.

Action on D-C and A-C

Referring to Fig. 1, coils *A* and *B* are placed in close proximity to each other. Assume that coil *A* is held in a stationary position and coil *B* is light and free to move if a force is exerted. If switch *S* is closed momentarily, a current will flow in coil *A* which in turn will be induced in coil *B*. Since the induced current in coil *B* will flow in the opposite direction to coil *A*, like magnetic poles will be set up as indicated and coil *B* will be repelled by coil *A*.

Referring next to Fig. 2, coil *A* is connected to a source of alternating current and creates induced current in coil *B* at the same frequency. The induced current in coil *B* is opposite in direction to coil *A*, hence in Fig. 2 coil *B* will be repelled by coil *A*. Although the magnetic poles of coils *A* and *B* are rapidly reversing they will still be opposing.

In Fig. 3 first assume that the

DC

DOW CORNING

SILICONES

increase permissible operating

temperatures by more than 100°C.

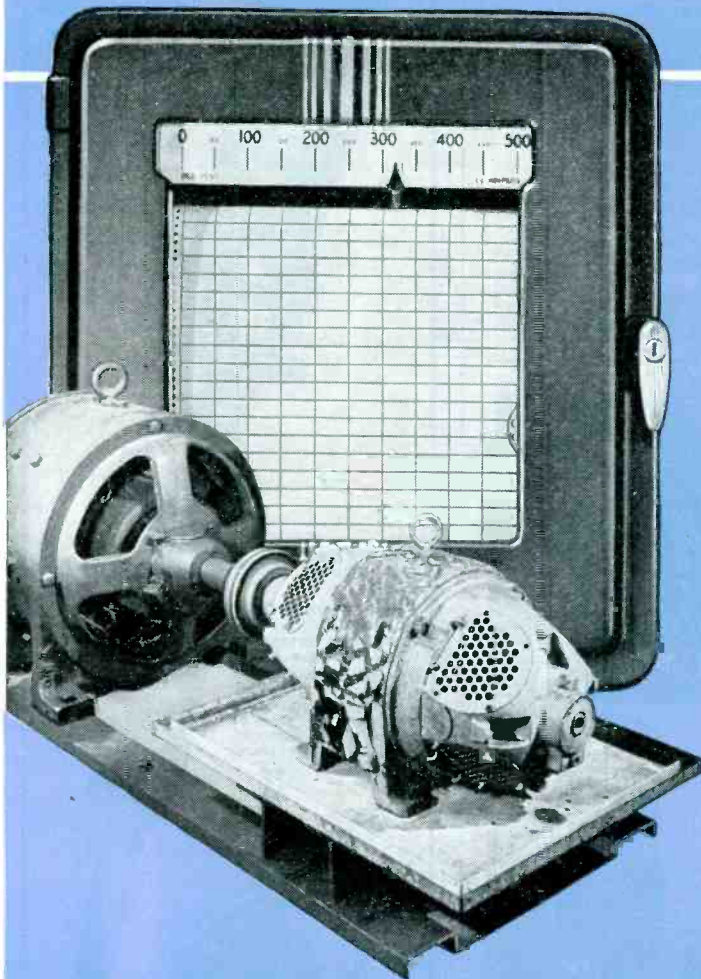

IN THE ELECTRICAL INDUSTRY, FOR EXAMPLE

This test motor wound with Silicone Insulation has been alternately saturated with moisture and operated at 310°C. (590°F.) by resistance, for a total of 2,000 hours with no sign of failure. Silicone Insulation means reliable and continuous operation under most adverse conditions.

DOW CORNING CORPORATION
MIDLAND, MICHIGAN
NEW YORK OFFICE: EMPIRE STATE BUILDING

Today many accepted engineering limitations are being swept away by revolutionary new Dow Corning silicone materials. Designers are making major product improvements—coupled with important economies—never before possible.

Here's a specific example. Dow Corning varnishes and resins—because of their unique resistance to high temperatures—make it possible to redesign or rewind electrical equipment for increased horsepower output per unit weight. At the same time they greatly prolong equipment life under adverse operating conditions and reduce overload failures and fire hazards.

The recent development of **IE 996**, a Silicone Varnish which cures at 300°F., enables any electrical maintenance or rewind shop to secure the greater operating economies of Silicone Insulation.

In other industries Silicone materials also make possible operations which were previously impossible or very expensive. Consult Dow Corning for particulars.

Dow Corning

FIRST IN SILICONES



How **PROGRESSIVE DIES** *Cut Costs*

GOAT PRECISE-FORMED STAMPINGS

Save Money in quantity production

New techniques in construction and use of high speed, automatic, single operation, multiple-stage, progressive dies, in conjunction with the GOAT Precision Feed (U. S. Pat. No. 2,250,520), make possible: higher production speeds, lower scrap losses, less tool maintenance, overall lower costs, and closer tolerances than ever before possible. On lots of 500,000 or more the savings are indeed worthwhile.

*Submit samples or drawings
for cost estimates*



GOAT METAL STAMPINGS, INC.
Affiliate of The Fred Goat Co., Inc.
314 DEAN STREET BROOKLYN, N. Y.

LET US
REDESIGN
FOR
STAMPING



THERMOSTATIC METAL TYPE **DELAY RELAYS** PROVIDE DELAYS RANGING FROM 1 TO 120 SECONDS

Other important features include:—

1. Compensated for ambient temperature changes from -40° to 110°F .
2. Contact ratings up to 115V-10a AC.
3. Hermetically sealed — not affected by altitude, moisture or other climate changes . . . Explosion-proof.
4. Octal radio base for easy replacement.
5. Compact, light, rugged, inexpensive.
6. Circuits available: SPST Normally Open; SPST Normally Closed.

WHAT'S YOUR PROBLEM? Send for "Special Problem Sheet" and Descriptive Bulletin.

AMPERITE CO. 561 BROADWAY
NEW YORK 12, N. Y.

In Canada: Atlas Radio Corp., Ltd.
560 King St. W., Toronto

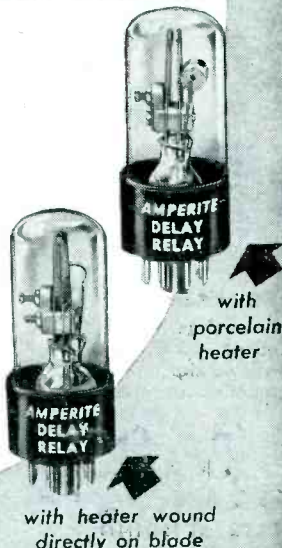

TEMPERATURE REGULATING STAND

This is a thermostatically controlled device for the regulation of the temperature of an electric soldering iron. When placed on and connected to this stand, iron may be maintained at working temperature or through adjustment on bottom of stand at low or warm temperatures.

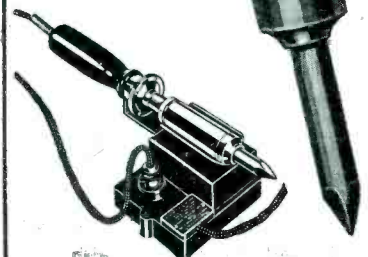

For further information or descriptive literature, write



107-1

**AMERICAN ELECTRICAL
HEATER COMPANY**
DETROIT 2, MICH., U. S. A.

Nothing Thin

about our wishes for you,

this first of peacetime Christmases

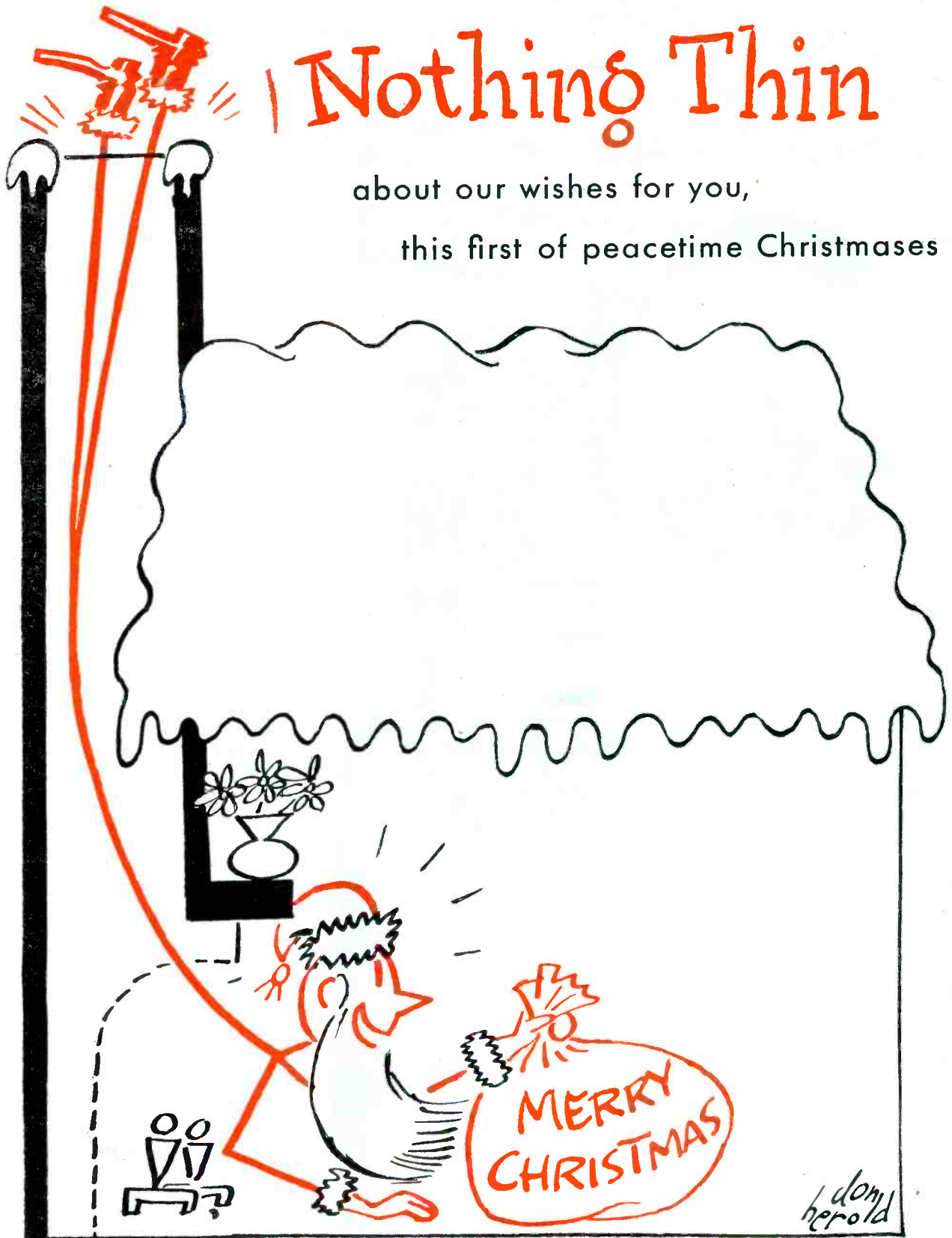

SPECIALISTS IN **THIN GAUGE** INSULATING PAPERS

SCHWEITZER PAPER CO.

142 MILLER STREET, NEWARK, N. J.
Plants: Newark, Jersey City, N. J., Mt. Holly Springs, Pa.
Research Laboratories: Chrysler Bldg, New York, N. Y.

ELECTRONIC AC VOLTMETER

with Logarithmic Scale

Percentage Accuracy of reading is uniform over entire scale!

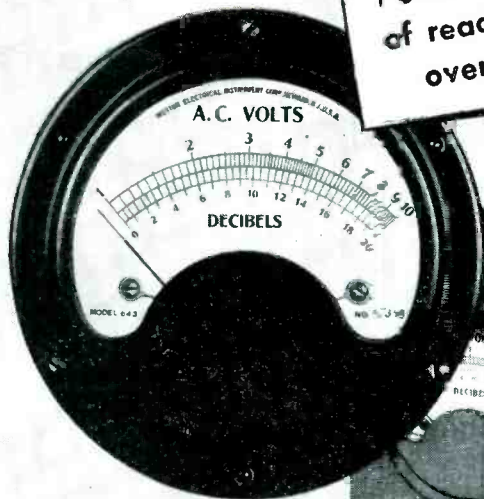

MODEL 300
ELECTRONIC
VOLTMETER

ACCESSORIES

MODEL 220 DECADE AMPLIFIER
MODEL 402 MULTIPLIER



Since its development in 1935 the Ballantine Electronic AC Voltmeter is the only instrument of its kind with a Simplified Logarithmic Scale.

The important feature of logarithmic scale indication in the Ballantine Voltmeter provides the same degree of accuracy at 1 as at 10. Also the simplicity of this scale reduces errors in visual observation, common with most multi-range instruments. Finally, the care taken in overall calibration combined with the inherent stability of the circuits used permits reliable readings within the 2% specified tolerance over the complete range of operation.

Write for descriptive  Technical Bulletin 5

BALLANTINE LABORATORIES, INC.
BOONTON, NEW JERSEY, U. S. A.

generator across coil A is operating and that the generator across coil B is turned off. Under these conditions, the same situation exists as in Fig. 2; coil A will repel coil B. If the generator connected across coil B is then used to supply current that is out of phase with

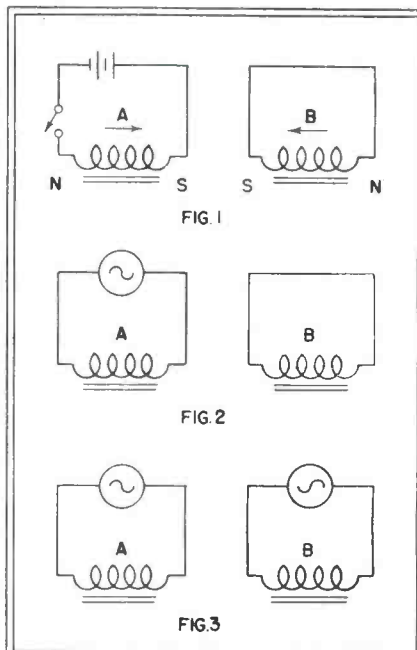

Figures 1 to 3 show the elementary steps in analyzing the operation of a selsyn indicating system

the induced current, enough current can flow in coil B to cancel the induced current and the coils will not repel or attract.

If the generator is adjusted to supply coil B with more current than the induced current, the magnetic poles of coil B will be reversed and the coils will attract, since the poles of coil B will then be reversed.

Principles

To summarize the action (Fig. 3), three important conditions exist:

1. With the generator supplying coil A operating, and the generator connected across coil B off, coil A will repel coil B.
2. With both generators operating and the generator across coil B supplying sufficient current to cancel the induced current in coil B, the coils will not repel or attract.
3. If the generator across coil B supplies a larger (out of phase)

3 POINTERS FOR FAILURE-FREE WIRE PERFORMANCE IN ELECTRICAL EQUIPMENT

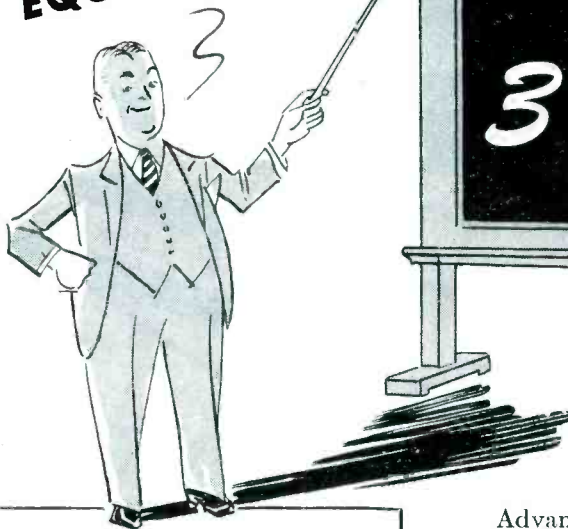

- 1 Wire-Plan Products in Design Stages
- 2 Double Check All Possible Operating Service Conditions
- 3 Install Rockbestos Permanently Insulated Wire and Cable

125 different permanently insulated wires, cables and cords developed by Rockbestos to meet unusual and severe operating conditions.

ROCKBESTOS FIREWALL RADIO HOOKUP WIRE

Sizes No. 22 to 4 AWG in 1000 volt rating, and No. 12, 14 and 16 AWG in 3000 volt.

The first lightweight, small diameter, flame-resistant hookup wire, designed in 1937 and widely used since in airborne and ground communication systems, electronic devices, instruments and apparatus. Operating temperatures range from 125° C. to minus 50° C. Also with tinned copper shielding braid and in twisted pair or tripled construction.

ROCKBESTOS TYPE CA LEAD WIRE

Has high-dielectric strength and moisture resistance for use where heat and humidity are encountered. No. 20 to 8 AWG solid or stranded copper, monel or nickel conductors insulated with synthetic tape and various thicknesses of felted asbestos finished in black, white or colors for coding purposes. Also with All-Asbestos insulation only, for high temperature applications where moisture resistance is not required.

ANOTHER NEW ROCKBESTOS FIREWALL CONSTRUCTION A 400° F. WIRE

War-developed Rockbestos High-Temperature Wire—with a maximum operating temperature of 400°F.—designed for jet propelled plane applications and circuits to hot-wing de-icers, fire detectors and extinguishers, and air conditioning and heating units where baking temperatures destroy ordinary insulation. Under continuous operation at rated temperature it retains its original dielectric strength and inherent resistance to heat and flame, and progressively improves in its resistance to moisture and abrasion. Now available for these and other severe applications. Write for complete information and samples.



Advanced wire-planning will tell you what you'll need in a wire to withstand high ambient and operating temperatures, abrasion, vibration, overloads, moisture, oil, grease.

Checking actual operating conditions and adding ample safety margins will help take care of the unusual service requirements that the product gets in operation.

Installing Rockbestos wires, cables and cords gives your products trouble-free wire performance under severe operating conditions.

Inherently heatproof and fireproof, *permanently insulated* Rockbestos has an *impregnated asbestos insulation* that withstands conductor-heating overloads and high ambients. It won't dry out, crack or bake brittle. Because the insulation resists oil, grease, moisture and alkalis, it won't rot, flow, bloom or swell.

Rockbestos wires, cables and cords are available in 125 standard constructions . . . each and every one has a *permanent asbestos insulation* that assures long-lived performance under severe conditions. And for applications where a standard won't do . . . Rockbestos Research will go to work on a "special" construction to meet your particular requirements. For samples, wire recommendations or wire assistance, write nearest district office or:

ROCKBESTOS PRODUCTS CORPORATION

430 Nicoll St., New Haven 4, Conn.

INVEST IN VICTORY BONDS

ROCKBESTOS RESEARCH

Solves Difficult Wiring Problems

New York Buffalo Cleveland Chicago Pittsburgh St. Louis
Los Angeles San Francisco Seattle Portland, Ore.

EISLER EQUIPMENT

..complete and diversified for every phase of electronic* manufacture!

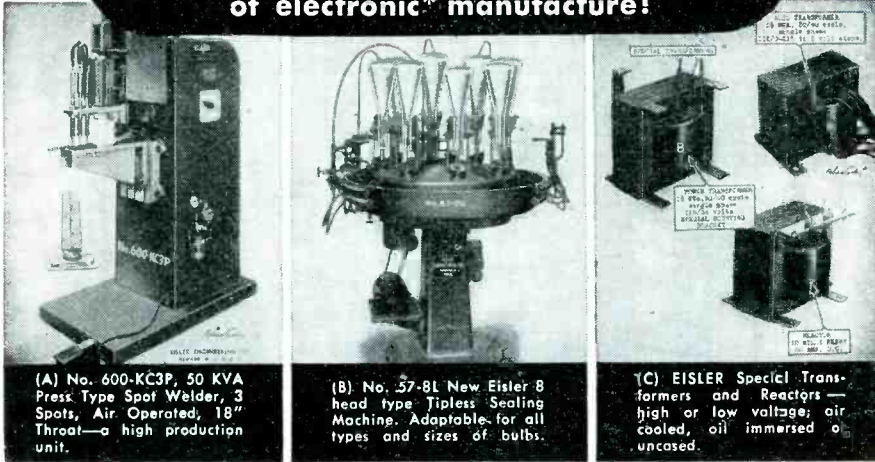

(A) No. 600-KC3P, 50 KVA Press Type Spot Welder, 3 Spots, Air Operated, 18" Throat—a high production unit.

(B) No. 57-8L New Eisler 8 head type Tipless Sealing Machine. Adaptable for all types and sizes of bulbs.

(C) EISLER Special Transformers and Reactors—high or low voltage; air cooled, oil immersed or uncased.

The CHAS. EISLER line of specialized electronic tools, machines and devices is complete and diversified. Included are innumerable types of welders—spot, seam, butt, rocker, arm, pneumatic and special types. Also included are hundreds

of devices for vacuum tube manufacture—glass tube cutters, slicers, stem and sealing machines as well as an all-inclusive line of transformers for every industrial and general need.

* EISLER serves 99% of American vacuum tube producers today. Write for completely illustrated catalog.

CHAS. EISLER EISLER ENGINEERING CO.

751 SO. 13th STREET (Near Avon Ave.) NEWARK, NEW JERSEY

New INLAY PROCESS

ELIMINATES NAME PLATES ON FRONT PANELS

A proven method for placing durable characters on metal panels, chassis, etc.

- ★ Inlaid baked enamel characters, protected by background finish; resistant to abrasion and salt spray; guaranteed to pass 50 hour salt spray test. NOW available in luminous characters, if desired, either phosphorescent or fluorescent.
- ★ Front panel will match finish of cabinets.
- ★ Recommended and endorsed by scores of manufacturers of electronic, sound and communication equipment.

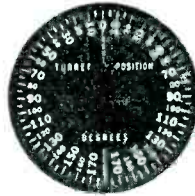
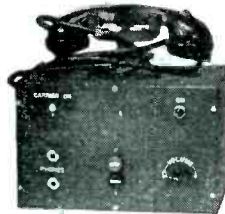

PROMPT DELIVERIES—Send us your bare fabricated steel and within two weeks we will return it finished and marked to your complete satisfaction.

SCREENMAKERS

64 FULTON STREET • NEW YORK 7, N.Y.
Tel.: REctor 2-9867

ALSO...
SILK SCREENING on front panels and chassis, either metal or plastic. Sharp clear characters durably printed on finished or unfinished surfaces.

RESISTORS
CONDENSERS
CONTROLS • WIRE
TRANSFORMERS • CABLE
HEADPHONES
RELAYS • SWITCHES
SOLDERING IRONS
BATTERIES • TUBES
TOOLS

RIGHT OFF THE SHELF!

Radio-Electronic Parts and Materials...

Dalis carries an outstanding stock—most items right off the shelf.

IN A HURRY!



'Phone, wire, or write...

H. L. DALIS

Wholesale Distributors
RADIO-ELECTRONIC SUPPLIES & PARTS
17 Union Square
NEW YORK 3, N. Y.

Phones: ALgonquin 4-8112-3-4-5-6-7



FOR THOSE WHO SEEK

*The Finest
Cored Solder in the World*

Ersin Multicore Solder contains 3 cores of non-corrosive Ersin Flux and provides just that extra rapidity of fluxing action which ensures a precision standard of consistently reliable solder joints. Only 3 independent cores of flux, evenly distributed across the cross-section of the solder wire, can give this extra efficiency. The cost of an individual solder joint in electronic apparatus is so little and each joint so vital that it must pay you to buy the Best cored solder—Ersin Multicore.



**3 CORES OF ERSIN
THE ACTIVE NON-
CORROSIVE FLUX**

Ersin, which is contained in the 3 cores of Multicore Solder, is a pure high grade rosin which has been subjected to a complex chemical process to increase its fluxing action to the highest degree without impairing the well known non-corrosive and protective properties of the original rosin. In effect, rosin as a flux suffices only as an agent to avoid oxidation during soldering, whereas Ersin will not only remove surface oxides, but also prevent their formation during the soldering operation. NO extra flux is required. The flux does not tend to run out of cores, so there is always a supply available for the next joint. The utmost economy of flux and solder is achieved.



ALLOYS

Five standard antimony free alloys are available. Ersin Multicore Solder is supplied in bulk quantities in any other tin-lead alloy to special order. Recently 45 tin and 55 lead alloy has been in most demand for electronic equipment. Colour coding of reels and packages makes different alloys instantly recognisable.

GAUGES

Ersin Multicore Solder is made in a wide range of gauges. Standard gauges supplied are from 10 S.W.G. - 22 S.W.G. (128" - 028") (3.251 - 0.7109 m/ms) 13 S.W.G. (092", 2.336 m/ms) and 16 S.W.G. (064", 1.625 m/ms) are the most widely used sizes for the production of electronic equipment.

ERSIN MULTICORE

**THE SOLDER WIRE CONTAINING
3 cores OF NON-CORROSIVE ERSIN FLUX**

MULTICORE SOLDERS LTD.

SUITE 5, COMMONWEALTH HOUSE, NEW OXFORD STREET, LONDON, W.C.1, ENGLAND

Telephone: CHANCERY 5171/2.

Cables: DUSTICKON. WESTCENT, LONDON.

**U.S.A. DISTRIBUTORS:
BRITISH INDUSTRIES SALES CORPORATION
401 BROADWAY, NEW YORK, N.Y. 13**

**CANADIAN DISTRIBUTORS:
SNI-DOR RADIOELECTRIC LTD.,
455 CRAIG ST. WEST, MONTREAL**



**a harper is laughed at who plays
always on the same string..**

.... so, it has been our practice through these 50 years of mica manufacturing, to grade qualities to requirements, to adjust capacities to demands and to shape forms to assemblies. It is satisfying to enjoy the confidence of exacting technicians.



When you think of MICA think of MACALLEN

the Macallen Company

16 MACALLEN STREET - BOSTON 27

CINCAGO: 563 W. Washington Blvd. CLEVELAND: 1005 Leader Bldg.

current than the induced current, the coils will attract.

While in actual construction selsyn motors are of multi-stator winding design, for purposes of explanation one-, two-, and three-stator windings will be used.

In Fig. 4, rotors R_1 and R_2 are connected in parallel across a source of a-c. Stators S_1 and S_2 are connected in parallel. In the neutral position as shown, the coupling be-

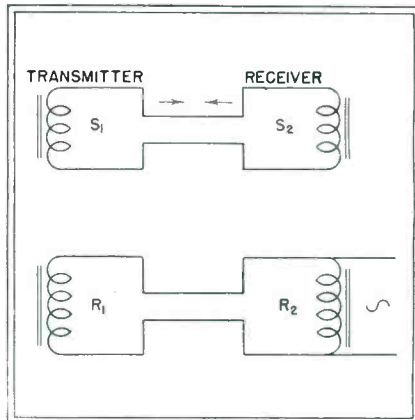

FIG. 4—When the coupling is equal, currents induced in S_1 and S_2 cancel

tween R_1-S_1 is equal to that between R_2-S_2 , hence the induced voltage across S_1 and S_2 will be equal. Since S_1 and S_2 are connected in phase opposition the induced currents will cancel, hence there is no attraction or repulsion. In Fig. 5, the transmitter rotor R_1 has been turned clockwise about 45 degrees, the coupling between S_2-R_2 is now tighter than S_1-R_1 , thus the induced voltage across S_2 is now greater than across S_1 . Current will now flow from S_2 to S_1 . This current flow is due to induced current, (R_2 to S_2), hence

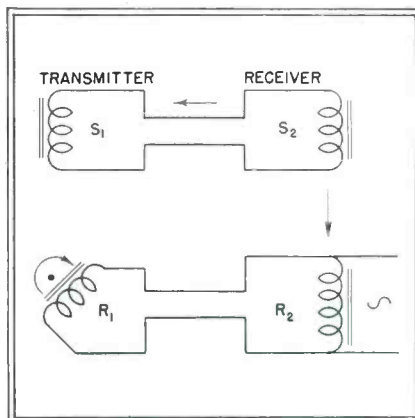

FIG. 5—Turning rotor R_1 produces a higher voltage across S_2 than across S_1



BECKMAN Helipot

Now available for
civilian electronic applications!

Can you use this important development to improve your product?

THE HELIPOT—a Beckman development widely used during the war on such precision instruments as radar, flight control units, depth sounding devices, and other critical electronic equipment—is now available to manufacturers and users of civilian electronic instruments!

The Beckman Helipot is a unique *new type* of potentiometer-rheostat which combines in *one compact unit* both the wide resistance range and extreme fineness of adjustment heretofore usually obtainable only through use of *two* separate rheostats, *two* control knobs, *two* adjusting operations. It is outstanding for all types of precision electronic equipment requiring high linearity, wide range and precise resistance control.

► **WHAT IT IS:** The Beckman Helipot consists of a long, precision slide wire coiled helically into a small case and equipped with a slider contact assembly that is moved in the usual manner—by rotation of a shaft. A simple device automatically guides the slider contact over the helical path of the resistance winding so that the entire length of the wire can be contacted by rotation of *one* knob.

This unique design enables the Helipot to occupy no more panel space than a conventional single-turn rheostat. Yet the greatly increased length of the resistance winding provides a new standard of high accuracy *and* wide resistance range in *one* unit. It means, for example, that a ten-turn Helipot has *ten* times the *fineness of adjustment* possible with a single-turn rheostat of the same range. Or conversely, for the same fineness of adjustment a ten-turn Helipot has *ten times the range*.

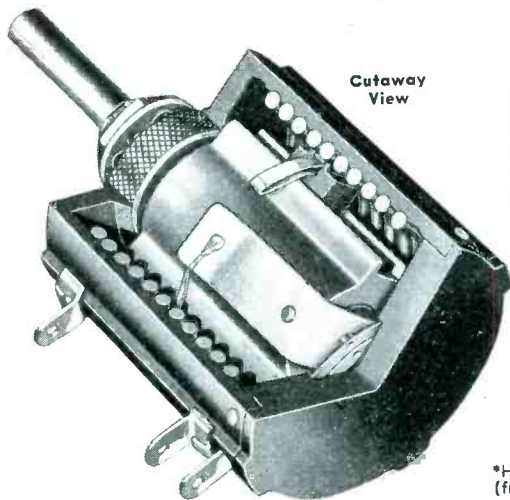

Cutaway
View

High Linearity—As a result of fulfilling wartime requirements for ultra-precision circuit controls, Helipot's are mass-produced with linearity tolerances of *one tenth of one per cent*—and even less!

Precise Settings—Because of the many-times longer slide wire, settings can be made with an accuracy impossible with single turn units.

Wide Range—By coiling a long potentiometer slide wire into a helix, the Helipot provides *many times* the range possible with a single turn unit of comparable diameter and panel space requirements.

Low Torque—Of special interest for power-driven applications—the Helipot has unusually low torque characteristics. The 1½" Helipot, for example, has a torque of only *one inch-ounce*.

IMPORTANT HELIPOT FEATURES

Write for further
details!

The Beckman Helipot is precision-built of the finest materials and is designed for use in all types of high quality electronic instruments where accuracy, sensitivity, wide range and positive operation are required. Why not investigate its use to increase the accuracy, the convenience, the efficiency of your quality electronic products? Our engineers will be glad to explain how the Helipot can fit your application. Write, briefly outlining your needs and ask for Helipot Bulletin!

*HELIPOT—T. M. Reg.
(from HELlical POTentiometer)

VARIOUS SIZES AND TYPES
Current Helipot production is in several types and sizes, including . . .

Diameter	No. of Turns	Total Length Slide Wire
1½"	Up to 10	Up to 44"
3"	Up to 40	Up to 378"
Other sizes available on special order.		

THE Helipot CORPORATION, South Pasadena 2, Calif.

ATTENUATORS

by
TECH LABS



"Midget" model is especially designed for crowded apparatus or portable equipment.



- Solid silver contacts and stainless silver alloy wiper arms.
- Rotor hub pinned to shaft prevents unauthorized tampering and keeps wiper arms in perfect adjustment.
- Can be furnished in any practical impedance and db. loss per step upon request.
- TECH LABS can furnish a unit for every purpose.
- Write for bulletin No. 431.



Manufacturers of Precision Electrical Resistance Instruments
337 CENTRAL AVE. • JERSEY CITY 7, N. J.

IDEA for DESIGNERS!



1-INCH MB METERS

**FOR THAT PORTABLE
EQUIPMENT YOU'RE PLANNING**

SPACE-SAVING AND WEIGHT-SAVING, these miniature meters provide design simplicity . . . with no sacrifice in accuracy.

Scales are sharply defined—easy to read. Accuracy is within the 2% specified in the AWS. And they're engineered and constructed to retain that calibration . . . with extremely light, sensitive moving element, Alnico No. 5 magnet, precision pivots, jewel bearings, hermetical sealing . . . and many other quality features. Shock, vibration, temperature extremes, moisture are resisted successfully.

These 1¼ oz. instruments have the requisite sensitivity for many electronic applications. And for other purposes where the measured quantity depends upon electrical variations. Available in standard DC ranges from 100 microamperes through 10 milliamperes . . . and 0-10 and 0-50 millivolts. Adapted to other ranges with standard shunts, multipliers, rectifiers.

MB also presents a 1½ oz., 1½ inch series, self-contained in all standard DC ranges, and rectifier AC voltmeters and milliammeters.

THE
**MB MANUFACTURING
COMPANY, INC.**

ELECTRICAL METERS FOR
AIRCRAFT AND PORTABLE EQUIPMENT

Instrument Division
331 EAST ST., NEW HAVEN 11, CONN.



Fungus-Proofed Waxes

As a vital service to the Armed Forces we now offer Fungus Resistant Materials. These recently developed products are the answer to Communications requirements where the impregnation or coating of radio parts and equipment are concerned.

ZOPHAR waxes and compounds meet every specification of both the Army and Navy for waterproofing and insulating all electrical and radio components. They also have wide application in packaging of every description.

ZOPHAR MILLS

112-130—26th STREET
BROOKLYN, N. Y.

ESTABLISHED 1846

Second to none



**AUDIO
TRANSFORMERS**

for

TRUE FIDELITY

DEPENDABILITY

MODERN DESIGN

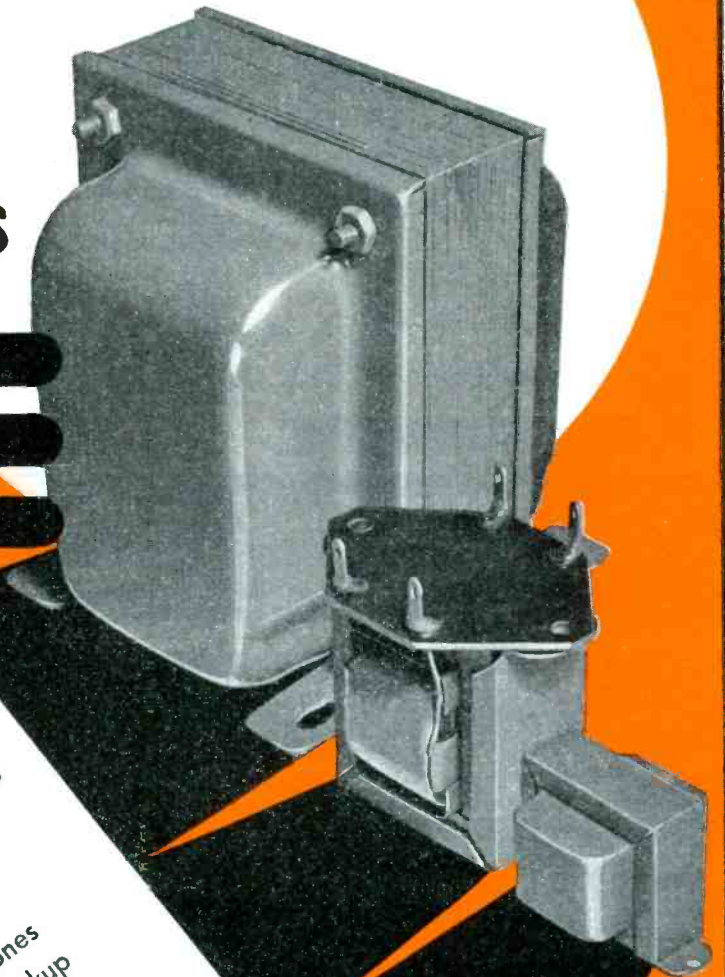

A Complete Line of
RADIO TRANSFORMERS

for

Input from Microphones
Input from phono-pickup
Input from line

Tube Coupling

Output to Voice Coils
Output to record cutters
Output to line

SEND FOR CIRCULAR E-12



INDUSTRIAL TRANSFORMER CORP.

2540 BELMONT AVENUE

NEW YORK, N. Y.

Specialists in Special Crystals



CRL 81

Write Dept. E.L. for comprehensive catalogue "Electronic Crystals" and facilities booklet "Crystalab Solves a Problem".



Nankee Ingenuity makes us

SPECIALISTS IN SPECIAL CRYSTALS

PRECISION BEAT FREQUENCY CRYSTALS

This combination of two low frequency low drift crystals operating in a balanced oscillating circuit can be paired to give any value beat note, (difference frequency). Over ordinary commercial temperature ranges 25°C to 65°C, frequency precision in the beat note of twenty parts in a million is attained. . . . greater precision with oven control.

By using high frequency crystals in the same method similar results can be obtained. Whatever your crystal problem . . . call in a Crystalab engineer.



CRYSTAL RESEARCH LABORATORIES

INCORPORATED

LABORATORIES AND MAIN OFFICE: 29 ALLYN STREET, HARTFORD 3, CONN.
New York Office: 15 E. 26th Street, New York 10, N. Y. Phone MU 5-2952

POWDERED METAL CORES

PyroFerric's

EXCLUSIVE SPECIALTY

Since 1936, we of the PyroFerric Company have devoted ourselves exclusively to the art of manufacturing powdered metal cores . . . at no time have we been affiliated with other enterprises such as radio set manufacturing, coil winding, etc.

Today our policy is the same as always; to manufacture the best of our unique type of product and to serve all of the radio business without preference or partiality.

PYROFERRIC means specification powdered metal cores.

PYROFERRIC Co.

175 VARICK ST. NEW YORK 14, N. Y.

S_2 will repel R_2 . Since S_2 is stationary and R_2 is free to move, rotor R_2 will turn until the voltages across S_1 - S_2 are equal (same degree of coupling), thus R_2 will rotate 45 degrees.

Neutral Position

Referring next to Fig. 6, rotors R_1 and R_2 are coupled with stators S_1 , S_2 , S_3 and S_4 in neutral position as shown; the degree of coupling between R_1 - S_1 and R_2 - S_2 are equal and the coupling between R_1 - S_3 and R_2 - S_4 are also equal. The degree of coupling of R_1 - S_2 and R_2 - S_1 is less

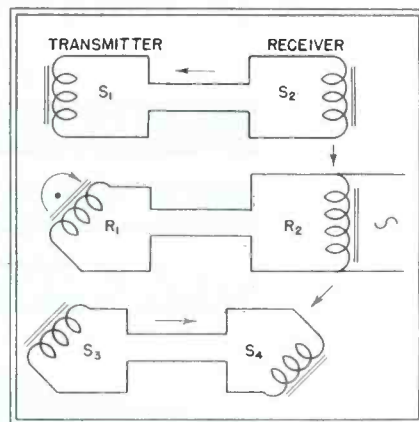

FIG. 6—If stator S_3 and S_4 are turned to the same angle, there is no movement of the rotors

than R_1 - S_1 and R_2 - S_2 , hence the induced voltages across S_3 - S_4 will be less than across S_1 - S_2 , however, in the neutral position as shown in Fig. 6, the voltages across S_3 - S_4 are equal and opposite, likewise the voltages across S_1 and S_2 are equal and opposite even though higher. Since the voltages across the respective stators cancel, no movement of rotor R_2 takes place.

In Fig. 7, transmitter rotor R_1 has been displaced 45 degrees, the coupling between R_2 - S_2 is now tighter than R_1 - S_1 , hence current will flow from S_2 to S_1 . As this current flow is due to induced current from R_2 to S_2 , stator S_2 will repel rotor R_2 . The coupling between R_1 - S_3 is tighter than the coupling R_2 - S_4 and the voltage across S_3 is greater than across S_4 . Current therefore will flow from S_3 to S_1 . The currents across the rotors are out of phase and the current from S_3 will predominate as it is of greater magnitude. Rotor R_2 will now be attracted by stator S_1 . In the position shown

“**T**

he war has sharply demonstrated that the service of railroads is indispensable and that private ownership, management and operation are able and efficient. Now that the war is over, railroad plants should be modernized to take advantage of new things learned during the war years and to permit operation under new and higher standards. Railroad radio is one of these new developments, and, as a means of communication, has already been installed experimentally at several points in yard operation and its experimental use on certain sections on our main line is planned.”

G. Metzman

President, New York Central System

Mr. Metzman's statement symbolizes the forward-looking thinking of top railway management today. The railroads *are* going forward, with improvements and modernization designed to increase the efficiency and safety of all types of operations.



The Farnsworth Television & Radio Corporation, through its recent acquisition of the Halstead Traffic Communications Corporation, is playing an increasingly important part in furthering these aims. Halstead Systems provide a factor of safety unique to the field of mobile communications. A radio counterpart of the closed-circuit principle, perfected during the war, is contained in the exclusive "auto-pulse" unit, standard

on all Halstead equipment, whether AM or FM, space or induction type systems.

The combined talent of Farnsworth and Halstead research and engineering, together with Farnsworth's productive skills and facilities will keep in step with the railroads' growing interest in mobile communications.

For specific information, write Farnsworth Television & Radio Corporation, Dept. E-12, Fort Wayne 1, Ind.

FARNSWORTH

**TELEVISION &
RADIO CORPORATION**

Farnsworth Radio and Television Receivers and Transmitters • Aircraft Radio Equipment • Farnsworth Television Tubes • Halstead Mobile Communications and Traffic Control Systems for Rail and Highway • the Farnsworth Phonograph-Radio • the Capehart • the Capehart-Panamuse

**PRECISION
CRYSTALS**

S
I
N
C
E



1
9
3
4

TYPE Z-1

**THE NEW STANDARD CRYSTAL UNIT
FOR ALL HIGH FREQUENCY SERVICE**

**FREQUENCY 1.5 TO 10.5 MC.
TEMPERATURE COEFFICIENT LESS THAN 2 CYCLES
PER MC. PER DEGREE CENTIGRADE
CALIBRATION ACCURATE TO WITHIN .005%
OF SPECIFIED FREQUENCY**

**MADE BY
PETERSEN RADIO COMPANY
COUNCIL BLUFFS, IOWA**

**THE
VIBRATION-PROOF
SHOCK-PROOF
EBY
MINIATURE
TUBE
SOCKET**



*The ideal miniature socket for
RAILWAY • AIRCRAFT
AUTOMOTIVE
and other commercial radio
and electronics equipment*

Now available for commercial use—the famous Eby miniature tube socket, the only socket meeting specification JAN-S-28 for military aircraft use.

Developed to meet the most rigorous service conditions of constant vibration and shock, the peace-time applications of this socket are readily apparent.

The use of the Eby miniature tube socket with special beryllium copper contacts assures minimum tube breakage and maximum uninterrupted operation of equipment.

Can be supplied with shock shield and protective cover or saddle type.

(Also available with phosphor bronze contacts for home radio receivers.)

Write today for Samples and Prices of the Eby Vibration-proof, shock-proof miniature tube socket.

**HUGH H.
EBY**
INCORPORATED
18 W. CHELTEN AVE.
PHILA. 44, PENNA.



**TRIGGER CONTROL
EASY HANDLING**

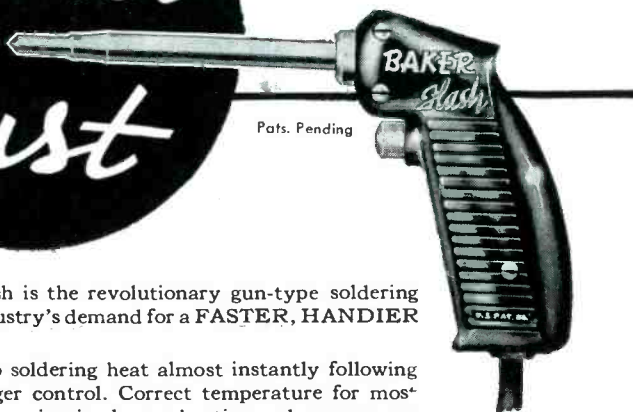

Pats. Pending

● The BAKER Flash is the revolutionary gun-type soldering iron that answers industry's demand for a FASTER, HANDIER tool.

The tip flashes to soldering heat almost instantly following pressure on the trigger control. Correct temperature for most efficient work is easily maintained, over-heating and unnecessary oxydation avoided, cleaning and re-tinning time saved.

Natural gun grip; cool, protected plastic handle; light weight; perfect balance—these are advantages that make the BAKER Flash extremely easy to use, *ideal for work in close places.*

Completely equipped for immediate operation from 110-volt transformer or from standard storage battery.

Write or Wire for Complete Information

ORDER SAMPLE TODAY—Only \$4.75 Postpaid
with Transformer \$8.95—Send check or Money Order

BAKER-PHILLIPS CO. 3057 LYNDAL AV. SO. MINNEAPOLIS 8, MINNESOTA

**THE YEAR'S
BIGGEST
NEWS IN
SOLDERING**



FROM FURNACE TO ICE BATH... *instantly*

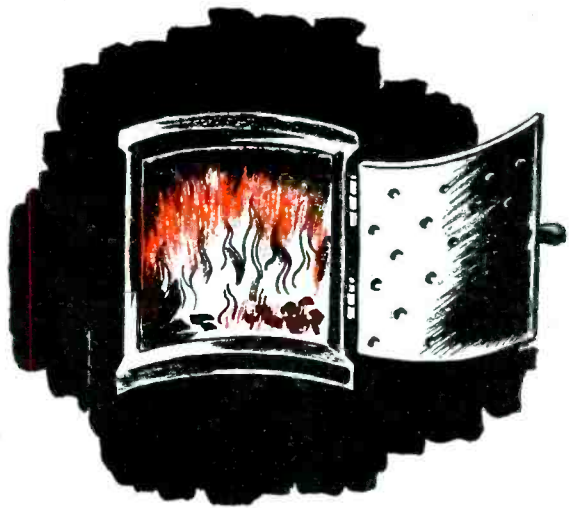

CERAMIC M-244 *does not crack*

DOES NOT CRACK! Heated to 1400° F. and then plunged instantly into ice water, Material M-244 comes through without a crack.

DIMENSIONAL STABILITY OF INVARI! The low thermal expansion coefficient of this recently developed General Ceramics product is within the same range as that of invar.

These unusual properties of M-244 suggest its use in high temperature furnaces, high frequency induction heating units, thermo-couple insulation, and as insulation in vacuum tubes . . . for scores of other uses where thermal shock is a factor . . . where dimensional changes of insulation due to heat changes must be absolutely minimized.

The adaptability of M-244 Ceramic to widely varied uses is further evident in the fact that it can be supplied in any form that may be imparted by pressing, extruding or casting.

INFORMATION AVAILABLE. General Ceramics and Steatite Corporation offers the services of its design, engineering and research staffs to help industry explore and exploit the vast potentialities of versatile M-244. Write for technical data.



Ⓜ 436

CARDWELL skill and facilities responsible for this "Special Order" Equipment are available for design and production problems...

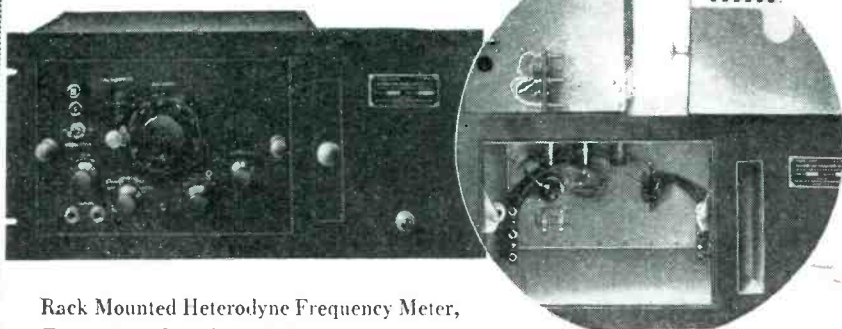

Rack Mounted Heterodyne Frequency Meter, Type 221 - Complete with A.C. power supply; ranges: 125 kc. to 20,000 kc.

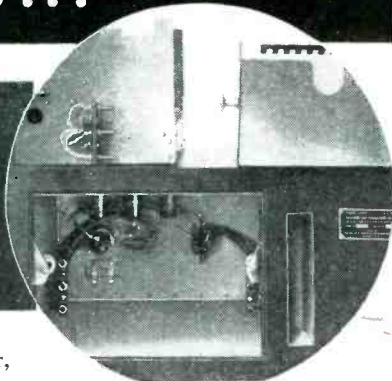

Similar Frequency Meter in Portable Case - Battery operated (or A.C. power supply can be substituted); ranges of various Army or Navy Frequency Meters:

Type 221.....	125 kc. to	20 Mc.
Type 173.....	90 Mc. to	450 Mc.
Type 174.....	20 Mc. to	250 Mc.
Type 175.....	85 Mc. to	1000 Mc.

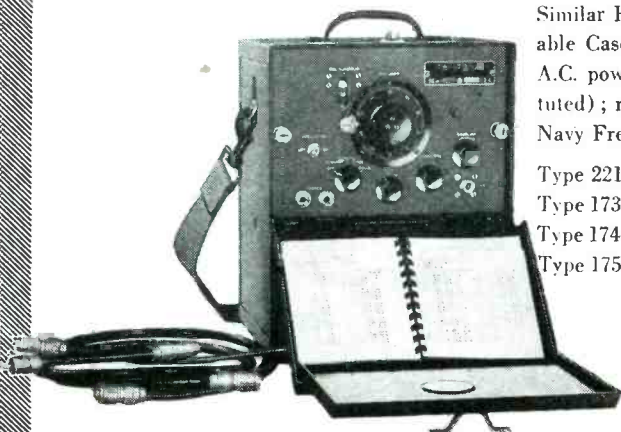

These are instruments of accuracy and precision as manufactured for government service by the makers of Cardwell variable and fixed air capacitors, which have long been a "Standard of Comparison".

The Cardwell engineering and manufacturing personnel and facilities, so skillfully employed on this equipment, are available for any production or design problem in the field of electronics.



Address inquiries to:

DEPT. E, CONTRACT MANUFACTURING DIVISION



THE ALLEN D. CARDWELL MANUFACTURING CORP.

MAIN OFFICE: 81 PROSPECT STREET, BROOKLYN 1, N. Y.

FACTORIES: PLAINVILLE, CONN. - BROOKLYN, N. Y.

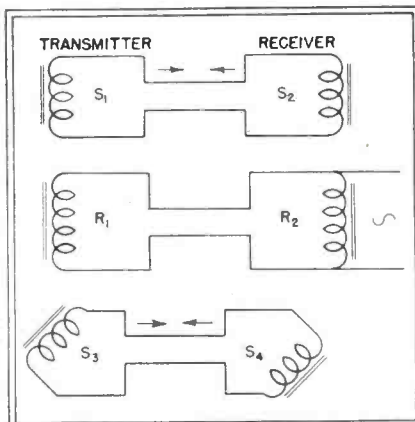

FIG. 7—Turning R_1 will cause R_2 to rotate

in Fig. 7, stator S_2 will repel rotor R_2 and stator S_1 will attract rotor R_2 since the current from S_3 has reversed the original poles of S_1 .

In Fig. 8, three stators are shown displaced 120 degrees on each motor. In actual construction, interwound multiple poles are used. The same degree of coupling exists between R_1-S_1 and R_2-S_3 , R_1-S_3 and R_2-S_6 , R_1-S_6 and R_2-S_1 . Since the voltages across the respectively connected stators are equal and opposite, the system is in neutral position.

Multiple Stators

In Fig. 9, transmitter rotor R_1 has been displaced 45 degrees by external means. Coupling between R_2-S_2 is now tighter than R_1-S_1 , thus current will flow from S_2 to S_1 because the voltage is higher across S_2 . This current flow is due to induced current R_2 to S_2 and S_2 will repel R_2 .

Coupling between R_2-S_6 is greater than R_1-S_6 , thus the voltage across S_6 is higher than across S_1 , current

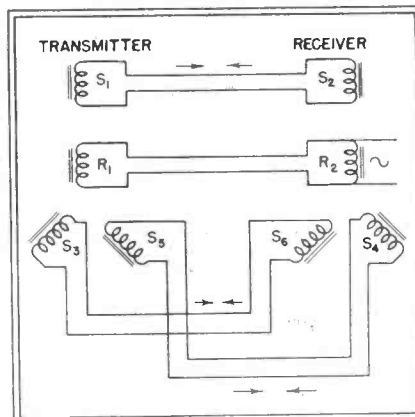
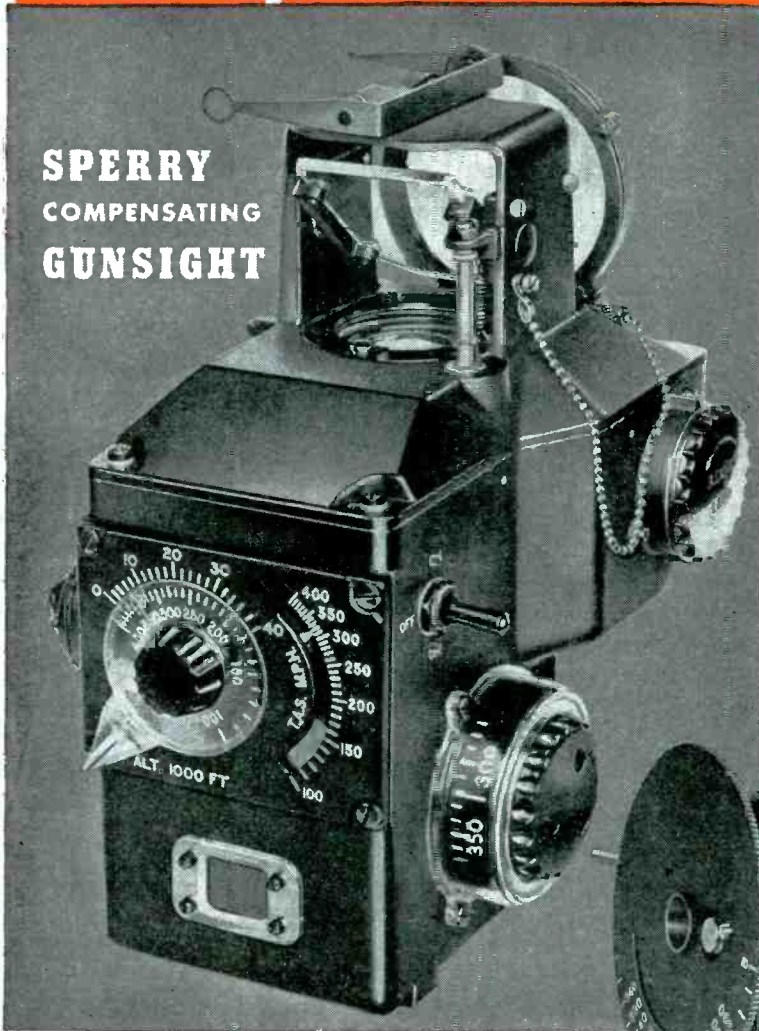

FIG. 8—Neutral position with three stators in each motor

Sperry

FOUND A BETTER WAY TO HOLD MACHINE PARTS TOGETHER WALDES TRUARC RETAINING RINGS

SPERRY
COMPENSATING
GUNSIGHT



Before using **Waldes Truarc Retaining Rings** in Sperry gunsights, Sperry Gyroscope Co. engineers had difficulty with important taper pins working loose while the gunsights were in service. Due to vibration, pins occasionally loosened and fell out affecting the accuracy of the gunsights. Frequent, thorough inspection of taper pins in use didn't entirely solve the problem.

Then they specified **Waldes Truarc Rings**. Where taper pins had previously worked loose, the rings now held them fast. Assembly of the gunsights became much easier and quicker. Because of this earlier experience, Sperry used Waldes Truarc Rings as original equipment in their K-13 Compensating Gunsights. And Truarc exceeded their highest requirement for dependability in action.

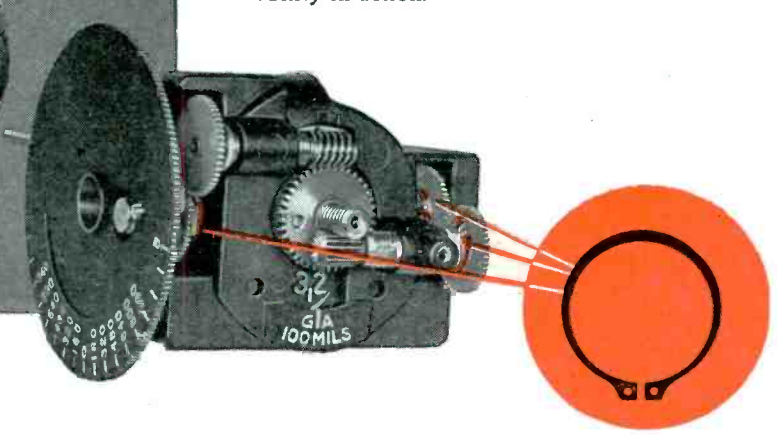

Waldes Truarc Retaining Rings are used to save weight, space, cost and man-hours in a wide range of products. For holding and positioning machine parts they offer definite advantages over nuts, shoulders, collars, and pins. They simplify and speed up production. They can be put on and taken off again and again—and still retain the perfect circularity which gives them their unyielding grip. Test them yourself. We'll furnish samples and complete data. Write Dept. H-12.

**WALDES
TRUARC
RETAINING RINGS**

WALDES KOHINOOR, INC., LONG ISLAND CITY 1, NEW YORK
CANADIAN REPRESENTATIVES: PRENCO PROGRESS CORP., LTD., 72-74 STAFFORD ST., TORONTO

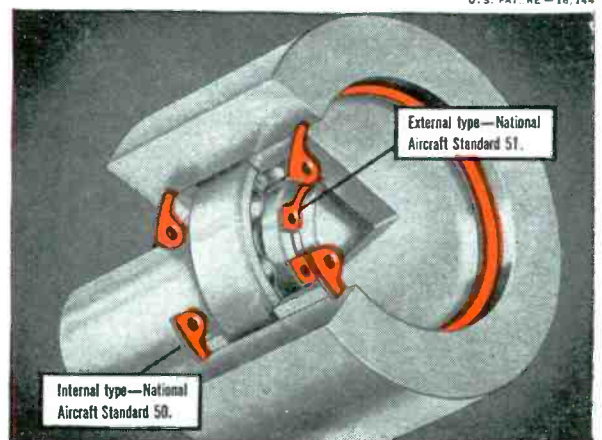

ANOTHER
SPECIAL BY
PROGRESSIVE

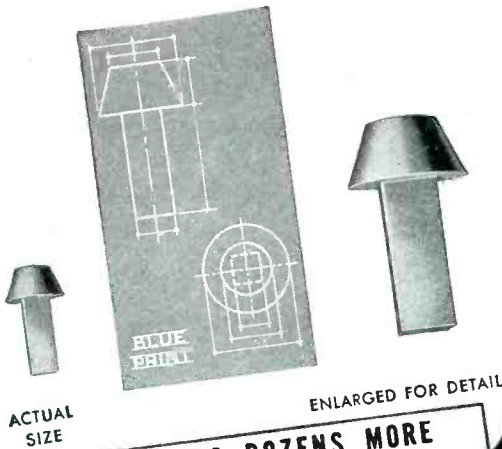

CATALOG SHOWS DOZENS MORE

Special heads, threads and finishes on any metal or alloy adapted to cold upset. Weekly output: 25,000,000 pieces. Many specials, suggesting production savings for you, illustrated in latest catalog. Includes weights per IM standard pieces, dec. equivs. of fractions, other purchasing and engineering helps. Write for Catalog 18.

The PROGRESSIVE MFG. CO.
50 NORWOOD ST. TORRINGTON, CONN.

**Little Blowers
do BIG Jobs
efficiently...quietly**

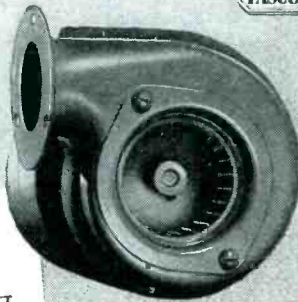

50745 BLOWER

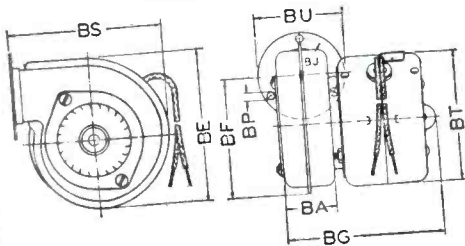

MODEL 50745

Typical applications of these small (15 to 100 C.F.M.) Blowers are air distribution in confined spaces such as: cooling radio and other electronic equipment; forced draft; exhausting fumes and gases. Write for Bulletin 3A-14 today.

DIMENSION CHART

BA	BE	BF	BG	BJ	BP	BS	BT	BU
1-5/16"	3-3/16"	3"	4"	15/16"	13/64"	3-29/32"	3-11/32"	2-1/4"

F. A. SMITH MFG. CO., INC., 801 Davis St., Rochester 2, N. Y.

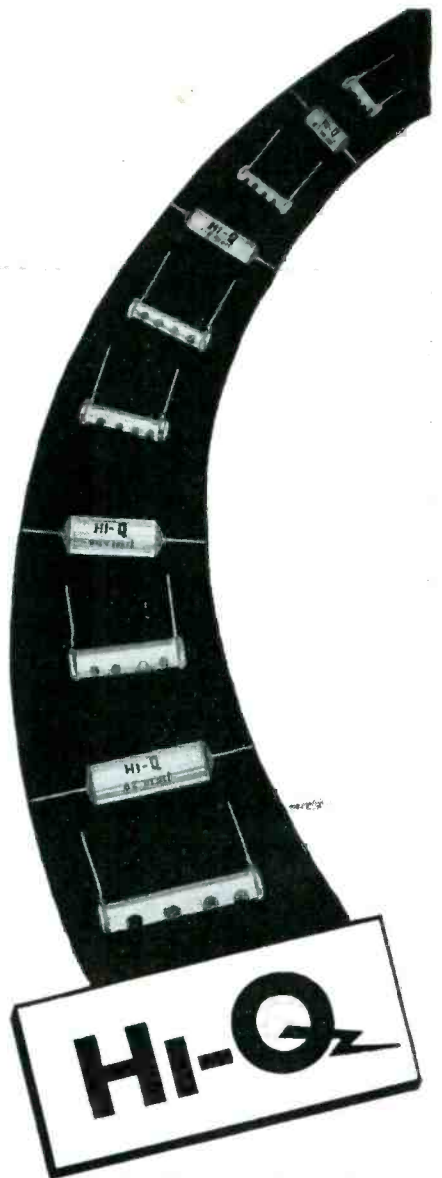

HI-Q

**CERAMIC
CAPACITORS**

● Available in Temperature Compensating and Hi-K type. Dielectric factors 19 to over 1200. Solid Silver condenser plates, non-aging and non-corrosive, gauged to thousandths of an inch, fused for long life performance.

Hi-Dielectric Enamel Finish withstands mechanical and thermal shock.

Color coded for accuracy in identification.

**ELECTRICAL
REACTANCE
CORPORATION
FRANKLINVILLE, N. Y.**

**THREE HIGH FREQUENCY
TRANSMITTING TRIODES**

ELECTRICALLY IDENTICAL

*... but with different grid
terminal locations to aid
in your equipment design!*

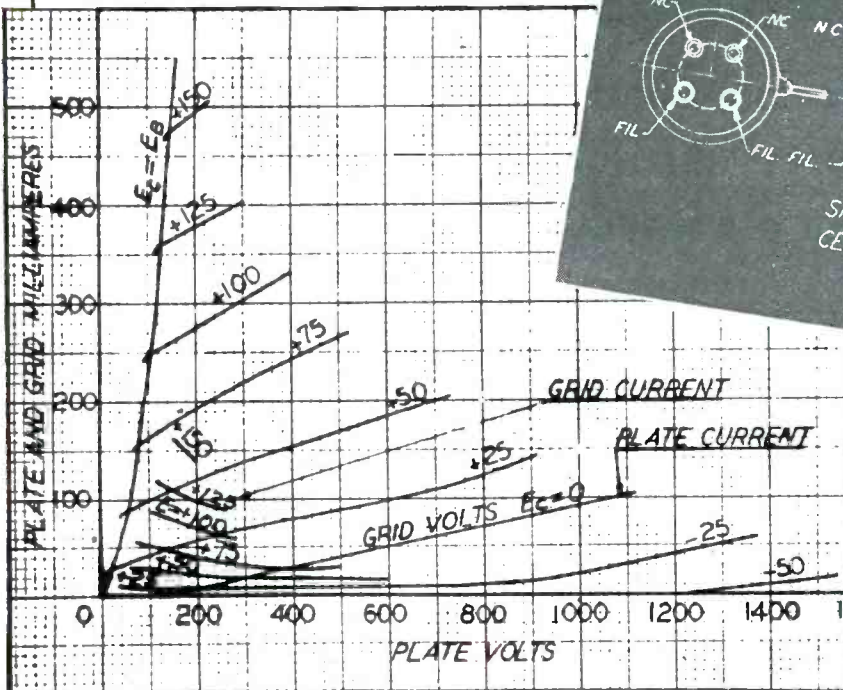
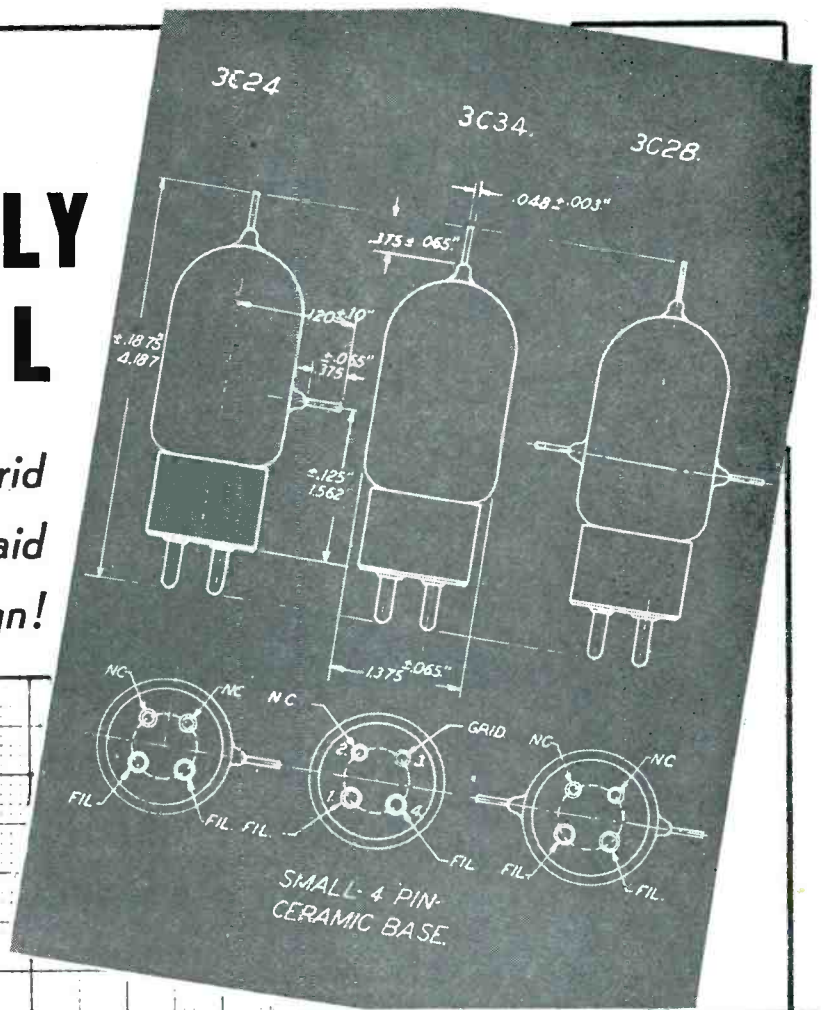

• Here, again, Lewis engineers offer wider latitude in equipment design through the development of these three electrically identical high frequency transmitting triodes . . . with different grid terminal locations. If you are interested in these, or other type tubes with special design features applicable to your equipment, write, wire or phone today.

3C24 • 3C34 • 3C28 HIGH FREQUENCY TRANSMITTING TRIODES

Filament Thoriated Tungsten
Voltage 6.3 ac or dc volts
Current 3.0 amps
Amplification factor 25

Direct Interelectrode Capacitances:

	3C24	3C34	3C28
Grid-Plate	1.6	1.7	1.8 mmfds
Grid-Filament	2.0	2.5	2.1 mmfds
Plate-Filament	0.2	0.4	0.1 mmfds

**Class "C" R-F Amplifier
Frequency Limits**

	3C24	3C34	3C28
Full power input	60	60	100 mcs
Half power input	250	200	350 mcs

Licensed under R.C.A. Patents





WALKER-TURNER FLEXIBLE SHAFTING

*Scientifically
Engineered*

Better Engineering Produces Smoother Remote Control

● Remote controls equipped with Walker-Turner Flexible Shafting have finger-touch sensitivity. There are no impulse "gaps", "slow-downs" or "jumps" . . . because each lay of wire is scientifically wound around a high grade steel music wire mandrel.

In Walker-Turner Remote Control Shafting oxidation is minimized by a special process involving a copper sulphate bath—thus insuring long, trouble-free service. Whether your products require flexible shafting for remote control, power transmission, or both, you can always count on Walker-Turner Flexible Shafting for the high quality that produces high performance. Write for our latest catalog.

WALKER-TURNER COMPANY, Inc.
• PLAINFIELD, NEW JERSEY •

will flow from S_5 to S_6 and, since this current flow is due to induced current (R_2 to S_6), stator S_5 will also repel rotor R_2 . Coupling between rotor R_1 and stator S_3 is tighter than R_2 - S_5 , hence the voltage across S_3 is higher than across S_5 . Current will therefore flow from S_3 to

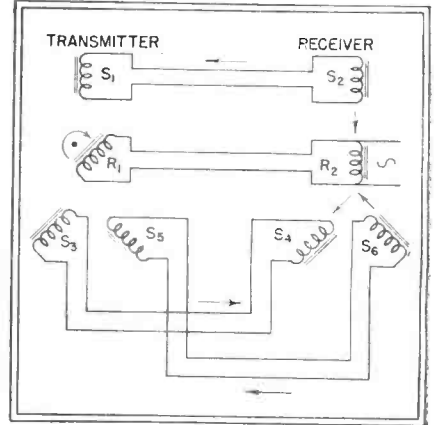

FIG. 9—Stators S_2 and S_6 repel rotor R_2 ; stator S_3 attracts R_2 .

S_4 . Since the currents are out of phase, the largest will predominate and current from S_3 will reverse the poles on S_3 ; therefore coil S_3 will attract rotor R_2 . Rotor R_2 will rotate 45 degrees and the voltages across the respectively connected stator coils will again be equalized; the induced currents will cancel returning the system to a neutral position with equal voltages across connected stator coils.

In Fig. 10, the transmitter and

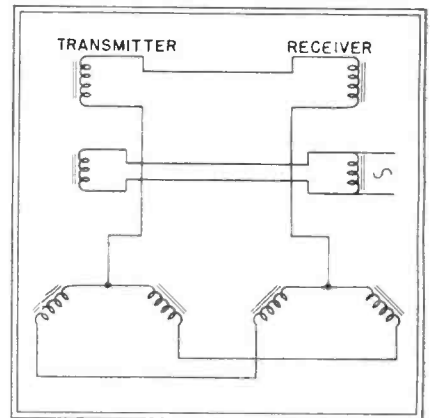

FIG. 10—Wye connection of coils equivalent to Fig 9

receiver coils are shown in wye connection which is electrically equivalent to Fig. 9. The reader should have no trouble solving the rotation of the receiver rotor through 360 degrees of rotation.



FLEXIBLE SHAFTING
FOR REMOTE CONTROL AND POWER TRANSMISSION

DESIGNED AND ENGINEERED AT NO. 1 PLASTICS AVENUE

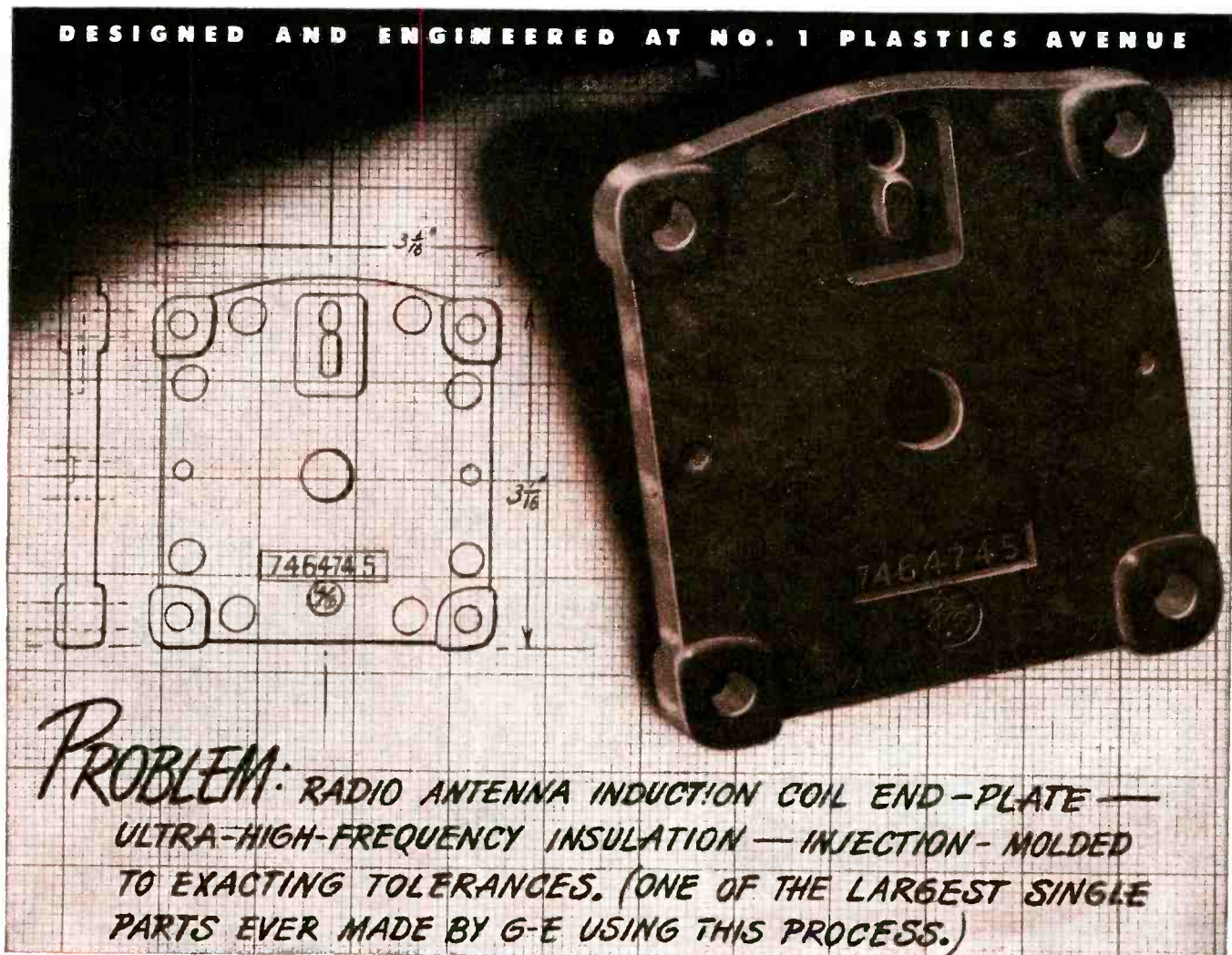

PROBLEM: RADIO ANTENNA INDUCTION COIL END-PLATE —
ULTRA-HIGH-FREQUENCY INSULATION — INJECTION-MOLDED
TO EXACTING TOLERANCES. (ONE OF THE LARGEST SINGLE
PARTS EVER MADE BY G-E USING THIS PROCESS.)

A LARGE INJECTION-MOLDING OF G-E MYCALEX

● This is the end-plate of a radio antenna induction coil.

It is a large electrical component that has been injection-molded by G.E.'s complete plastics service from G-E mycalex—compound of glass and powdered mica with a unique combination of properties.

And it meets not only ultra-high-frequency insulation requirements, but exacting tolerances. Rejects of this part have been reduced to a negligible percentage by specifying G-E mycalex and injection-molding.

This success suggests wider future use of G-E mycalex, which is available to you in standard sheets and rods—or molded to your design. For information, write to Section S-5, Plastics Divisions, General Electric Company, 1 Plastics Avenue, Pittsfield, Mass.



G-E MYCALEX

A Unique Combination of Properties

1. High dielectric strength
2. Low power factor
3. Prolonged resistance to electrical arcs
4. Chemical stability—no deterioration with age
5. Dimensional stability—freedom from warpage and shrinkage
6. Imperviousness to water, oil, and gas
7. Resistance to sudden temperature changes
8. Low coefficient of thermal expansion
9. High heat resistance

Samples Supplied on Request

GENERAL  ELECTRIC

CD46-M6

LET US QUOTE ON YOUR

SMALL STAMPINGS

SPECIAL TERMINALS

SOLDERING LUGS

PRECISION WASHERS up to 5/8" O. D.

Manufactured to Your Specifications

Large Tool Room Facilities plus 20 Years Experience insure

**HIGH GRADE STAMPINGS
QUICK DELIVERIES**

on Medium and Large Quantities

Let Us Quote on Your Requirements

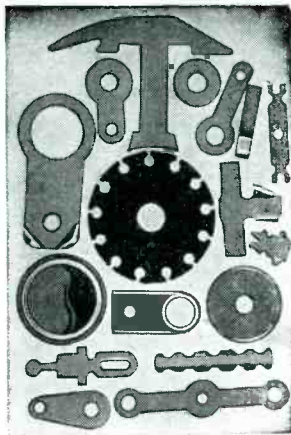

DIEBEL DIE & MFG. CO.

3658 N. Lincoln Ave., Chicago 13, Ill. Phone WELLington 4202



UP TO 3.2 K.V.A.

D.C. to A.C. CONVERTERS

An Inverted Rotary Converter is a rotating electrical machine for converting direct to alternating current.

Janette was one of the first manufacturers to design, build and develop rotary converters for use with numerous A.C. devices; especially those using electronic tubes. Since their inception they have established a world wide record for reliable, efficient, quiet, trouble-free operation under the most adverse conditions. **Two types are built:** one for standard and special commercial uses; the other for marine service.

Ask for Bulletin 13-25 for COMMERCIAL Type Converters or Bulletin 13-27 for the MARINE Type



Janette

Janette Manufacturing Co. 556 W. Monroe St. Chicago 6, Ill.

NUMBER ONE OF

A SERIES

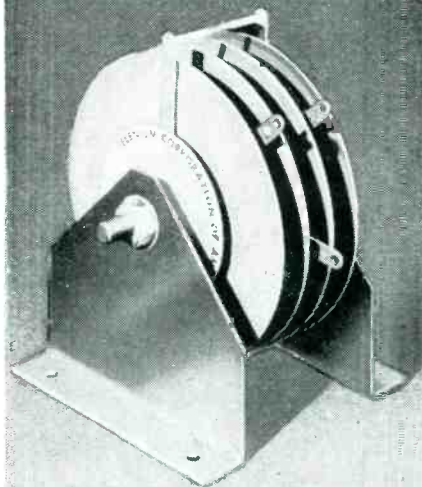

DC means SC . . . Selenium Control and Selenium Conversion for the practical, profitable performance planned by top flight design engineers. Selenium provides maximum efficiency . . . unlimited life . . . negative temperature coefficient . . . and other characteristics necessary to solve the electronic problems of tomorrow . . . That's why DC means SC.

SEND FOR BULLETIN

SELENIUM CORPORATION of AMERICA



1719 WEST PICO BOULEVARD
LOS ANGELES 15, CALIFORNIA

EXPORT DIVISION: FRAZAR & HANSEN
301 CLAY STREET, SAN FRANCISCO, CALIF. 94104

IN CANADA: BURLIC LTD., TORONTO 13, ONTARIO, CANADA

New-Sensational, RADIART MIDGET VIBRATOR has Many Applications!

TYPICAL INSTALLATION SHOWS
POSSIBLE USES



ACTUAL
SIZE

RADIART DEVELOPED THIS VIBRATOR
OPERATED POWER SUPPLY, INCLUDING
STORAGE BATTERY, FOR LIMITED
SPACE

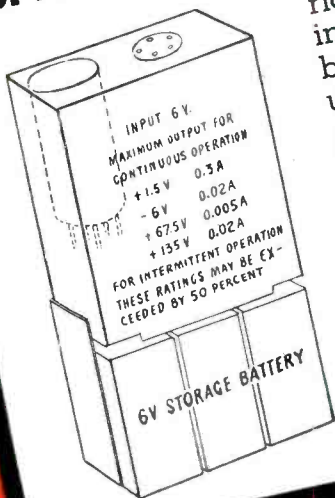

Overall dimensions of unit were
rigidly fixed at 6½" x 3½" x 1¾"—
including a rechargeable storage
battery as well as the power supply
unit.

Obviously a standard size vibrator
could not be used—so RADIART de-
veloped the VR-2 Midget Vibrator
for the job.

Check the vibrator specifications
given below as well as operating
data on the illustration of the power
supply for details.

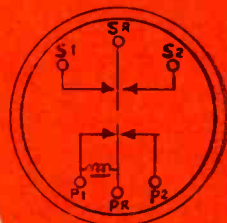

P- PRIMARY
S- SECONDARY
R- REED

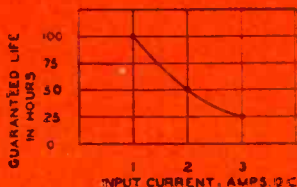

SPECIFICATIONS

- Vibrator Frequency . 185 CPS ± 10%
- Input Voltage, Nominal 6.0 V.
- Input Voltage Range . . . 4.5 to 7.5 V.
- Output Voltage . . . 200 V D.C. Max.
- Potential Difference
Between P_R & S_R 25 V. Max.

The RADIART VR-2 Midget Vibrator can now
be produced for civilian applications. Will this
be of help in your product? Send us full infor-
mation as to your requirements...our engineer-
ing department will fully cooperate.

Manufactured by makers of famous RADIART Rust Proof Aerials.



Radiart Corporation

3571 W. 62nd STREET • CLEVELAND 2, OHIO
Export Division
25 Warren St., New York 7, N.Y.
Canadian Office
455 Craig St., W., Montreal, Canada

TUBES AT WORK

Army Target Plane Controlled by Radio Transmitter.....	300
Microwave Radio Relay to Replace Telegraph Lines.....	300
Tube for SCR 270 Radar.....	308
Drafting Aids to Relay Profiling.....	316
Measurement Applications of the Dynatron.....	320

Army Target Plane Controlled by Radio Transmitter

RADIO-CONTROLLED pilotless planes have been used by the Army as targets for aerial gunnery practice by B-29 gunners and also for anti-aircraft practice by ground forces.

The plane is controlled from the ground by a uhf transmitter that is modulated by five different audio frequencies. These tones are selected by a small control box at the transmitter which is equipped with a projecting lever to simulate the joy stick of a plane. Two of the a-f signals provide rudder control and two provide elevator control. The fifth frequency centers the rudder and releases a parachute when desired by the control operator. Only one frequency is used at a time

control the elevators and rudder. The elevator and rudder servo controls remain in effect after the engine stops and the parachute is released, providing the receiver has not been damaged, so that dead-stick landings may be made in the event the parachute attachments are shot away.

Two models of the remotely controlled planes are standard equipment for the Army Air Forces. One model, the OQ-3, is a high-wing monoplane, 9 feet long, having a wing span of 12 feet 3 inches. The plane is constructed of welded steel tubing covered with airplane cloth and weighs 100 pounds. It flies at 103 miles an hour and is powered

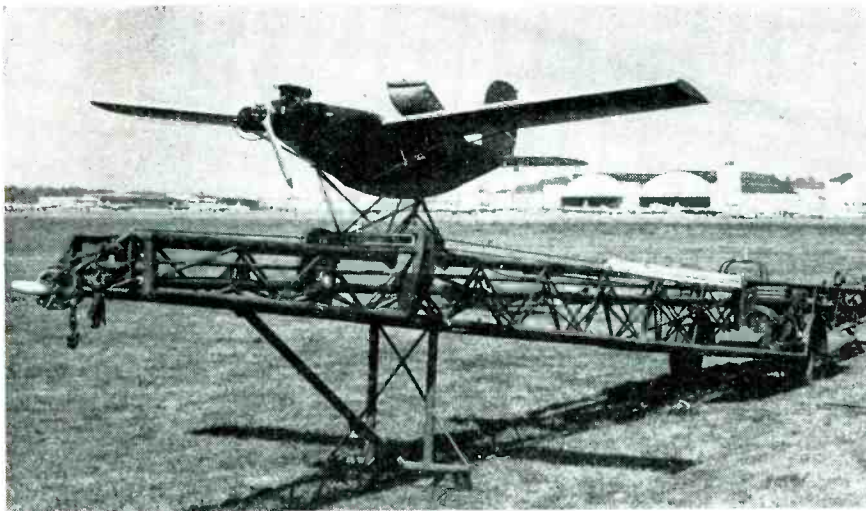

Radio-controlled target airplane model OQ-14 on its launching catapult. It provides realism for student gunners by simulating flight attitudes, dives and evasive action in response to modulated signals from a transmitter on the ground

and when none is being transmitted the parachute release frequency is automatically switched on.

Servo System

In the plane, a radio receiver and a selector circuit translate the signals and actuate a servo unit to provide mechanical action to con-

trol the elevators and rudder. The elevator and rudder servo controls remain in effect after the engine stops and the parachute is released, providing the receiver has not been damaged, so that dead-stick landings may be made in the event the parachute attachments are shot away.

A later model, the OQ-14, is powered by a 22-horsepower engine, flies 140 miles per hour and has a wing span of 11 feet, 6 inches. The planes are launched from a catapult driven by compressed spring coils or rubber cords. They fly at alti-

tudes up to 3000 feet normally.

Another use for the plane was found recently, that of a training aid for students of radar in tracking flying objects in the air for gunnery practice. In addition, the Navy is using the target airplane in its training for automatic weapons target practice.

The first models developed had a telephone dial on the control unit, used a 3-hp engine with counter-rotating props to counteract torque, and had a tricycle landing gear. These features were eliminated in the experimental stages.

The target planes are the result of eight years of research work by Lt. Col. C. O. French, Jr. and his staff at Air Technical Service Command Headquarters, Wright Field, Dayton, Ohio. They are manufactured by Radioplane Co., Van Nuys, Calif. and Globe Corporation, Joliet, Ill.

Microwave Radio Relay to Replace Telegraph Lines

MICROWAVE radio relay systems with towers about 30 miles apart between the major cities of the United States will be installed during the next seven years by Western Union Telegraph Company. No lines will be removed from the present 2,300,000-mile telegraph network until the radio system along the route has proved satisfactory, government approval is obtained and existing contracts permit.

A test circuit was installed between New York and Camden, N. J. early this year by engineers of Radio Corporation of America who developed the system. Since March, this circuit has been used by Western Union on an experimental basis between their New York and Philadelphia offices.

Multiple Antennas

The illustration shows the 100-ft tower and two of the antennas at one of two intermediate relay stations used between New York and Philadelphia. These are located near Bordentown, N. J. and at 10-Mile Run near New Brunswick, N. J. The stations are unattended and operate automatically.

On top of each tower is an 8-ft

wherever a tube is used...

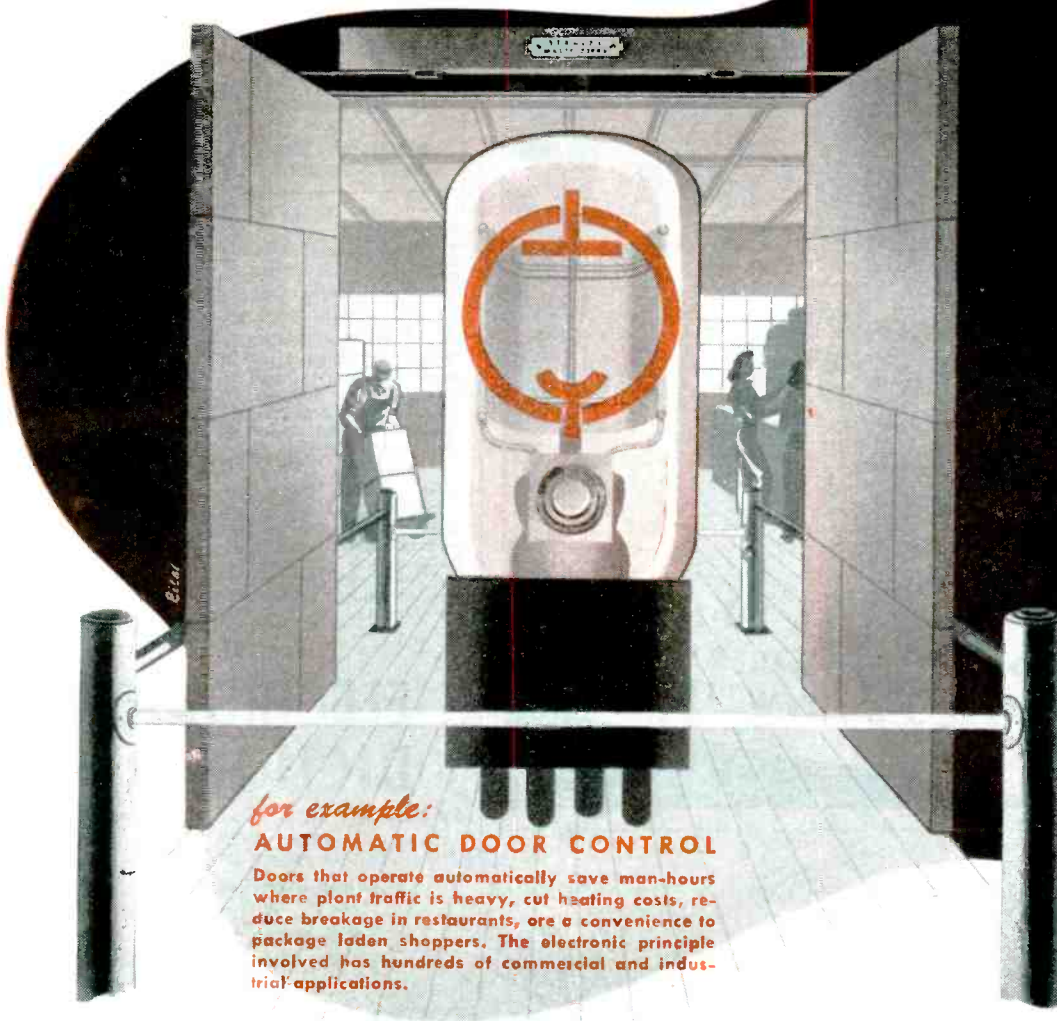

for example:
AUTOMATIC DOOR CONTROL
 Doors that operate automatically save man-hours where plant traffic is heavy, cut heating costs, reduce breakage in restaurants, are a convenience to package laden shoppers. The electronic principle involved has hundreds of commercial and industrial applications.

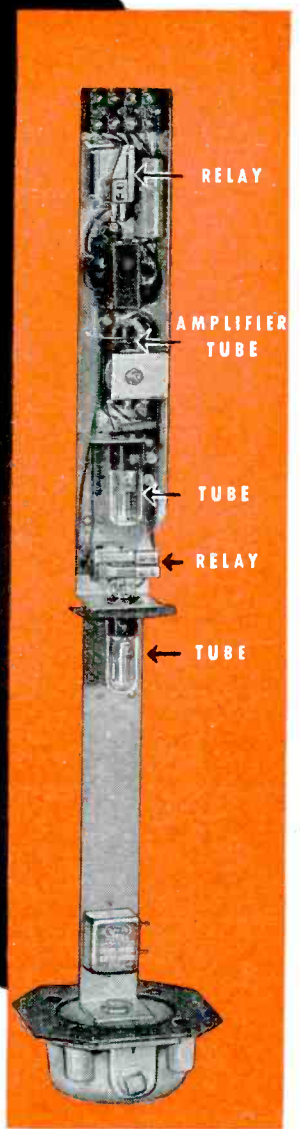

PHOTO-ELECTRIC DOOR CONTROL
 Above unit manufactured by General Electric Co., is a part of STANLEY "MAGIC DOOR" CONTROLS.

THERE'S A JOB FOR

Relays BY GUARDIAN

★ The "Magic Door" made by The Stanley Works of New Britain, Conn., uses a General Electric control unit which operates automatically at the approach of a pedestrian or vehicle. In this unit a beam of light focused on the cathode of a phototube causes a tiny current to flow. Enlarged through an amplifier tube this current operates a sensitive telephone type of relay such as the Guardian Series 405. Another phototube with an auxiliary relay, Guardian Series R-100, is employed to hold the doors open for anyone standing within the doorway.

The telephone type of relay is extremely sensitive and able to operate on the small current supplied through the electronic circuit. The auxiliary relay, Series R-100, is required to handle a greater current. It is a small, efficient relay having a contact capacity up to 1 KW at frequencies up to and including 28 megacycles. Contact combinations range up to double pole, double throw. Standard coils operate on 110 volts, 60 cycles, and draw approximately 7 V. A. Coils for other voltages are available. For further information write for Bulletin R-6.

Consult Guardian whenever a tube is used—however—Relays by Guardian are NOT limited to tube applications but are used wherever automatic control is desired for making, breaking, or changing the characteristics of electrical circuits.



Series 405 Telephone Type Relay

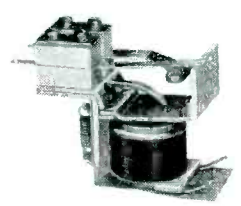

Series R-100 H. F. Relay

GUARDIAN  **ELECTRIC**
 1625-P W. WALNUT STREET CHICAGO 12, ILLINOIS
 A COMPLETE LINE OF RELAYS SERVING AMERICAN WAR INDUSTRY

PURE SILVER FOIL

Available Now

GOLD PLATED SILVER FOIL

.0005" to .003" thickness
± .00005"

▶ TECHNICAL QUALITIES
▶ UNIFORM THICKNESS
▶ FREE OF HOLES
▶ NO POROSITY

Write, Wire, or Telephone

PEERLESS ROLL LEAF CO., INC.
4517-4519 New York Avenue
UNION CITY • NEW JERSEY
Union 3-8686

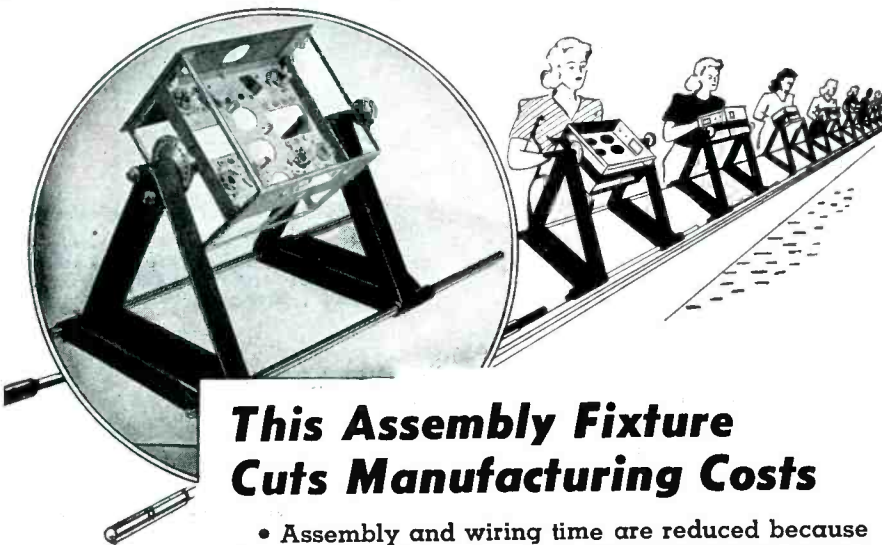

This Assembly Fixture Cuts Manufacturing Costs

- Assembly and wiring time are reduced because the position of the chassis is instantly adjustable for each operation.
- Operators do better work with less fatigue, thereby minimizing costly trouble shooting.
- One fixture investment serves for all models since each fixture is adjustable to various chassis sizes.

Send for new bulletin illustrating the standard sizes available for prompt delivery.

ROBERT L. STEDMAN MACHINE WORKS
SPECIALISTS IN MASS PRODUCTION TOOLS
OYSTER BAY, LONG ISLAND NEW YORK

Now available—
Your guide to precise usage in working with **ELECTRONICS** terms

6500
CLEAR-CUT DEFINITIONS AND REFERENCE DATA

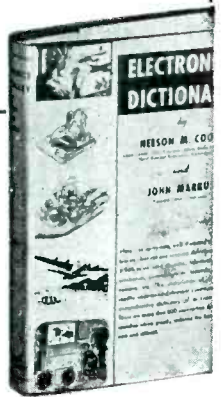

HERE is the book that every electronics and radio man has been looking for—an up-to-date, comprehensive dictionary covering all the terms used in electronics and its extensive practical applications, radio, television, communications, and industrial electronics.

For clear, precise definitions, accurate usage, well-illustrated descriptions, and for standardized spelling, abbreviating, and hyphenating policy, this book will be a constant aid to everyone working with electronics and radio engineering—whether student or engineer, editor, or engineering secretary.

Just Out!

ELECTRONICS DICTIONARY

By **NELSON M. COOKE, Lt. Com. U.S.N.**
*Executive Officer, Radio Materiel School
Naval Research Laboratory, Washington, D. C.*

and **JOHN MARKUS**
Associate Editor, *Electronics*

433 pages, 5 3/4 x 8 3/4
over 600 illustrations, \$5.00

NOW at last here is an authoritative work to clarify and define the myriad new terms that have come into usage with the vast growth of electronics and electrical engineering. Nowhere else will you find a dictionary comparable to this in scope and timeliness. Nowhere else will you find such a thorough, extensive, generously illustrated compilation.

This glossary fully covers terminology, principles, processes, equipment, abbreviations, and colloquialisms in

Radio
Television
Facsimile
Sound recording
Communications
Medical electronics
Electronic heating
Electronic welding

Photoelectric controls,
safety devices, and
intrusion detectors
Industrial electronics
Electronic motor control
Long-distance telegraph and telephone

This excellent dictionary should be of constant usefulness both to the technician and to the most advanced electronics engineer, for its definitions are exceptionally precise and accurate, and in most cases, each is complete in itself. Invaluable for its consistent abbreviating and hyphenating policy.

Send for a free-examination copy

McGraw-Hill Book Co.,
330 W. 42 St., N. Y. 18

Send me Cooke and Markus' **ELECTRONICS DICTIONARY** for 10 days' examination, on approval. In 10 days I will send \$5.00, plus few cents postage, or return book postpaid. (Postage paid on cash orders.)

Name
Address
City and State
Company
Position L. 12-45

In Canada: Mail to Embassy Book Co.
12 Richmond St E, Toronto 1

WE ARE PLEASED TO ANNOUNCE

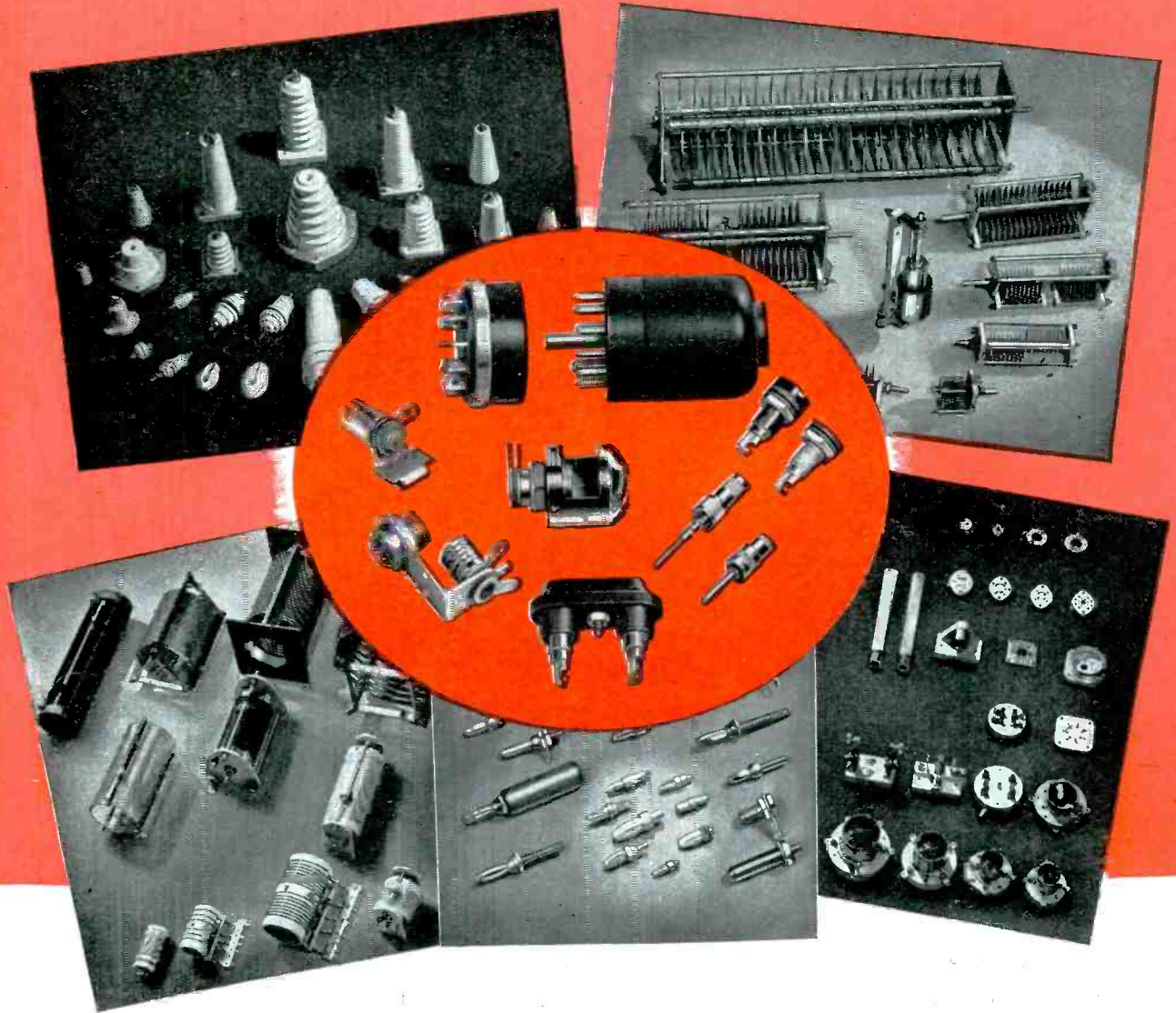

We are pleased to announce that the cable connectors, pilot light assemblies, tip plugs and tip jacks, former Mallory-Yaxley products, so highly regarded by the electronic industry for many years, will be manufactured and sold in the future solely by Johnson.

The wide acceptance and unquestioned quality of these products make them fitting additions to the Johnson line of plugs, jacks,

inductors, insulators, variable condensers and tube sockets.

All tools, inventory and manufacturing rights for these products have been acquired from P. R. Mallory & Company, Inc. Orders should specify the Mallory catalog numbers until these items can be incorporated in the Johnson catalog.

Write us, if you have a special problem involving any of these items.

Johnson products are stocked by leading radio-electronic parts jobbers.

Write for General Products Catalog 968

E. F. JOHNSON COMPANY • WASECA • MINNESOTA

JOHNSON

a famous name in Radio



Flexibility of Design
and
Compactness

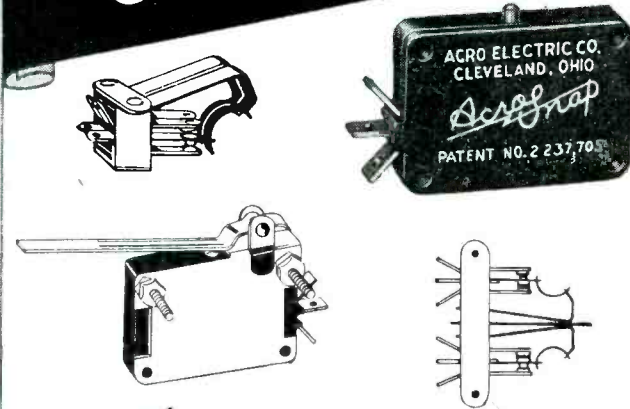

with

★ ★ Acro Switches ★ ★

• The illustrations above show in part how the construction of the patented ACRO rolling spring switch lends itself to adaptation in various shapes to fit the designs of your units. Varied multiple mountings and small case shapes—rectangular or curved—can be furnished. Operating characteristics in a range to meet your requirements. Actuation pressure as low as 2 grams (using leaf bracket) or as high as 1 ¼ lbs. Used in a wide range of applications such as valve controls, coin-operated machines, microphones, electric timers, etc. If one of the many ACRO Model "M" designs does not fit your needs, surely one of the other ACRO styles can be adapted. Send your design details showing special limitations and operating features for quicker reply.

THE ACRO ELECTRIC COMPANY

1316 SUPERIOR AVENUE • CLEVELAND 14, OHIO

square enclosed cabin. Outside the cabin four antennas are mounted in parabolic reflectors. One antenna on the east side of the tower feeds the East-to-West receiver; the other is supplied by the West-to-East transmitter. Two other antennas on the West side of the tower are

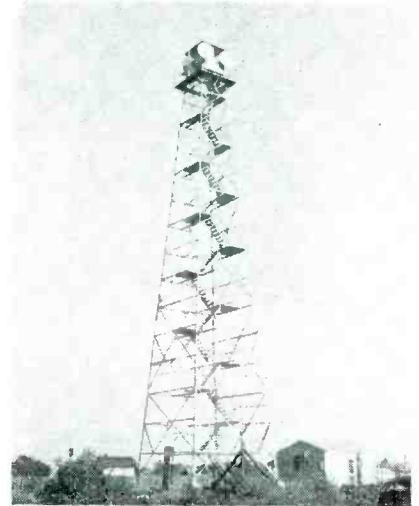

Four parabolic antennas and a cabin enclosing the transmitting and receiving equipment are mounted atop a 100-foot tower for use in the Western Union radio relay system

used on the West-to-East receiver and the East-to-West transmitter. The transmitters, receivers, demodulators and modulators are housed in the cabin.

The transmitters in the present system put out about one-tenth of a watt. However, the antennas have a power gain of 900 (so that the equivalent non-directive power is 81 kilowatts). This provides a transmitter-antenna to receiver-antenna gain of 810,000. Operation is being conducted on a frequency near 4,000 megacycles with a useful bandwidth of 150 kilocycles. It has been estimated that this is sufficient for 270 multiplex or 1080 single telegraph circuits. It could probably handle at least 25 ordinary telephone circuits, or if used for high-quality f-m broadcast service possibly eight channels. The present bandwidth is insufficient for television, but new equipment of higher power may be available soon to provide the necessary 6-mc television bandwidth.

As now used, the system provides

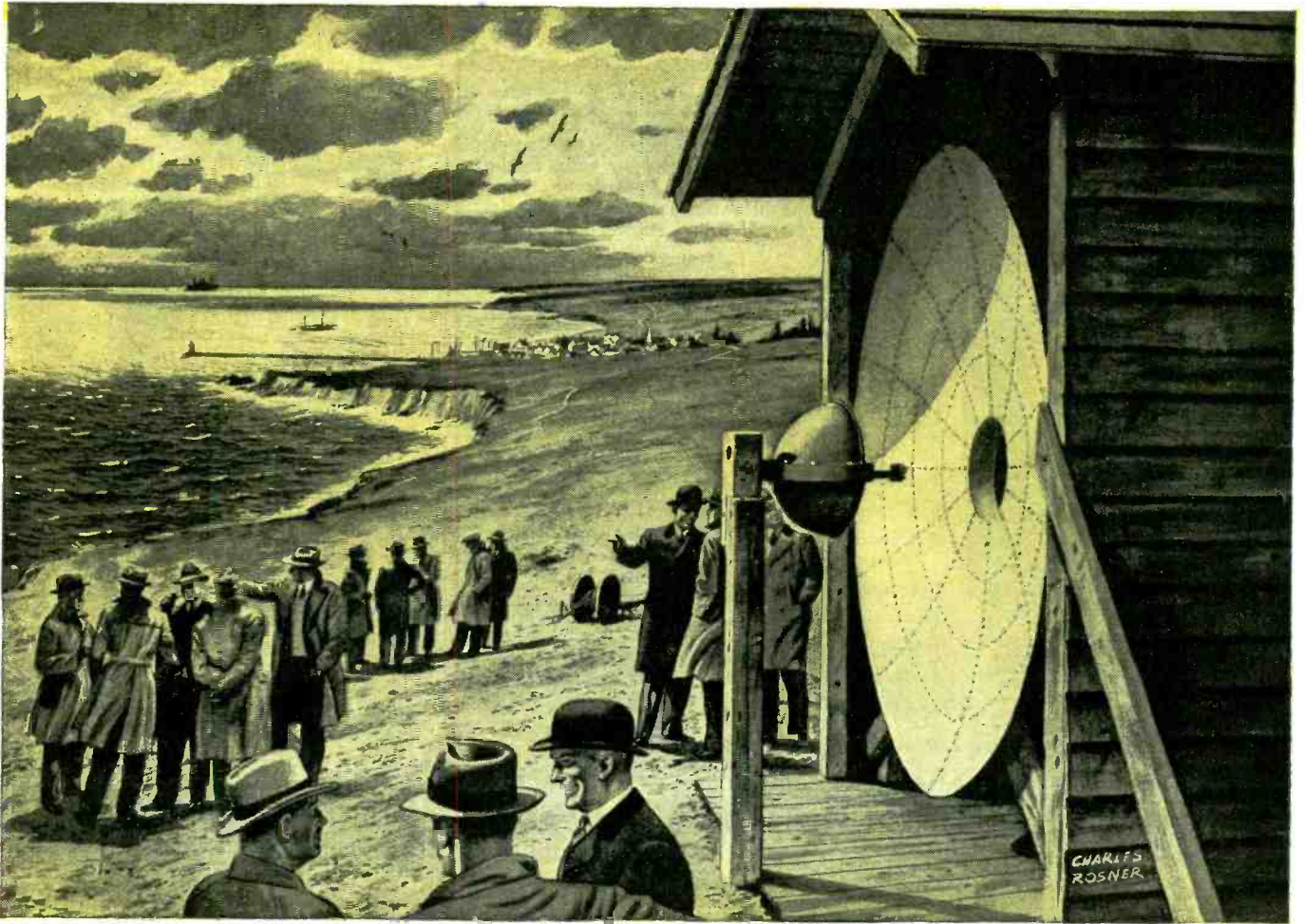

Federal's men know *Microwave*



On a gusty March day in 1931 . . . when man's voice was beamed across the English Channel from an antenna less than an inch long and powered by a mere half-watt . . . Microwave was born.

This was the inauguration of a new technique in the art of communication . . . blazing the trail for modern, high fidelity television, FM transmission, pulse time modulation, plurality of currents on a common carrier, and certain other commercial applications for this technique.

Many of the scientists now at work in Federal laboratories participated in that triumph and helped in its development through the years. Now they are engaged in extending its application, opening vast and striking possibilities for the future of communications.

Pioneer in the field of microwave . . . a contributor to radio progress for more than 35 years . . . Federal stands for leadership in research, development and manufacture of equipment and components for every segment of the communications industry.

Federal Telephone and Radio Corporation



Newark 1, N. J.

JUST PUBLISHED!

The Most Indispensable Reference in Radio-Electronics!

Electronic Engineering Master Index

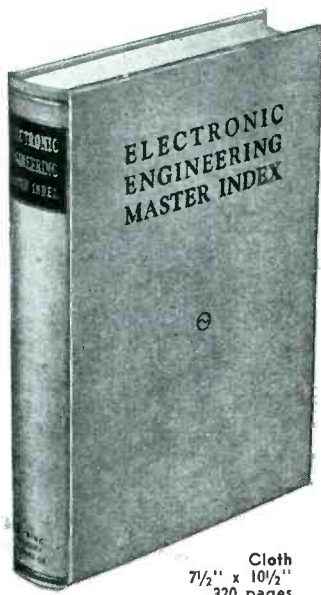

Cloth
7 1/2" x 10 1/2"
320 pages

A master compilation of over 20,000 titles, articles and texts selected for their value to the research engineer, this INDEX covers the years 1925-1945 and enables you to survey twenty years of research literature on any subject in a matter of minutes!

Vitally Needed in Every Laboratory and Library

COMPLETE IN ONE VOLUME

PART I

January 1925 to
December 1934

PART II

January 1935 to
June 1945



PARTIAL LIST OF PERIODICALS INDEXED:

- | | |
|-------------------------------|--------------------------|
| Bell Laboratories Record | Journal of I.E.E. |
| Bell System Technical Journal | General Electric Review |
| Communications | Physical Review |
| Electrical Communication | Proceedings I.R.E. |
| Electronics | Transactions of A.I.E.E. |
| Electronic Engineering | Radio News |
| Electronic Industries | R.C.A. Review |
| | Wireless Engineer |
| | Wireless World |

A \$500 Reference Library in One Volume for \$17.50

Descriptive circular on request.

ELECTRONICS RESEARCH PUBLISHING COMPANY

238 East 44th Street

New York 17, N. Y.

ARGON HELIUM KRYPTON
NEON XENON MIXTURES

Linde

RARE GASES
AND MIXTURES

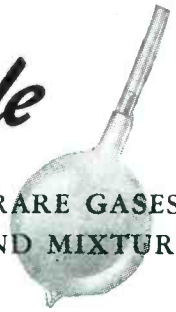

... Spectroscopically Pure
... Easily removed from bulb
without contamination

Scientific uses for LINDE rare gases include—

1. The study of electrical discharges.
2. Work with rectifying and stroboscopic devices.
3. Metallurgical research.
4. Work with inert atmospheres, where heat conduction must be increased or decreased.

Many standard mixtures are available. Special mixtures for experimental purposes can be supplied upon request.

The word "Linde" is a trade-mark of

THE LINDE AIR PRODUCTS COMPANY
Unit of Union Carbide and Carbon Corporation
30 E. 42nd St., New York 17 Offices in Principal Cities
In Canada: Dominion Oxygen Company, Ltd., Toronto

IT'S NEW! IT'S POST-WAR SUPREME Model 565 VACUUM TUBE VOLTMETER

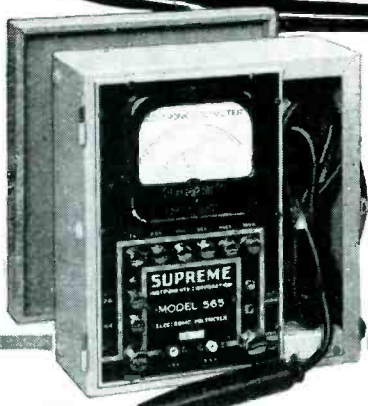

NEW PROBE Streamlined
Hand Fitting Incorporating
new High Frequency Diode

RANGES:
DC 0-1, 2.5, 10, 50, 250, 500
AC 0-1, 2.5, 10, 50, 250
EXTENDED TO 5000 VOLTS BY EXTERNAL MULTIPLIERS

FREQUENCY RANGE
Negligible frequency error from
50 cycles to 100 megacycles.

INPUT RESISTANCE.
DC—80 megohms on 1 volt range; 40 megohms on 500 volt range
AC—40 megohms on 1 volt range; 20 megohms on 250 volt range

INPUT CAPACITY OF PROBE: 5 micro-micro farads

SUPREME INSTRUMENTS CORPORATION GREENWOOD MISSISSIPPI



for dimensional accuracy!

**METAL
STAMPINGS**

DKE

Specialized DKE experience — over 20 years in the field—is now available for the production of stamped metal parts. All types of cups, sleeves, Ranged shapes, intricate single pieces or fabricated components are included. High quality workmanship to exacting specifications—with any desired finish—is embodied in every job.

INQUIRIES INVITED

THE ENGINEERING CO.

DANIEL KONDAKJIAN
27 WRIGHT ST., NEWARK, N. J.

If users need bases like this...

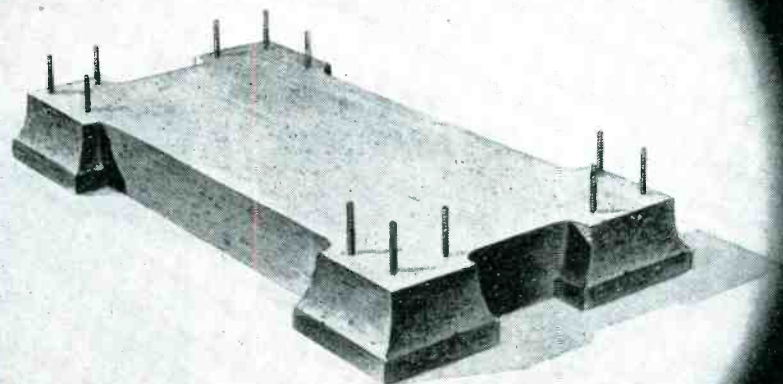

...your product needs Silentbloc Vibration Control

THE place to neutralize the effects of vibration is on your design boards—not on your customers' factory floors. Heavy bases and makeshift floor mounts are obsolete.

In modern motors and equipment, vibration control is made an integral part of product design through the use of General Silentbloc Vibration Mountings.

Silentbloc Mountings offer you engineered accuracy in solving any problem of vibration isolation, noise transmission and shock load. The construction of these rubber-and-metal mountings permits almost infinite variation in performance.

High-speed elongation of the rubber between metal sleeves gives an indestructible mechanical bond, even stress and more exact control.

Silentbloc vibration control is adaptable to products of every type. Mountings can be made of any metal and rubber, in any size to carry loads of ounces to tons. General engineers can help you design Silentbloc Mountings for your specific needs.

For full information, write for booklet, or see Silentbloc Section in Sweet's Product Designers File. The General Tire & Rubber Co., Dept. 194, Wabash, Ind.

Patented Silentbloc principle of elongating and confining rubber between metal members produces a virtually indestructible adhesion and uniform stress, resulting in precise performance and long life.



Mechanical Goods Division, Wabash, Ind.

THE GENERAL TIRE & RUBBER CO.

Makers of America's Top-Quality Tire

a total of 40 telegraph channels, one two-way phone channel, and one two-way facsimile channel. Frequency modulation is used and each telegraph signal goes out as two frequencies; one is a marking impulse and the other a spacing pulse to the receiving printer. A 70 cycle swing of signals spaced 300 cycles apart is involved.

Progress

In its six months operation to date, the radio relay circuit has performed so well that Western Union has filed an application with



One of the 4,000-mc antennas is examined by H. P. Corwith, assistant chief engineer of Western Union

the FCC for permission to install equipment of a similar type from New York to Pittsburgh, Pittsburgh to Washington, Washington to New York, and New York to Philadelphia. Its establishment in time will permit the removal of about 2500 miles of pole lines with some 54,000 miles of wires and 180 miles of aerial and underground cable.

Besides terminal equipment in the four cities, 21 intermediate relay stations in towers on mountains ranging from 14 to 55 miles apart would be constructed. The sites for these have been acquired.

...

Tube for SCR 270 Radar

COOPERATIVE ACTIVITY between the Army Signal Corps and Westinghouse Electric Corp. produced the special radar tube shown in the

Willor

For *Precision Accuracy*



WILLOR STAMPINGS

A modern plant, including designing, Tool and Die making — automatic stamping — machining — welding — assembling — spraying — large or small production runs — special custom built products, at low cost.

A Service . . .
Complete from Design to Finished Product

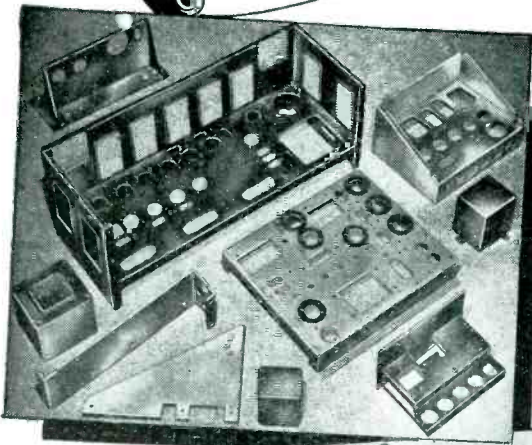

WILLOR

is your definite assurance of **SKILL** and **ACCURACY** for **PERFORMANCE**.

If your product is in the development stage or finished blue-print, write WILLOR for quotations. You will find our plant is prepared to produce to meet your needs.

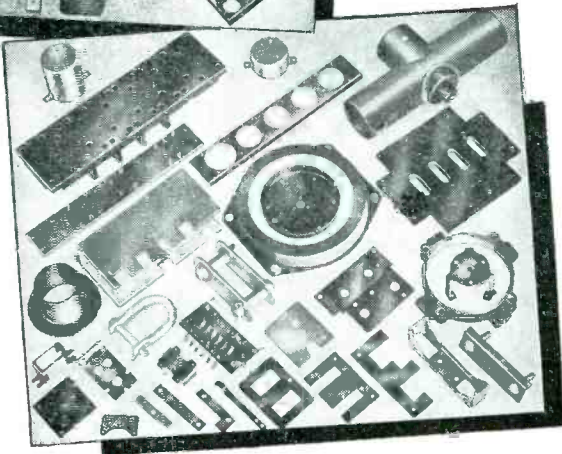

Our large assortment of stock dies may fit your requirements and result in real savings for you.



WILLOR

manufacturing Corp.

794 B EAST 140th STREET, NEW YORK 54, N. Y.
MELROSE 5-6085

OVER 40 YEARS OF EXPERIENCE

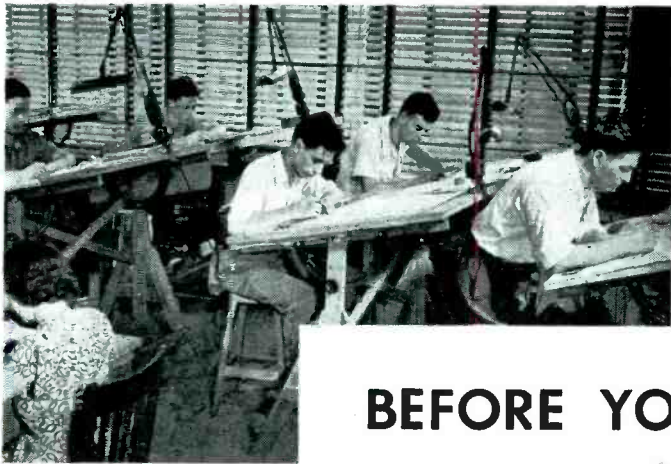

BEFORE YOU "FREEZE" YOUR PLANS

on transmission line equipment, it may be well worth your while to consult with our Micro Wave Research Division. Since the closing of the Radiation Laboratory at M. I. T., we are the only organization offering the services of one of the finest and most *completely equipped ultra high frequency laboratories to the entire electronic industry. Our standardized lines of High Frequency equipment can save you much time, trouble and expense. Prompt production and delivery is assured. Inquiries on your RF problems involve no obligation.

DEMORNAY-BUDD, INC., 475 Grand Concourse, New York, N. Y.

{ **"Completely Equipped"* means complete facility for Research—Design—and Manufacture. }

DE MORNAY
BUDD *inc.*



EQUIPMENT
FOR
97% OF ALL
RADAR SETS

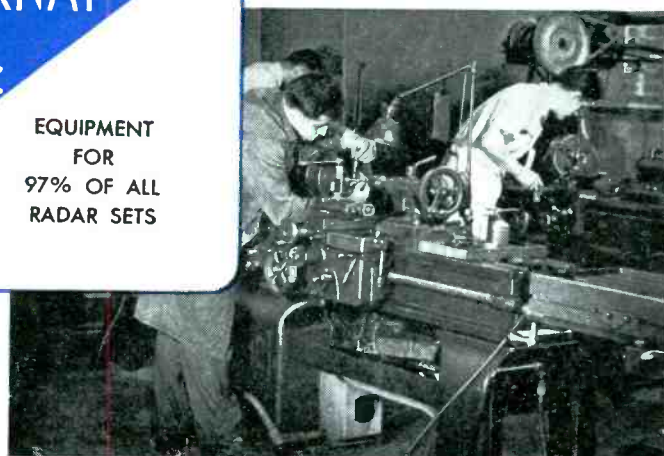
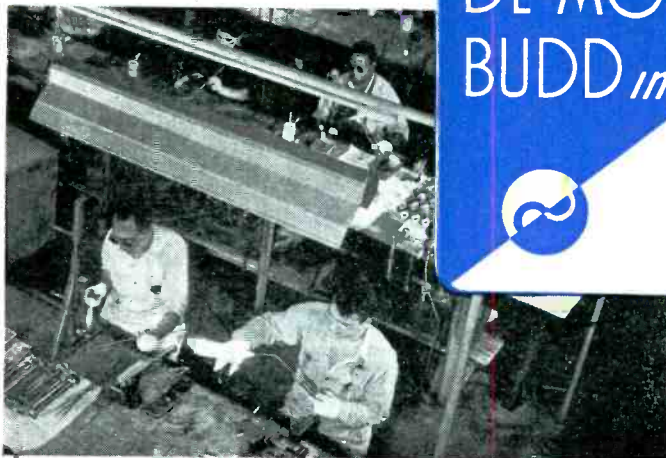
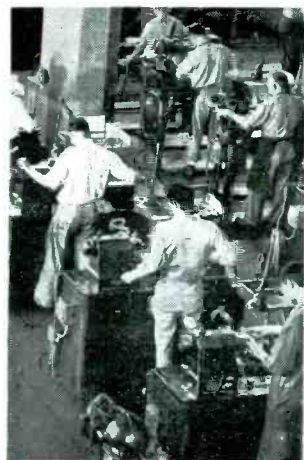

ALWAYS GETS A HAND!

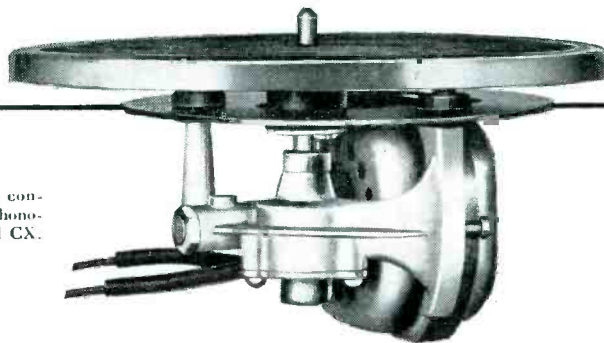

General Industries constant-speed electric phonograph motor—Model CX.

Users and the trade have always given hearty applause to General Industries phonograph mechanisms. Owners like the fine fidelity of every note or syllable—and sales and service departments are strong for their reliability and freedom from maintenance troubles.

You get this same old-time satisfaction from our *Smooth Power* turntable motors, recording assemblies and record-changer recorder com-

binations as we return to civilian production. As always, General Industries equipment will earn your approval.



THE **GI** GENERAL INDUSTRIES COMPANY
DEPT. M ELYRIA, O.

FOR
ELECTRONIC USE



SILVER

WIRE - SHEET - TUBING
SILVER BRAZING ALLOYS & FLUXES

PLATINUM

WIRE - RIBBON - FOIL
SEAMLESS TUBING

WE INVITE INQUIRIES REGARDING ALL APPLICATIONS OF PRECIOUS METALS TO ELECTRONIC PRODUCTS.

PRECIOUS METALS



SINCE 1875

THE
AMERICAN PLATINUM WORKS

N. J. R. R. AVE. AT OLIVER ST.
NEWARK 5, N. J.

PLASTICON* CAPACITORS

Have You an Application for a Capacitor Weighing 1/2 of Comparable Paper Capacitors?



Plasticons are favored by aeronautical engineers because they are lighter and smaller. On low voltage capacitors, there is an average saving of 10% in weight. As the voltage rating of capacitors increases, as much as 90% of the weight is saved. If weight is a factor, specify **PLASTICONS***
* Plasticons—plastic film dielectric capacitors



Condenser Products Company

1373 NORTH BRANCH STREET • CHICAGO 22, ILLINOIS

CUT HOLES FAST

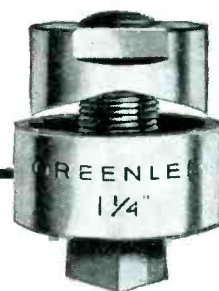

in radio chassis

No tedious drilling... no reaming... no filing! Saves hours of work. Cuts clean, accurate holes for sockets, plugs, other receptacles. Tool has three parts: *punch* cuts through chassis, *die* supports metal and prevents distortion, *cap screw* is turned with wrench to cut hole. Sizes for holes 3/4" to 3 1/2". For complete information write Greenlee Tool Company, 1932 Columbia Ave., Rockford, Illinois.

WRITE FOR FREE FOLDER S-119 →



REGISTERED TOOLS

GREENLEE

FOR THE CRAFTSMAN

KNOW-HOW BEGINS AT HOME

SPECIAL tools, ingenious manufacturing devices, and elaborate test equipment which makes delicate measurements almost as easy as telling the time . . . these things seem to interest our visitors particularly. We are always proud to point out that most of these aids to swift, precise production were developed by our own men and women.

There's a world of skill and experience at Con-

necticut Telephone & Electric Division . . . born of nearly fifty years of practice and progress. This know-how isn't confined to our engineering departments, either. Some of our most useful suggestions come straight from the production lines.

Purchasers of C. T. & E. products benefit from this skill and ingenuity . . . in better, more advanced devices, produced faster, for less.

CATHODE RAY SCREEN TESTER

Tests a telephone or radio headset for response over the entire range of audible sound in a matter of seconds, and charts the results on a television-type screen. Developed for our own use by our own people, this instrument has been a priceless aid in maintaining high quality and quantity in war production for the U. S. Signal Corps and Air Corps.

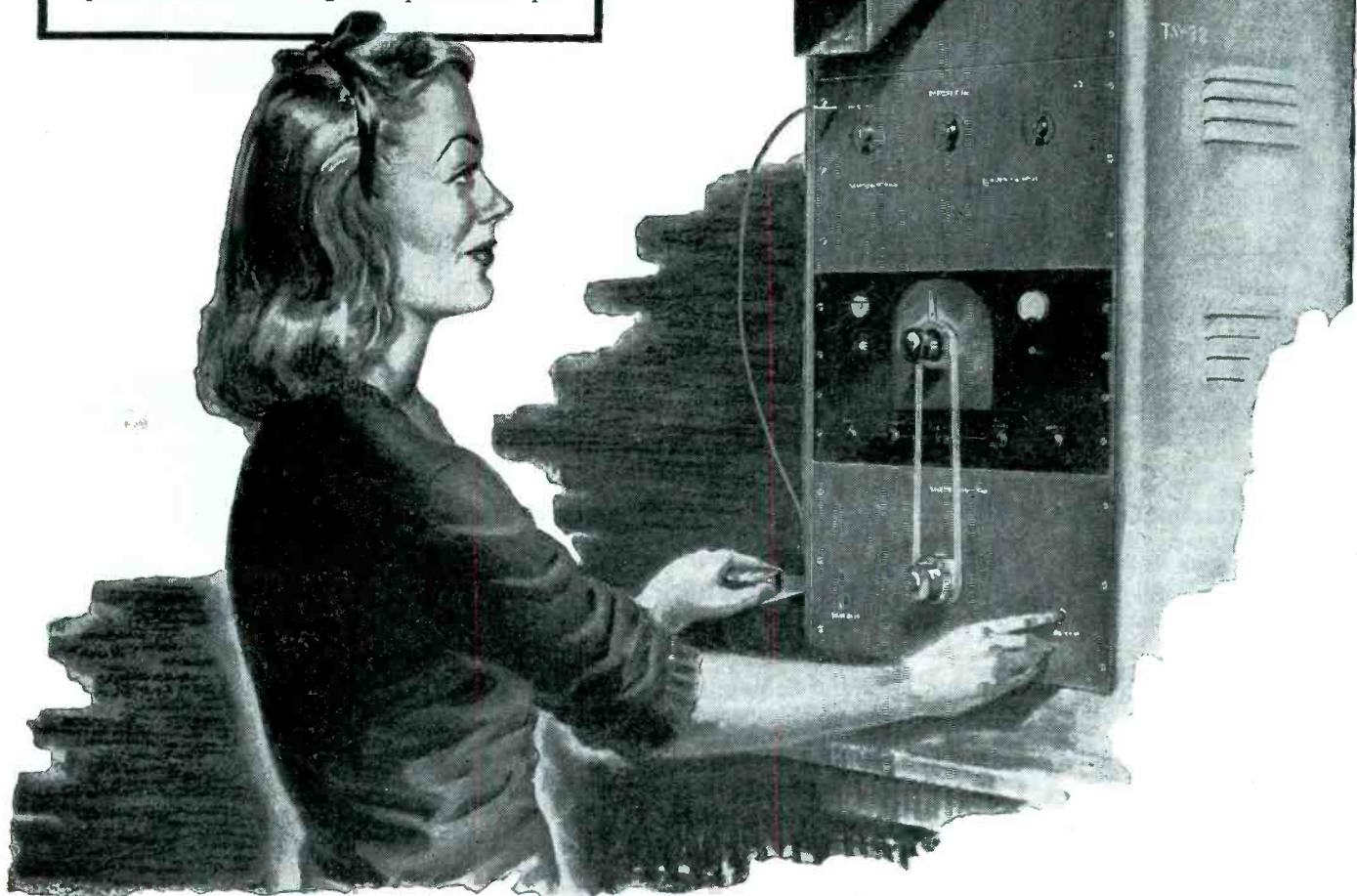

CONNECTICUT TELEPHONE & ELECTRIC DIVISION
GREAT AMERICAN INDUSTRIES, INC. • MERIDEN, CONN.

TELEPHONIC SYSTEMS • SIGNALLING EQUIPMENT • ELECTRONIC DEVICES • ELECTRICAL EQUIPMENT
HOSPITAL AND SCHOOL COMMUNICATIONS AND SIGNALLING SYSTEMS • IGNITION SYSTEMS

Why **MEPCO** "Tru Tolerance" **RESISTORS** are "Tops" with Manufacturers of Instruments, Radio, Electronic Equipment

They're Triple Improved!

ACETATE LABEL

Tougher, cleaner, more durable covering. Protects winding from mechanical handling. Prevents lugs from piercing label. Affords fungus protection to winding.

ADDED INTERNAL INSULATION

Cross-over wires are insulated from rest of winding with acetate cloth. An exclusive Mepco feature (patent pending).

DOUBLE SEAL IMPREGNATION

Prevents breakdowns and shorted turns. Withstands humidity and salt spray tests better. Is fungus resistant.

Non-Hygroscopic Ceramic Forms:

High insulating value, low expansion coefficient, high mechanical strength.

Highest Grade Alloy Wire:

Especially enameled to meet most rigid tests.

Extra Terminal Protection:

Lug type winding leads and lug embedded and molded into one unit. Lead wire type securely anchored in grooves with winding wire protected so as to prevent possible breaking in handling.

True Tolerance Precision Resistors:

Standard tolerance 1%. Special tolerances down to 0.10% on special orders.

Severe Breakdown Test

for every unit. Rejections minimized by special winding technique which prevents chafing of wire.

Careful Calibration

and precision winding keep all units well within specified tolerances.

Send us your requirements on special resistors for quotation.



GET THE MEPCO RESISTOR GUIDE. IT'S FREE! Shows all Mepco standard sizes and gives complete data as to electrical and mechanical characteristics.



MADISON ELECTRICAL PRODUCTS CORPORATION

MADISON, NEW JERSEY

Precision Resistors · Thermocouples
Voltmeter Multipliers
Electronic Specialties

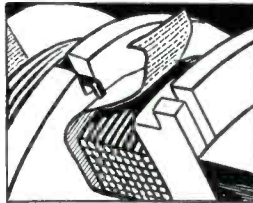

RADAR TUBE

(continued)

accompanying illustrations. It was used in long-range detection sets, one of which revealed the impending attack on Pearl Harbor and another guarded the Panama Canal a year before.

Of revolutionary design, the tube produced ten times the power of uhf tubes previously built and in-



Finished example of type WL 530 radar tube. This unit served in the famous SCR 270 which detected the approaching Japanese attackers of Pearl Harbor. Production of copper-to-glass seal was one of the difficult parts in development of the WL 530 radar tube. Here a worker in the Fairmont, W. Va., plant of Westinghouse molds the anode seal.

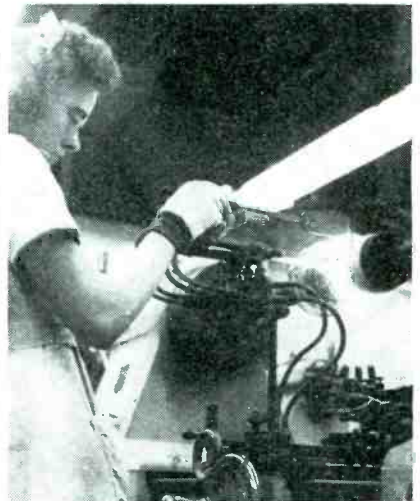

involved manufacturing problems at first regarded as insurmountable. Besides geometrical and physical characteristics departing radically from known techniques, the tube called for extremely difficult copper-to-glass feather-edge seals and momentary peak currents which de-

E Madison Electrical Products Corp.
Madison New Jersey

NAME.....

POSITION.....

ADDRESS.....

CITY.....STATE.....

THESE MODERN RIVETS IMPROVE MODERN ELECTRICAL FASTENING

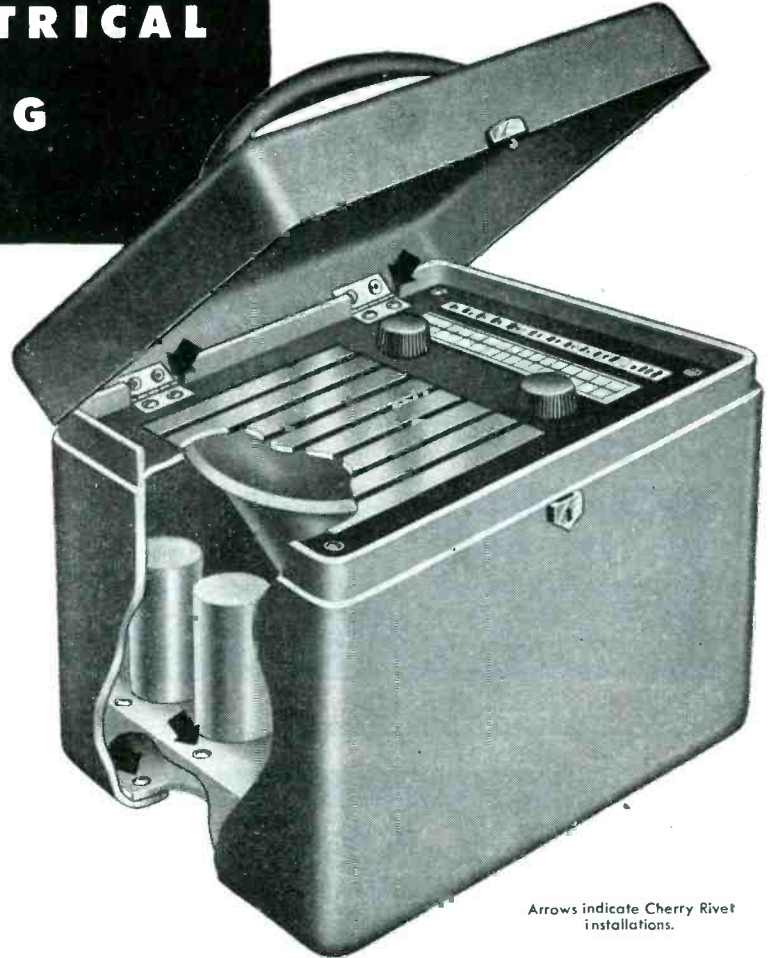
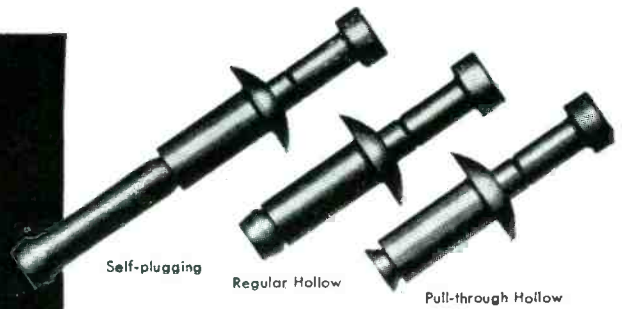

CHERRY BLIND RIVETS are designed to meet the installation requirements of modern electrical fastening, as well as to simplify and speed up blind and hard-to-get-at rivet applications.

They are upset in a modern way—with a pull exerted by small, easy-to-handle Cherry Rivet pneumatic or hand guns. Installation can be made by one operator from one side of any location, blind or not, without bucking.

Cherry Rivets conform to modern contours; hold securely on curved surfaces, in tubes, bends and ducts; fasten double surface structures from one side.

Modern materials such as plastics, rubber, leather, fabrics, plywood, as well as all sheet metals can be fastened quickly, easily, and with complete success.

Cherry Rivets meet the stress and strain requirements of modern uses. They aid in simplifying and speeding up modern production and repair methods. Because of their wide range of applications, they allow greater flexibility in modern designing.

The installed appearance of Cherry Rivets is up-to-date, modern—enhances the appearance-value of the finished product. And their installed cost is low.

For more information, contact your nearest jobber or write now for illustrated Manual D-45, Dept. A-120, Cherry Rivet Company, 231 Winston Street, Los Angeles 13, California.



CHERRY RIVETS. THEIR MANUFACTURE & APPLICATION ARE COVERED BY U.S. PATENTS ISSUED & PENDING

Hollow Cherry Rivets are best adapted for radio installations. They exert an exceptionally strong clinch—hold securely—can be easily removed for further servicing.

Small, one-hand G-25 gun shown below has head at right angles to gun axis to provide easy access to tight, crowded locations typical of radio installations.

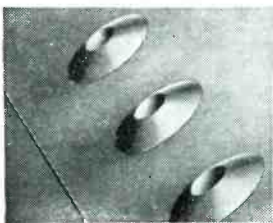

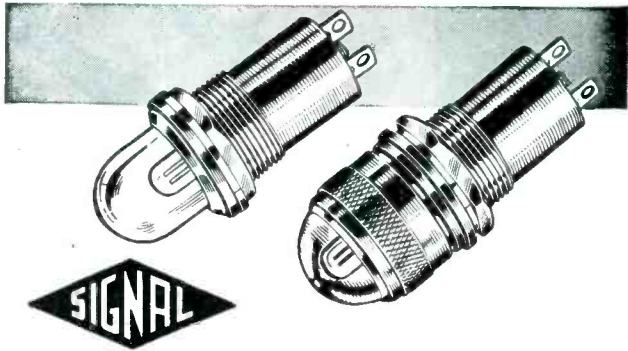

NEON PILOT LIGHTS

EMBODY THESE IMPORTANT FEATURES:

Penetrating orange-red glow . . . Long life . . . Low current consumption . . . Resistance to vibration and shock . . . Operate direct on high voltage circuits . . . Emit practically no heat —

These advantages of Neon Glow Lamps are enhanced by "SIGNAL" Pilot Light Assemblies. We manufacture a complete line, featuring types fitted with Full-View Plastic Heads. Specialists in supplying completely assembled units, housing G.E. or Westinghouse Lamps. Send specifications for prompt estimates and suggestions . . . Write for Catalog.

SIGNAL INDICATOR
Corporation
894 BROADWAY . . . NEW YORK 3, N. Y.
Telephone: ALgonquin 4-4770

Regulated Supply



Variable Voltage Regulated Power Supply

- Output 0 to 400 volts
- Bias 0 to —150 volts
- Up to 200 ma. load
- 1% regulation
- 6.3 volts a. c.
- Continuous voltage variation

Price
\$195
F.O.B. Factory

Supplied complete
with rack panel and
handsome cabinet.
Model P-11

AMERICAN RADIO CO.

611 E. Garfield Ave.
Glendale, California

A Name to
Look for on
Electrical
COILS and
Transformers



Famous for
years as
COILS
by
DOYLE

Be sure that the coil you buy bears the trademark name — "GRACOIL", for only then can you know that you have the best in electro-magnetic windings. Every "GRACOIL" is wound to the specified number of uniform turns from precision-gauged wire. Every "GRACOIL" is fully insulated, thoroughly impregnated, and properly laminated when supplied as a complete transformer. The most rigid inspections and tests make sure that each "GRACOIL" is worthy of the name it bears.

If your design calls for a special electro-magnetic application, let competent "GRACOIL" engineers make specific recommendations for you. Write today!



LAYER-WOUND COIL



LOW VOLTAGE
TRANSFORMER



RELAY COIL



GENERATOR
FIELD COIL

THE GRAMER COMPANY

Electrical Coils and Transformers

2736 N. PULASKI RD., CHICAGO 39, ILL., U. S. A.

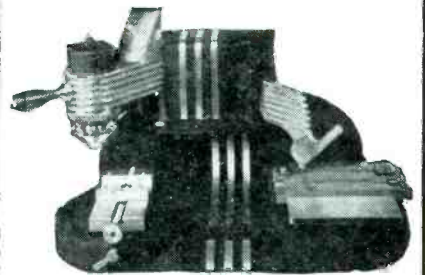

DUPLICATING and PROFILING AUTO ENGRAVER

*Accurate Engraving
with Unskilled Operators*

Unskilled operators will profile or accurately reproduce in smooth lines any design, number, letter, emblem, signature; on iron, brass, copper, aluminum, soft steels and all plastics. Here are some of its other uses . . .

- Drills a series of holes, or profile small parts
- Cuts an even channel for wiring on panels. Increases accuracy and production.
- Works from original drawing or templates.
- Etches glass and similar items.
- Will not cause distortion.

For complete information on this and other models and prices write Dept. K.

AUTO ENGRAVER CO.
1776 BROADWAY, NEW YORK 19

Making Steel Talk

with CHRONOVOX

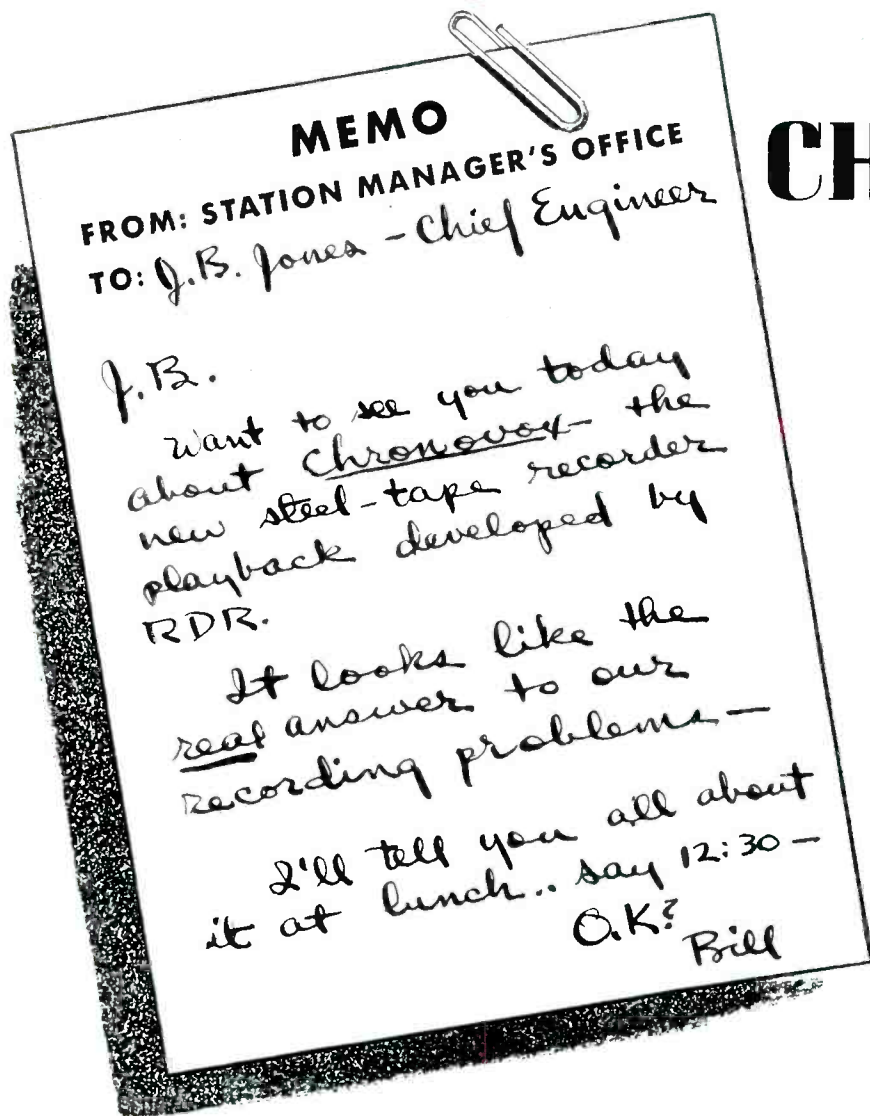

Know these Facts about Chronovox!

- The cost of discs is eliminated!
- The steel tape is permanent ... indestructible!
- Recordings are erased at will!
- Surface noise lower than any other method of recording!
- Recordings reproduce indefinitely with less than 3DB attenuation!
- It's a complete, self-contained unit!
- Plugs in any 110 volt AC source!
- For a permanent record, "dub" from the final—perfect—Chronovox impression to your disc recorder!

Yes, memos like this one are being written daily. Radio executives KNOW that Chronovox will solve many of their recording problems. The RDR Chronovox is a precision instrument employing an improved method of recording sound on an indestructible steel tape. Recordings are made magnetically not physically—and the Chronovox will repeat the last recording indefinitely or until a new one is made.

FOR MORE INFORMATION - CONTACT:

RADIO DEVELOPMENT & RESEARCH CORP.

233 WEST 54TH STREET · NEW YORK 19, N. Y.

AFFILIATE: TRANSFORMER PRODUCTS, INC.
143 W. 51st Street, N. Y. C.

MIAMI: SALES - SERVICE
1415 N. E. 2nd Ave., Miami, Fla.

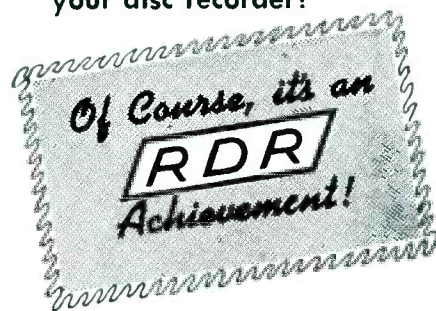

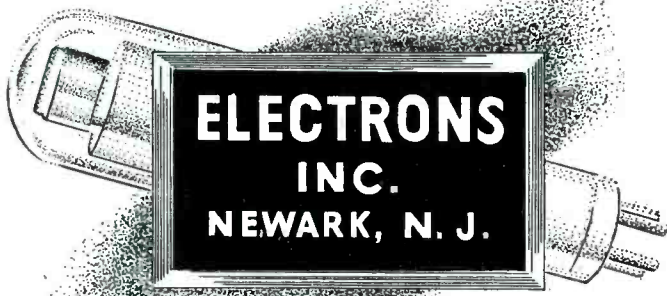

Specialized Research

... SINCE 1928

- Specialization invariably results in better functioning. For over 17 years we have concentrated on continuous, systematic research in the development of hot-cathode, gaseous-discharge Rectifier and Control Rectifier Tubes, which would satisfy the demand for power tubes of outstanding reliability.
- EL Rectifier Tubes have a unique, tough cathode coating, devised to withstand the particularly heavy ion bombardment experienced by gas-filled tubes for industrial use. This is characteristic of the many details of design and manufacture which result in rectifier tubes of longer life, with the ability to handle short circuits and momentary overloads in the critical interval that occurs before the fuse is cleared.
- EL Rectifier Tubes have met with widespread acceptance, not only by industry but for Government use, as evidenced by the fact that several of our Rectifier Tubes are on the Army-Navy Preferred List. We invite you to contact us regarding your Rectifier and Control Rectifier Tube requirements and suggest that you . . .

Write for Descriptive Literature

ELECTRONS, INCORPORATED
127 SUSSEX AVENUE NEWARK 4, N. J.

EL Rectifier TUBES

manded a specially-treated tungsten filament able to withstand five times the voltages believed possible.

The project was taken over by Westinghouse electronic engineer Ilia E. Mouromtseff, who had, back in 1933, done line-of-sight transmission work which led to the detection of automobiles passing by on the highway outside the East Pittsburgh plant of the company. Tubes of similar construction are expected to contribute to the future advancement of f-m and television equipment.

. . .

Drafting Aids to Relay Profiling

By F. J. BINGLEY
*Chief Television Engineer
Philco Radio & Television Corp.
Philadelphia, Pa.*

PROFILING of the terrain along the line-of-sight television path recently built between Washington and Philadelphia (See *ELECTRONICS*, Oct. 1945) was necessary because it was desired to obtain at least 100 feet of ground clearance at all points on the transmission path. This clearance was to be provided by the use of two 100-foot antenna towers, one for receiving and the other for transmitting television signals at each relay site selected.

After a study of U. S. Coast and Geodetic Survey maps, four tentative hilltop sites for relay stations were chosen. Then a device, which has been named the Contourograph, was used to prepare profiles of the ground contour between each pair of sites to learn the exact ground clearance along each section of the proposed network.

The instrument is shown in the accompanying illustration. It consists of a double-ended T-square, actually an H-square, with an added cursor. The two vertical legs of the H are used to mark on the map the two end points of a path which is to be profiled, with one leg movable to permit adjustments in the length of the contour section.

Distance and Elevation

The slider which is moved along the horizontal leg of the H-square, is graduated in feet of altitude to an arbitrary scale. Thus as it is

Reconversion Problems?

BREEZE is a Reservoir of Manufacturing Skills and Facilities

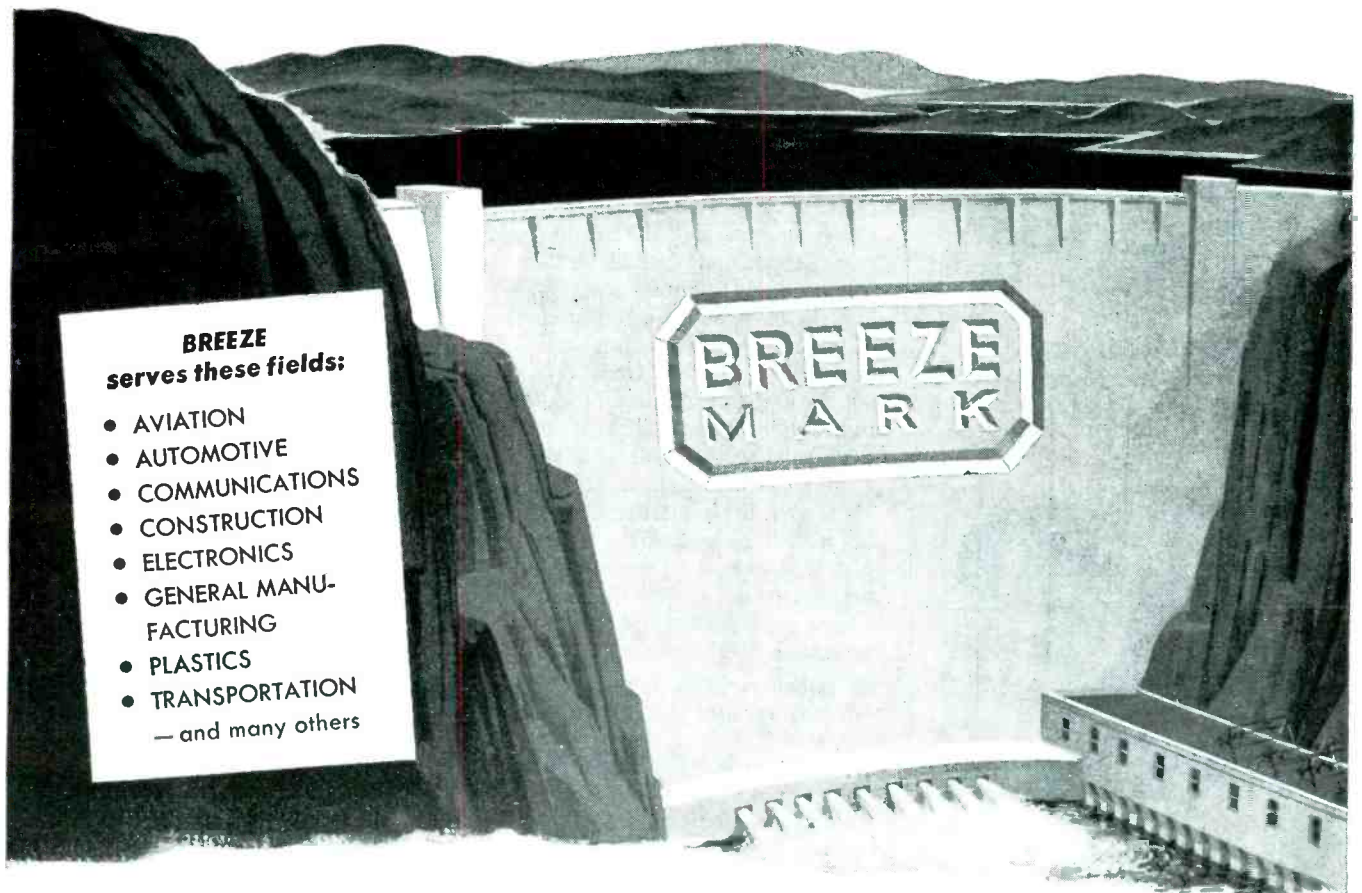

THROUGH diversified manufacturing operations covering a period of nearly two decades, Breeze has built up a vast reservoir of skills and facilities which now may be tapped by manufacturers faced with reconversion problems. Already Breeze has helped two producers of consumer goods to recapture pre-war markets . . . and turn a handsome profit while their competitors were still trying to figure out what to do about re-tooling for peacetime production. And in the same manner that it has helped others, Breeze may be able to help you.

Breeze has available, on a subcontracting basis, resources of versatile equipment and "know-how" ranging from the planning, engineering and production of intricate electronic devices . . . to the manufacture of hardened steel parts.

During the war years these resources enabled Breeze . . .

. . . To solve many complex problems for the Armed Forces with the ingenuity born of 19 years of experience in the design and manufacture of products developed to meet the exacting requirements of the aviation industry.

. . . To produce in vast quantities for war such precision items as Breeze Radio Ignition Shielding, Flexible Conduit and Fittings for aircraft, automotive, tank and marine engines; Aircraft Tab Control Mechanisms, Electrical Connectors, Flexible Shafting and Casing, light-weight Armor Plate and countless other specialties.

Today, properly applied, the Breeze processes, equipment and techniques which made so many

important contributions to Victory may enable you to get goods back on the market months ahead of your competition. The wide variety of services Breeze offers are described graphically in "Planning for Reconversion". Send for your free copy of this interesting booklet today. It may suggest a direct adaptability of Breeze skills and facilities to your commercial production needs.

BREEZE
Corporations Inc.

NEWARK 7  NEW JERSEY



FLAT Contacts

reduce noise, prolong service life

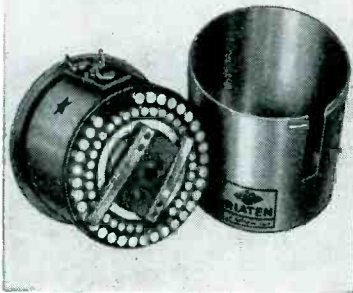
**VARIATEN #1218**

"T" Circuit— $1\frac{1}{2}$ db per step; 30 to 600 ohms impedance. Price, F.O.B...\$17.50

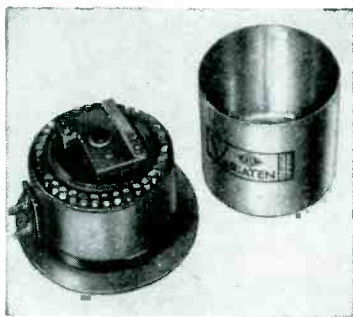
**VARIATEN #1156**

Ladder Circuit— $1\frac{1}{2}$ db per step; 30 to 600 ohms impedance. Price, F.O.B...\$12.50

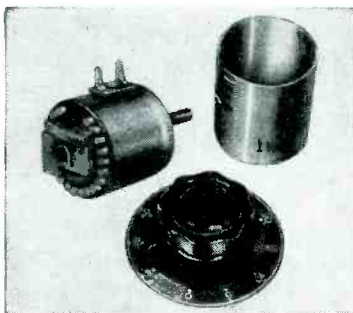
**VARIATEN #1384**

Ladder Circuit— $2\frac{1}{2}$ db per step; 30 to 600 ohms impedance. Price, F.O.B...\$7.50

VARIATEN contacts and brush surfaces make contact over their entire area because the contacts are ground flat and the brushes stone-lapped, *not* buffed. Buffing produces rounded surfaces and therefore a "point" contact highly susceptible to noise. Variaten brushes move from one contact to the next without rocking motion. The resulting perpendicular spring pressure at all positions allows us to take advantage of the natural resiliency of metals to provide a completely flat contact over the entire brush surface at all times and so reduce noise and lengthen service life.

No carbon resistors are used in any Variaten Mixer...

All are of stable, wire-wound construction. Most are step type. Where quiet operation is the major consideration, we recommend ladder type mixers because the circuit requires only one contact brush operation on the input side of the circuit and any possible brush noise is therefore attenuated along with the signal.

By all means compare circuits, construction and features of these mixers. From the hundreds of Variaten attenuators you may select the attenuators best adapted to your specific needs. Write for the Variaten Catalog today.



CINEMA ENGINEERING CO.
Established 1935 • Burbank • California

moved along the route between relay sites, the altitudes are read from the contour line intersections on the map and transferred directly as points to a sheet of paper placed above the map and between the ends of the H-square as shown. A series of points are plotted on this paper, and then connected to provide a profile of the ground contour between proposed relaying stations. Distances between transmitting sites are represented horizontally on this profile, while the ground elevation is shown by vertical distance from the base line.

Besides time saving, a second advantage of the Contourograph is that it greatly reduces the chances for error in locating profile points.

Additional Template

Since the curvature of the earth's surface is another factor important in profiling for line-of-sight television transmission it has been necessary to use an auxiliary piece of equipment. This is a curved tem-

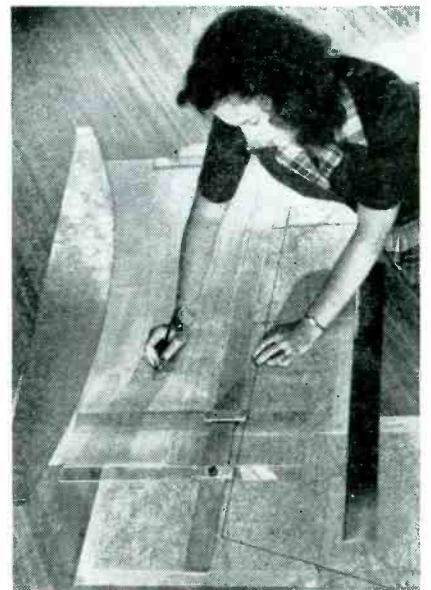

Profile charts for line-of-sight relay routes are plotted with the aid of this modified T-square. Template at left represents a straight line as affected by curvature of the earth

plate, cut on a scale corresponding to the altitude scale of the Contourograph cursor, with its radius of curvature representing the inverse of the earth's curvature. This template is placed so its curved edge passes through the

GOOD NEWS FOR BROADCASTERS

REL 88-108 Megacycle Band

FM

Broadcasting Equipment in Assembly

PLACE YOUR ORDER NOW

This REL broadcasting equipment can now be ordered . . . to meet or exceed present FCC requirements.* Entirely new . . . with important design advancements.

Transmitters

With the new Armstrong Modulator . . . providing simple, stable . . . even more efficient performance than ever before!

Power Output	Cat. No.
250 watt	549A-DL
1,000 watt	518A-DL
3,000 watt	519A-DL
10,000 watt	520A-DL

Speech Equipment

Cat.
603—Studio Speech Console, Table type, 6 Position
604—Station Speech Console, Table type, combined with Cat. 600 Monitor and transmitter desk control

Monitoring Equipment

Cat.
600—FM Station Frequency and Modulation Monitor

Wire or write today for technical data, prices and delivery . . . or better yet . . . do as other broadcasters have already done—send your order, subject to later confirmation, thus assuring early delivery.

*REL FM equipment guaranteed to meet or better the FCC standards of good engineering practice for FM Broadcast stations.

SALES REPRESENTATIVES



MICHIGAN
M. N. Duffy & Co., Inc.
2040 Grand River Ave., W.
Detroit, Mich.

MIDWEST
REL Equipment Sales, Inc.
612 N. Michigan Blvd.
Chicago, Ill.

PACIFIC COAST
N. B. Neely Enterprises
7422 Melrose Avenue
Hollywood 46, Calif.

Pioneer Manufacturers of FM Transmitters Employing Armstrong
Phase-Shift Modulation

RADIO ENGINEERING LABS., INC.
Long Island City, N. Y.

A NEW 104 db GAIN

Portable

AMPLIFIER—15 WATTS



The new Altec Lansing A-323 portable amplifier is specifically engineered to operate adequately from low level phonograph pick-ups, microphones or radio tuners. Up to its rated power, it reproduces high quality sound over the full frequency range without overload or distortion. It is a small, compact, 6-tube portable amplifier especially designed and manufactured to efficiently operate with the Duplex Speaker, public address systems, home radio receiving sets and other applications where high quality, low cost amplification is desired.

\$118⁰⁰

WITH INPUT TRANSFORMER

\$158⁰⁰

AT ALL LEADING DEALERS
OR SEND YOUR ORDER TO

ALTEC

LANSING CORPORATION

1210 TAFT BLDG., HOLLYWOOD 28, CALIF.
250 WEST 57 STREET, NEW YORK 19, N. Y.
IN CANADA: NORTHERN ELECTRIC CO.

RELAY PROFILING

(continued)

end points of the profile, and a curve is traced on the paper. If desired, an allowance can be made in this template for the refraction of television waves by the earth's atmosphere—usually accomplished by using as a base figure $4/3$ the actual radius of the earth. However, by using the actual radius for this system, Philco was conservative in the matter of clearance on the profile drawing.

To make an instrument capable of simultaneously providing altitudes for profile points and curvature corresponding to the earth's, it is merely necessary to modify the Contourograph by making the upper edge of the horizontal leg curved to represent the earth's curvature. The cursor travels along this curved surface. Then both operations are combined into one simple plotting process.

• • •

Measurement Applications of the Dynatron

By Wayne M. Ross
Wallace, Idaho

THE DYNATRON oscillator is a very interesting and useful circuit that seems to have been overlooked by many research and service engineers. As is commonly known, the operation of this type of oscillator results from secondary emission in certain types of tetrodes or screen grid tubes having no suppressor grid, notably the old 24A. When the plate voltage is less than that of the screen, a large amount of secondary-emission current flows from the plate to the screen grid. This causes the plate current to increase as the plate voltage is decreased and to decrease with an increase, in plate voltage, thus, in effect producing a negative resistance. If a resonant circuit is placed across this resistance and the resistance made sufficiently negative to overcome the losses of the circuit, it will oscillate with no other form of reaction or feed back.

As, in a resonant circuit, the greater the resistive losses the lower is the dynamic resistance, so the more damped circuit will require a lower negative resistance to produce oscillations. This value of negative resistance varies consid-

GOULD-MOODY

Improved

Professional Quality

"Black Seal"

ALUMINUM

INSTANTANEOUS

RECORDING BLANKS

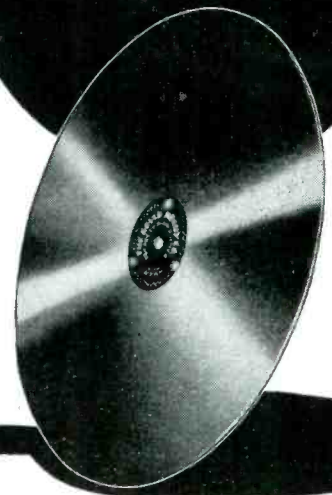

Technological advancements brought about by our wartime assignments provide critical engineers with "Black Seal" blanks of improved cutting and reproduction qualities plus more satisfactory play-back life.

Rapid Deliveries to

Broadcasting Stations
Recording Studios
Motion Picture Sound Studios
Schools and Colleges
Governmental Agencies

Old Aluminum Blanks Recoated with
"Black Seal" Formula on Short Notice



395 BROADWAY, NEW YORK 13, N. Y.
Cable Address: Recordisc, New York, N. Y.
Export Dept: Royal National Company, Inc.
89 Broad Street, New York

Over 300% increase in 3 years



... THE SWING IS TO VARNISHED FIBERGLAS* CLOTH FOR ELECTRICAL INSULATION

It's because of the unique combination of characteristics, found only in Fiberglas, so many electrical engineers have standardized on Fiberglas-base Electrical Insulation Materials.

THICKNESSES OF FIBERGLAS CLOTH

Fiberglas Cloths for varnishing are produced in thicknesses from .0015" to .015" permitting a wide variety of base cloths for various varnished thicknesses. Thickness of base cloth and finished thickness of varnished cloth should be determined by space-factor, dielectric strength and mechanical requirements of the particular application.

VARNISHED CLOTH AND TAPE

When properly impregnated, Fiberglas-base Insulation material has exceptional dielectric strength and insulation resistance. In addition it has unusually good moisture and temperature resistance and high tensile strength. The strength-to-thinness ratio of varnished Fiberglas Cloth is unmatched.

Varnished Fiberglas Cloth, in thicknesses from .003" to .030", is used wherever a high-dielectric material with good mechanical characteristics

is required for equipment operating in high temperature, under adverse operating conditions, or where a greater factor of safety is desired. Typical applications are: phase insulation in a-c motors; high-dielectric and high-temperature coil insulation; ground insulation on the slot sections of preformed coils; layer insulation in air-cooled transformers, etc.

PERMITS USE OF THINNER INSULATION

Because of its higher dielectric strength and because it retains its mechanical and electrical characteristics under prolonged exposure to adverse conditions, thinner varnished Fiberglas Cloth or Tape than that required by the use of other materials will give equal or greater insulation.

Varying degrees of flexibility in varnished Fiberglas Cloth, of the same finished thickness and type of varnish, are possible by varying the thickness of the Fiberglas Cloth used as the base—yellow or black varnish treatment.

COMPLETE INFORMATION

If you do not have complete information on all types of Fiberglas-base Electrical Insulation Materials, write for Catalog EL 44-7 today. *Owens-Corning Fiberglas Corporation, 1860 Nicholas Building, Toledo 1, Ohio.*

In Canada, Fiberglas Canada Ltd., Oshawa, Ontario.

There is a **FIBERGLAS** Insulation Material for every need

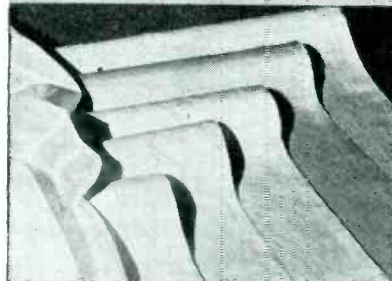

Untreated, continuous filament, Fiberglas Cloth is made in thicknesses from .0015" to .015" — staple fiber cloth from .012" to .023".

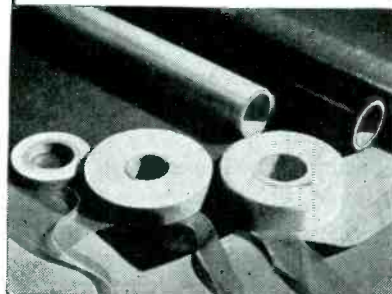

Varnished Fiberglas Cloth is available in 36" widths or cut to any desired tape width.

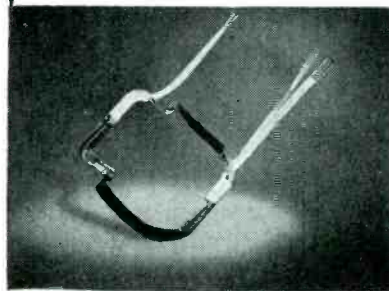

Treated and untreated Fiberglas Tapes in various widths and thicknesses are used in winding all types of coils.



Write for Catalog E 44-7

Each distributor of Fiberglas-base Insulation Materials has his own source of supply, since Owens-Corning Fiberglas Corp. does not process these materials.

FIBERGLAS

*T. M. Reg. U. S. Pat. Off.

ELECTRICAL INSULATION MATERIALS

HAVE YOU INQUIRED HOW

THERMONICS

CAN IMPROVE, SIMPLIFY

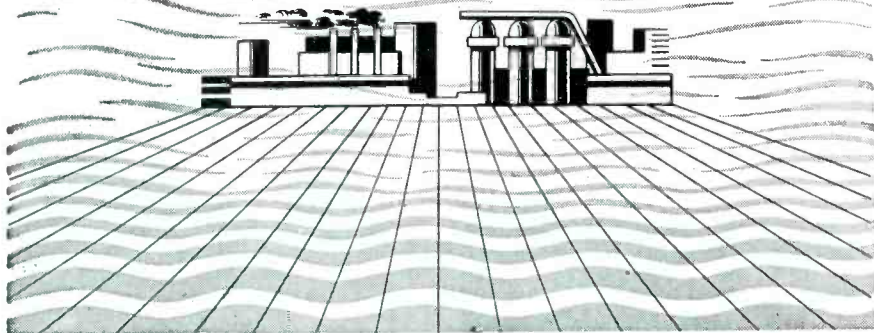

YOUR PRODUCT, YOUR PLANT, YOUR POSTWAR PLANNING

***THERMONICS** is the science of mutable temperature control developed by Fenwal, Incorporated, by the direct process of determining the needs of industry and science for unerringly accurate thermal control of wide mutations. Many thousands of applications and tests have proven the efficacy of the *Fenwal Thermoswitch*, prime factor of this refined and exact science of Thermonics, which takes its place of due importance in the field of temperature control and thermal regulation.

Thermonics as a science in itself earns and deserves the attention of:

- all processes and production requiring regulation of extreme or moderate temperatures;
- makers of equipment requiring light weight, compact, efficient thermal regulation;
- makers and users of machinery, equipment, vehicles, wherein a safety factor of controlling or indicating excessive or dangerous mutations in temperature is essential.

THERMOSWITCH is the prime factor in Thermonics. So many are the functions of THERMOSWITCH, and so comprehensive is the field of Thermonics, that practically all processes of manufacture requiring accurate thermal regulation are served by THERMOSWITCH. Few, if any products whose efficiency depends upon temperature control, exist today or are planned, that can omit the consideration of Thermonics in basic engineering and the use of THERMOSWITCH for functional competency and economy of operation. THERMOSWITCH in its many types and adaptations, offers a lightweight, compact vibration-proof, highly sensitive yet rugged regulatory and detecting unit of almost unlimited utility.

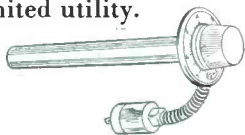

Fenwal's data folder on Thermonics will prove of value to engineers. Your copy is ready for you.

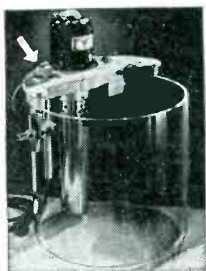
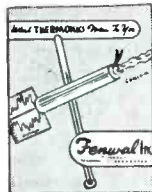

Fenwal, Inc.

THERMOSWITCHES
FOR COMPLETE TEMPERATURE CONTROL

43 Pleasant Street, Ashland, Massachusetts

erably with different tubes. Some of the early type 24A's will provide a resistance of approximately 5000 ohms. Almost any of them will provide 10,000 ohms which is sufficient for most work. The negative resistance is also directly controllable by means of the control-grid bias, being lowest in value when the bias is zero.

A dynatron circuit, arranged for convenience in doing experimental work, is shown in Fig. 1. In addition to the components shown, useful accessories are: a calibrated

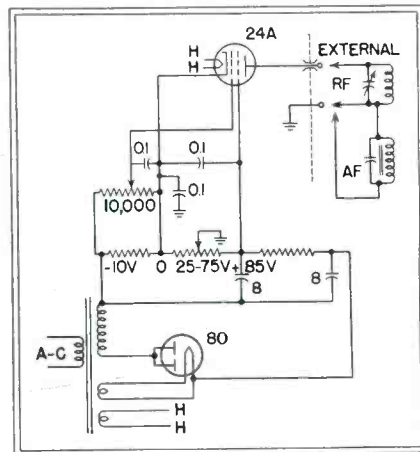

FIG. 1—Once popular in test oscillators, the dynatron circuit operates most efficiently with the early 22 and 24A-type tubes. The circuit above provides convenience in making many measurements

wavemeter, preferably a non-absorption type, a variety of coils and a capacitor calibrated over the desired frequency ranges, and a large slide-type dial. The 24A tube should be mounted horizontally so that the lead between the plate and external connection is short. The basis for dynatron measurement applications are the dynamic resistance of a tuned circuit and the resonant frequency or change in frequency.

Grid Voltage as Indicator

The dynamic resistance is determined by the most negative control-grid voltage that will still maintain oscillation. This voltage may be controlled by a wire-wound potentiometer, the scale of which may be calibrated to read the negative resistance, or a voltmeter may be used to measure the bias voltage



W. J. HAGGERTY, Manager
Industrial Sales, Ashland, Mass.



C. B. DIX, Sales Engineer
Ashland, Mass.



ARTHUR H. RIPPAS, New York



J. J. BURNS, San Francisco



RUSSELL T. WOODWARD, Cleveland



M. C. HUIE, Dallas



HAROLD D. STANTON, St. Louis



A. W. PINGREE, Boston



ROBERT J. BUCKLEY, Philadelphia



H. K. DEWEES, Atlanta



J. H. ELINN, Denver



JOHN W. BABB, Chicago

These experts will answer **YOUR** questions about **Telechron Motors**

Telechron's Motor Advisory Service is staffed by *application engineers*. They can tell you how Telechron self-starting synchronous electric motors may be applied to your product—how quickly and economically they can be installed—how they'll perform under varying conditions of moisture and temperature.

There's one of these experts within easy reach. It's his job to help you build a better product at lower cost. Tell him what you need in the way of speed and torque, and the operating conditions the motor must meet—he'll recommend the one motor you should have. Send him a sample of your product—engineers at the factory will install a motor and test it in actual operation.

The Motor Advisory Service is one of the *plus values* you get with long-life, dependable Telechron motors. For full details, consult one of Telechron's field engineers. Motor Advisory Service, Dept. C, Warren Telechron Company, Ashland, Massachusetts.

Telechron

REG. U. S. PAT. OFF.

WARREN TELECHRON COMPANY, ASHLAND, MASS.

IF IT WORKS WITH A SPARK —
IT WORKS BETTER WITH A
BUCHMANN

"Sure-fire"
SPARK WHEEL



Smooth, instantaneous, unflinching action for any sparking device

For over 35 years, the world's finest sparking devices have been built around the famous Buchmann "Sure-Fire" Spark Wheel.

Manufacturers look to Buchmann for this vital part because they know they can depend on the consistent uniformity and precision of Buchmann Wheels. As the world's largest manufacturer of spark wheels, Buchmann offers you a quality-price ratio that can't be equalled—either in stock sizes and types, or in wheels, round and flat files machined to your specifications.



BUCHMANN
SPARK WHEEL CORPORATION

4-20 47th Avenue, Long Island City 1, New York

and a chart made to read the negative resistance. The value of negative resistance may be computed from the $E_p I_p$ curve at various bias voltages, or, if approximations are sufficient, standard coils whose dynamic resistance is known may be used. The negative resistance is equal to the dynamic resistance of the circuit when the bias control is set just at the point of oscillation.

The frequency or change of frequency is determined by the loosely coupled wavemeter or a nearby receiver. The wavemeter is also necessary to determine the point at which oscillations begin.

A parallel-resonant circuit may be tested directly by connecting it to the terminals shown in Fig. 1. The dynamic resistance will be indicated by the potentiometer setting at which oscillation begins and the frequency of the circuit will be shown by the wavemeter.

Capacitance and Inductance

Perhaps the more useful is the substitution test. In this case, a tuned circuit of known values is caused to oscillate. The component to be tested is then clipped across this circuit. Oscillation will probably cease but may be reestablished by decreasing the control-grid bias. This decrease in bias will correspond to the effective resistance of the component under test. If the component contains reactance, the frequency will be altered. The tuning capacitor may be adjusted to restore the original frequency. This adjustment may be calibrated to read capacitance in one direction and inductance in the other. This will not indicate true inductance or capacitance but the effective value at that frequency.

Signal Source

Additional uses to which a dynatron may be put include application as an a-f, r-f, or modulated r-f oscillator. When operated with sufficient control-grid bias so that oscillation is only just maintained, the frequency stability is excellent. Since the amplitude of oscillation may be controlled by the control-grid bias, this factor may be useful for automatic amplitude control. If a modulated oscillator is desired,

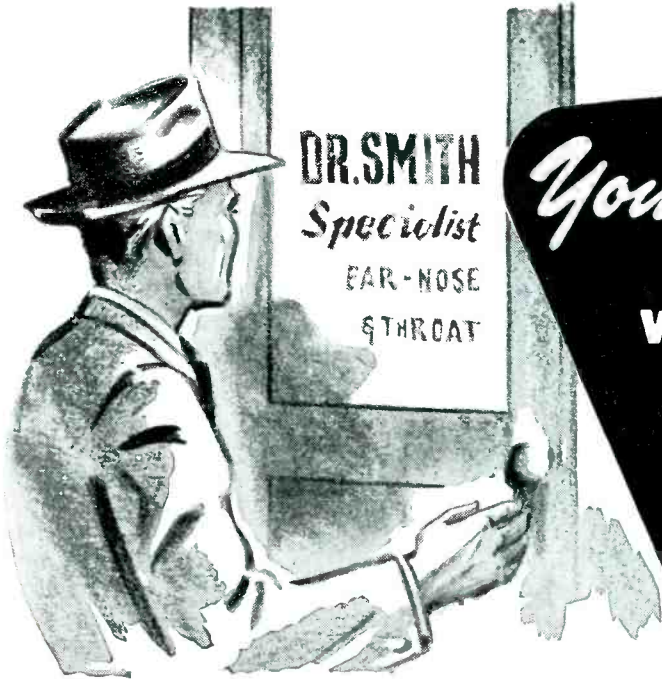

You feel more secure
WHEN YOU RELY
ON A SPECIALIST!

...and We Specialize Exclusively in Radio Transmitting Equipment

When you address an inquiry or a comment to GATES, you're sure to reach a man who knows Radio Transmitting Equipment—because there's no other kind here! Our business is devoted exclusively to the manufacture and sale of Transmitting Equipment. As a result, there are no diversions or interruptions to pull us off our objective—the building of better and better products for your needs!

You get sounder advice from a doctor who specializes in your ailment. You'll get better service from GATES—specializing in your requirements.

For Transmitting Equipment that's good looking, dependable, rely on GATES.

Write or call for details about the GATES Priority System for Prompt Post-War Deliveries. GATES RADIO CO., Quincy, Ill.



PROGRESS REPORT

GATES is now in full production on civilian equipment and can make prompt delivery on many popular items.

GATES RADIO CO.
 New York Office
 40 Exchange Place
 Telephone: Hanover-2-0198
 QUINCY, ILLINOIS

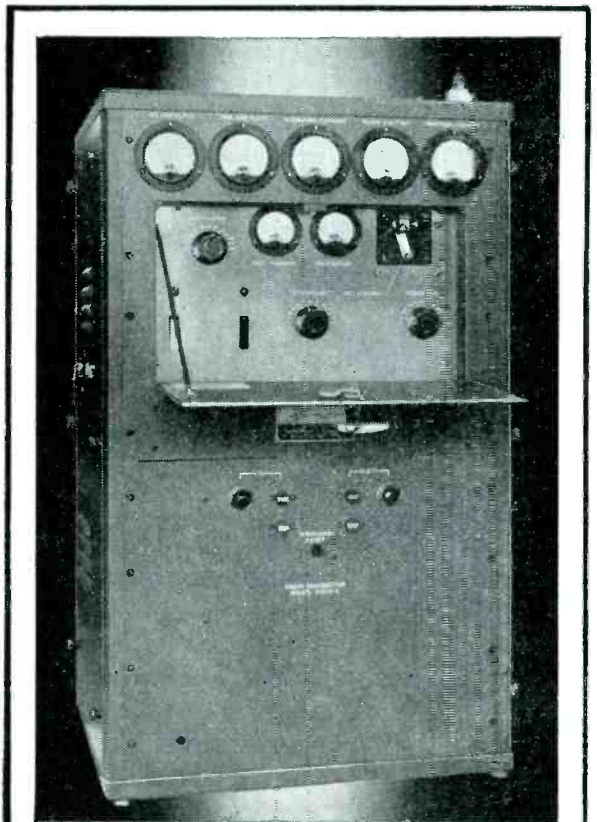

The New GATES Communications Transmitter
 FOR MILITARY • AERONAUTICAL • POINT TO POINT
 EMERGENCY • COASTAL HARBOR • RELAY BROADCAST
 FORESTRY • OTHER SERVICES

All of the features you are looking for are combined in this transmitter. You will find that it possesses Engineering, Reliability, Simplicity, Efficiency, and Serviceability—plus maximum Compactness. The tuning is preset at the factory, but quick, easy changes of operating frequency are possible. The Transmitter has complete metering and protective circuits, and features rapid frequency changes.

WRITE TODAY FOR DETAILED BULLETIN

EXCLUSIVE MANUFACTURERS OF RADIO TRANSMITTING EQUIPMENT SINCE 1922

FOR

**RADAR • RADIO • TELEVISION
INSTRUMENTS • BRIDGES
DECADE BOXES • TRANS-
FORMER TAPPING • PARALLELING
RESISTORS AND CAPACITORS
TAPPING INDUCTANCES
and dozens of similar
exacting uses**



Specially Engineered **SWITCHES**

in Special, Low Contact Resistance Designs

Shallcross Switches are a natural outgrowth of our own need for finely made, specially designed, low contact resistance units for a wide variety of exacting instrument and other applications. Solid silver contacts and contact arms assure highest conductivity, avoid danger from wear, and guard against corrosion. Up to 180 contacts can be supplied on a single switch. Single or multiple sections as required. Although many standard types are available, most switches supplied by us are special adaptations or unique designs to meet special needs. **WRITE!** Send today for technical literature on Shallcross switches. Put your problems up to Shallcross switch engineers for quick, economical, efficient solutions.

ANTI-MOISTURE ANTI-FUNGUS

Special treatment with materials to meet Signal Corps specifications available when required.

SHALLCROSS MFG. CO.

DEPT. E-125 , COLLINGDALE, PA.

ENGINEERING • DESIGNING • MANUFACTURING

the r-f and a-f tuned circuits are merely connected in series as shown in Fig. 1.

Measuring effective inductance of small r-f coils can be done if the wavemeter is set to a predetermined setting, say 1000 kc the coil clipped on and the dynatron turned to the wavemeter setting. The dial can be calibrated to indicate the inductance directly in microhenries. This can be done using standard inductances with interpolation between available values.

Using a good quality, 365- μ f capacitor, the 1000-kc setting would provide a scale of approximately 75 to 200 microhenries. A frequency of 1500 kc would provide a scale of 25 to 75 microhenries; 500 kc, the scale of 200 to 1000; and 250 kc, the scale of 1000 to 500 microhenries. This may be carried to as low a frequency as desired, provided the coils are of sufficient Q.

Measurement of inductance in the a-f range may be obtained by providing the wavemeter with a resonant audio circuit and a small capacitive coupling to the grid of the wavemeter. A capacitor decade box is also useful. Using this as the variable capacitor, the coil is tuned to the wavemeter frequency. The amount of capacitance in the circuit may be charted to indicate inductance.

Greater Accuracy

A method for acquiring a more accurate reading of inductances may be worked out by computing changes of capacitance against changes in frequency. These measurements may be carried well into the high-frequency bands but here the value of the tube as a dynatron becomes critical.

Mica and paper capacitors may be measured in conjunction with a known inductance. The frequency of oscillation, when the capacitor is inserted, indicates the capacitance when calculated against the known inductance. Leakage or resistive losses will be indicated by the lower Q as compared to that when a good capacitor is used.

Resistance of Chokes

In testing r-f chokes, it is useful to provide a parallel resonant cir-



INSTRUCTION NO. 1:-

“How to Eliminate a BOTTLENECK!”

When we went to war the conversion process was full of bottlenecks. And as we RE-convert to consumer production it's again a case of bottlenecks!

And the similarity goes still further. There will be certain parts or assemblies that will not be ready when the rest of the assemblies are completed. It will take time to finish up the war orders still in certain departments and get them switched over and tooled-up.

Sub-Contracting Is the Answer

America utilized the principle of sub-contracting when it went to war . . . and a production record resulted. American industry can utilize the same principle in RE-converting to peacetime products.

Why not isolate those parts on which you expect delay, and turn them over to a good sub-contractor. True, sub-contracting is one

of the toughest assignments in all industry. A good sub-contractor must have a different kind of team work . . . ingenuity . . . and timing with the other fellows operation.

But here at Lewyt we've been at it for over fifty years, making our production lines dove-tail with the assembly lines in other manufacturers' plants.

A Short-Cut To Having Those Consumer Products Ready

Why not give your salesmen a break and have your products ready ahead of the other fellow? At any rate it won't cost you anything to investigate why some of America's leading industries have decided it is a good policy to "let Lewyt do it".



Write on your business stationery for 48-page book, "Let Lewyt Do It"—the story of the Lewyt organization in pictures. Lewyt Corporation, 62 Broadway, Brooklyn 11, N. Y.



FOR MORE THAN 50 YEARS A CONTRACT MANUFACTURER . . . EXPERTLY STAFFED TO PRODUCE COMPLETE ELECTRONIC AND MECHANICAL ASSEMBLIES, COMPONENT PARTS, SUB-ASSEMBLIES AND METAL PRODUCTS, TO THE MOST EXACTING REQUIREMENTS

BUY VICTORY BONDS

Thanks!

- TO YOU!



Yes... thanks to all of you whose cooperation during the past ten years has helped us to grow and expand. As a result of your faith in our ability to engineer and manufacture according to your most exacting requirements, we can celebrate our tenth anniversary. In these ten short years, it has been our pleasure to work with many of the leaders in the various electronic and communication fields.

Airborne Instruments Laboratory, Inc.
Aireon Manufacturing Corporation
Brush Development Company
Civil Aeronautics Administration
Columbia Broadcasting System, Inc.
Gates Radio Company
Northwest Airlines, Inc.

Presto Recording Corporation
Radio Corporation of America
Schuttig & Company
Sylvania Electric Products Inc.
University of Minnesota
Western Union Telegraph Co.
Wilcox-Gay Corporation

are a few of the many friends to whom we say...

... thanks again!



Audio Development Co.
2833 13th Ave. S., Minneapolis, Minn.
"Audio Develops the Finest"

cuit. A frequency is chosen, say 500 kc, and the coil is made to tune to this frequency with approximately $\frac{1}{3}$ of the plate area of the tuning capacitor meshed. This point on the dial should be marked zero. If the choke is then clipped across the tuned circuit, the frequency will be altered. The capacitor is then increased until 500 kc is again obtained. This point on the dial can be calibrated to show the value of the added inductance of the choke.

When the choke is shunted across the circuit it will probably stop oscillating. It is necessary to lower the control-grid bias to reestablish oscillation. This will indicate a lower dynamic resistance the value of which will be that of the two coils in parallel.

When the dynamic resistance of the coil alone is known, that of the choke may be computed. Or, different values of resistance may be shunted across the tuned circuit in place of the chokes. The value of resistance that requires the same setting of the control-grid potentiometer to produce oscillation will be equal to the effective resistance of the choke.

The instrument may also be used for matching coils using a fixed, standard capacitor and for comparing properties of insulating materials.

Operating Conditions

With the circuit shown, the plate voltage may be between 25 and 75 volts. Maximum efficiency is obtained by increasing the negative grid bias until oscillation just ceases, then oscillation is reestablished by varying the plate voltage. This operation should be repeated until an optimum condition is found.

Another method is to adjust the bias to a slightly negative value, then shunt the oscillating circuit with decreasing values of resistance until oscillations cease; then reestablished, as before by varying the plate voltage. This operation should also be repeated to optimum conditions. The plate voltage should then be fixed and not varied after the control-grid potentiometer is calibrated.



ROD

... by REVERE

Revere NOW offers rod in a wide variety of alloys and the following shapes: round, hexagonal, octagonal, square, special. The physical characteristics of this rod vary with the alloy of which it is made, and the nature of our processing of it. Thus we can furnish you with rod suitable for practically any fabrication process and end use.

We offer Revere rod in the following:

Copper	Manganese Bronze
Free-Cutting Copper	Herculoy
Free-Cutting Brass	(Silicon Bronze)
Brass (not free-cutting)	Aluminum Bronze
Red-Brass	Aluminum-Silicon Bronze
Naval Brass	Nickel Silver
Muntz Metal	Magnesium Alloys
Commercial Bronze	Aluminum Alloys
Roman Bronze	Special Alloys

Available in coils or straight lengths, depending on size and composition. For full details, prices and deliveries, consult your Revere Distributor or us. The Revere Technical Advisory Service will gladly work with you in selecting the rod best fitted for your needs. For this assistance, which is given without obligation, just write the nearest Revere Office.

REVERE

COPPER AND BRASS INCORPORATED

Founded by Paul Revere in 1801

Executive Offices: 230 Park Ave., New York 17, N.Y.

Mills: Baltimore, Md.; Chicago, Ill.; Detroit, Mich.;
New Bedford, Mass.; Rome, N. Y.—Sales Offices in
principal cities, Distributors everywhere

*Listen to Exploring the Unknown on the Mutual
Network every Sunday evening, 9 to 9:30 p. m., E.S.T.*

THE ELECTRON ART

Sensitive Television Camera Tube.....	330
Non-ferrous Magnetometer	330
High-Frequency Deflection System.....	332
Microanalytic Measurement of Oxygen Production.....	340
Low Frequency Multivibrators.....	350
Modulation by Feedback.....	360

Sensitive Television Camera Tube

THE IMAGE ORTHICON, pushed during the war from the developmental stage into practicality by the Radio Corporation of America, has such high sensitivity in converting the optical image into electrical impulses that it simplifies the lighting problems of producing television programs. In addition, the image orthicon makes it possible to obtain clearer television images under shifting light conditions than is possible with earlier pick-up

oxide from which it derives its chromatic-sensitivity characteristic. This photosensitive surface emits electrons in proportion to the photons falling on it. In effect, the surface converts incident photons into impelled electrons. These derivative electrons are translated by a magnetic field through the mosaic screen, which can be of any producible fineness, to the scanning plate. By requiring the photosensitive element to perform but one function,

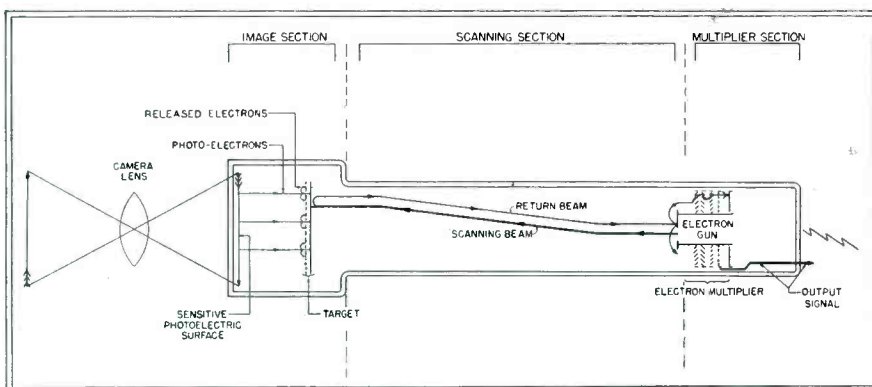

Image orthicon separates functions of photoelectric image conversion and scanning, and incorporates an amplifier

tubes. This new tube is portable as well, making it suitable for field pickups. The tube itself is 15 inches long and three inches in diameter at its widest section.

Operating Principle

As can be seen from the accompanying diagram, the image orthicon separates the functions of converting a light image into an electrical image, and of scanning the image. Because of this division of functions, each element can be designed for optimum performance thus giving maximum sensitivity.

The photosensitive surface which converts the optical image into an electrical image is chiefly cesium

its sensitivity is increased several times over that of the Iconoscope because full utilization can be made of its photosensitive properties.

The scanning target is a semiconductor. The focused, derivative electrons that reach it set up charges. Because electrons are constantly reaching the scanning target, 100-percent image storage is obtained in this fundamentally orthicon-type tube. The target is scanned by a magnetically controlled beam. The target itself is at the same potential as the beam cathode, thus where the target has become charged from the image electrons, it reflects the electrons of the scanning beam in proportion to

the image intensity. These reflected electrons are returned to a pick-up, annular-ring dynode surrounding the cathode. The conductivity and thickness of the semi-conductive scanning target are the chief parameters that determine its efficiency.

The reflected electron stream is amplified in a cascade electron multiplier of variable gain. This automatically variable gain feature is such that at low levels the gain is high and at high levels it is low. The action prevents intense light from obliterating the entire image as in some earlier type tubes.

The over-all system has almost unity gamma and is operative in scenes illuminated with as low as 0.01 candles per square foot. The gain of the multiplier is about 100 at the 0.01 candle level, and decreases to about 10 at a 10 candle level. By placing an amplifier in the tube the image signal is amplified above the noise level before it is placed on outside conductors where interference will be picked up.

Non-Ferrous Magnetometer

A MERCURY JET MAGNETOMETER for measurement of magnetic field intensities in sharply localized regions is described by Alexander Kolin in the *Review of Scientific Instruments* for August 1945. Operation depends on potential being induced in a moving conductor placed in the magnetic field; the moving conductor in this case is a flowing stream of mercury.

The search channel consists of a narrow non-conducting tube carrying mercury at constant velocity. Two electrodes, at ends of a tube diameter, pick off the emf developed by the moving conductor (mercury) in the magnetic field under study. A ratio of 10 to 1 between channel length and diameter (0.2 mm by 2 mm) has been found satisfactory.

Induced emf is given by $e = \mu Hdv \times 10^{-8}$ volt, where d is the separation of electrodes (diameter of the tube), v is the average velocity of mercury flow (regardless of velocity distribution), and H in oersteds is the component of local magnetic field mutually perpendicular to the channel axis and the elec-

OVER A THOUSAND DIFFERENT

STOCK Rheostats, Resistors, Tap Switches

AT

OHMITE

*Offers a Quick Answer to
Resistance Control Needs*



Send for Stock-Unit
Catalog No. 18
Write for this quick, help-
ful reference. Gives valu-
able data and information
on the wide variety of
Ohmite Stock Units

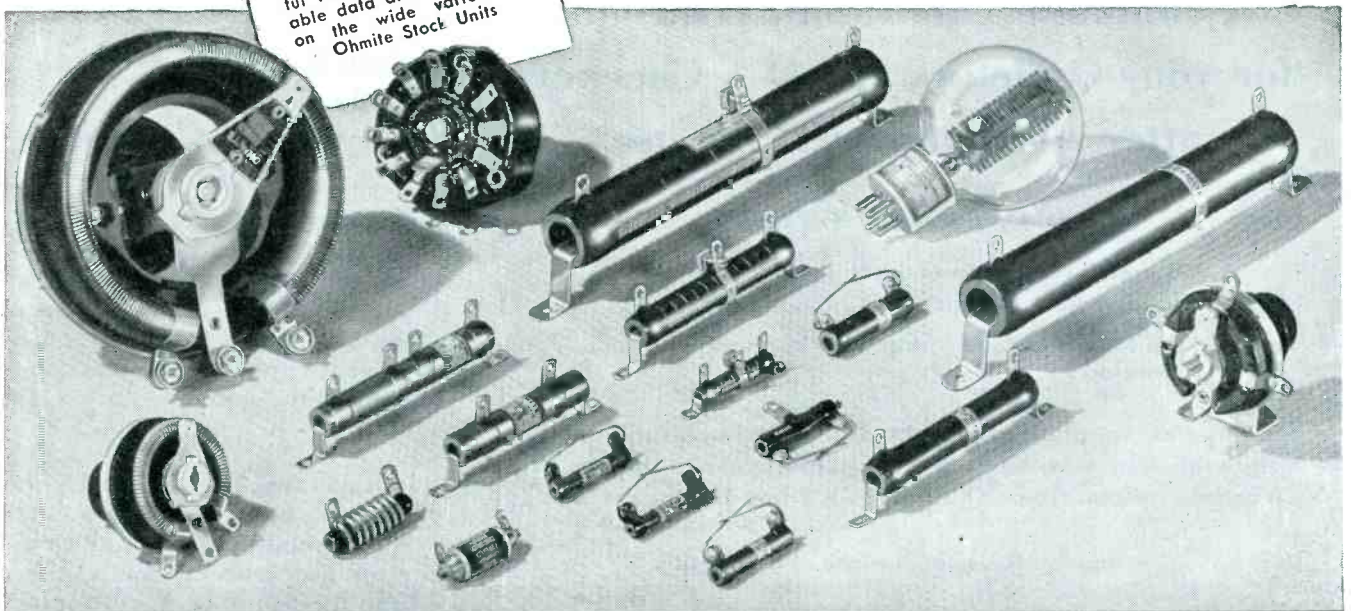

THE Ohmite stock of power rheostats, resistors and tap switches is the largest and most complete in existence . . . in variety and number!

Stock model rheostats are available in six different sizes from 25 to 500 watts . . . each size carried in more than a score of different resistance values . . . some as low as 0.5 ohm and others as high as 10,000 ohms.

Among the stock resistors are eight sizes of wire-wound fixed resistors rated at 1, 10, 20, 25, 50, 100, 160 and 200 watts. Also seven sizes of "Dividohm" adjustable resistors rated at 10, 25, 50, 75, 100, 160 and 200 watts. All sizes are available in scores of resistance values, some less than 1 ohm, others as high as 250,000 ohms.

There are also three series of stock tapped resistors (ten-section "Multivolts"), three series of non-inductive resistors, two series of glass-enclosed non-inductive resistors, five series of "Riteohm" precision resistors, seven series of tap switches, nine series of radio frequency chokes, and many other units.

So great is the variety of Ohmite stock units that a combination of them can be used to obtain an endless number of resistances and wattage capacities. Special units engineered and produced to your specifications.

OHMITE MANUFACTURING COMPANY
4818 FLOURNOY STREET, CHICAGO 44, U. S. A.

Be Right with **OHMITE**

RHEOSTATS • RESISTORS • TAP SWITCHES

Now! Q SERVICE

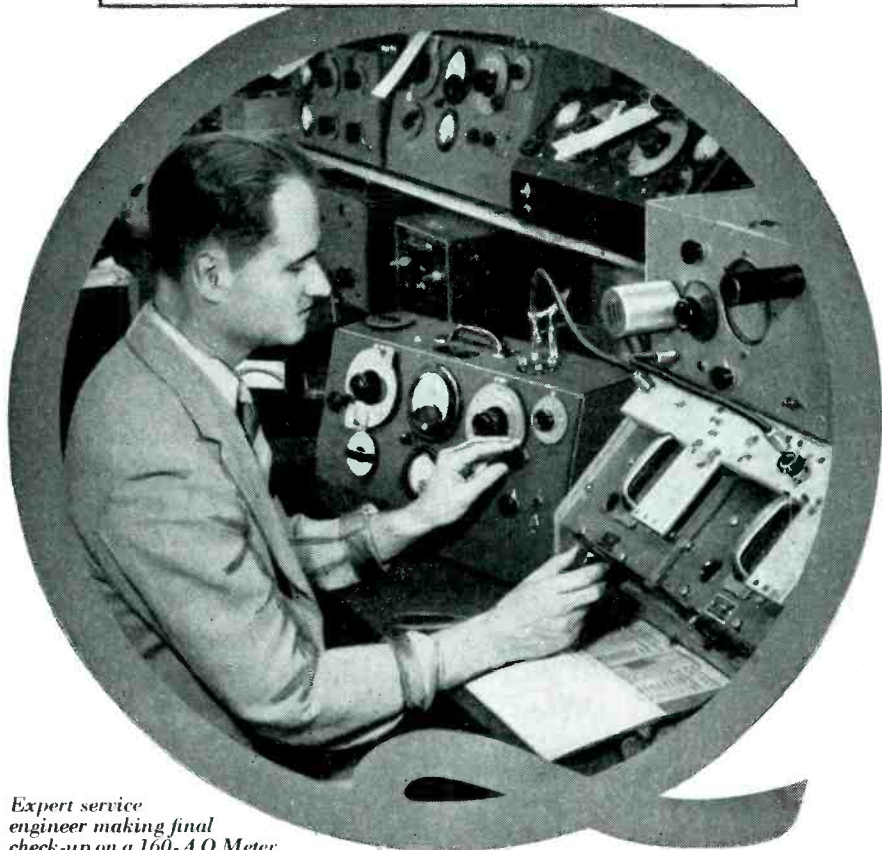

Expert service engineer making final check-up on a 160-A Q Meter

A complete Laboratory Overhaul for your Q Meters and Q-X Checkers after strenuous wartime use.

"Q SERVICE" includes

1. General Check and Clean-up of the instrument.
2. Complete Re-calibration in our Standards Department.
3. Loan of a replacement while your instrument is in our Laboratory.

In answer to many requests and in recognition of the unusual demands made on your instruments during the Wartime years, this "Q SERVICE" has been developed.

For complete information write to Department E



BOONTON RADIO

BOONTON, N. J.

Corporation



DESIGNERS AND MANUFACTURERS OF THE "Q" METER . . . QX-CHECKER . . . FREQUENCY MODULATED SIGNAL GENERATOR . . . BEAT FREQUENCY GENERATOR . . . AND OTHER DIRECT READING TEST INSTRUMENTS

trode diameter. Orientation of the magnetic field can be determined by locating the channel probe in the position that gives a maximum voltage, then flux direction can be determined from the above perpendicularity relation.

The electrodes are connected to a millivoltmeter. Induced emf, mercury velocity and channel diameter can be measured accurately with readily available instruments, thus H can be determined with high precision. The instrument can make continuous field measurements, and is therefore valuable in transient field measurements.

In the equipment as developed for laboratory measurements, a magnetometer with permanent magnet is used as flow meter. The sensitivity of the flow-meter magnetometer is adjusted by rotating the permanent magnet; the cosine of the magnetic angle giving the multiplying factor.

The same principle is used for the mercury pump. Electrodes are made to pass current through the entire cross section of the mercury path. A permanent magnet provides flux over the same volume. Control of the electrode current governs the mercury flow.

• • •

High-Frequency Deflection System

By GUNTHER RUDENBERG

Harvard University
From *Jour. of Applied Physics*, May 1945

THEORETICAL DESIGN considerations for the deflection system of a cathode ray tube to be used at high frequencies include the driving amplifier output, the sensitivity of the deflection system, and the arrangement of the system.

Amplifier

High-frequency characteristics of wide-band oscilloscopes are chiefly limited by the amplifier stage that drive the deflection system. A figure of merit for this stage is $I/C = E \omega'$ where I is the maximum output current from the stage, which can be approximated by the average current drawn by the tube for class A operation, and C is the total shunt capacitance in-

PLASTIC PARTS

... PRODUCED TO YOUR SPECIFICATIONS

PRINTING DIE CUTTING CEMENTING

Wide experience by all known processes in the application of printing, engraving, silk screening, die cutting and cementing of all thermoplastics.

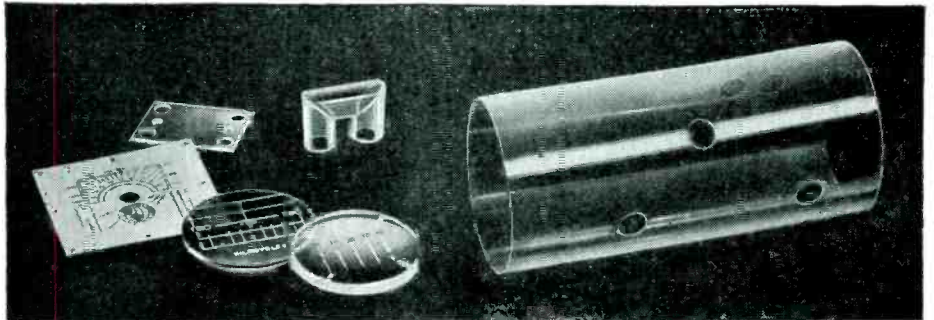

FORMING

Specialists in deep drawing radio dial windows, embossing, swaging and bending in Acetate, Vinylite and Acrylics.

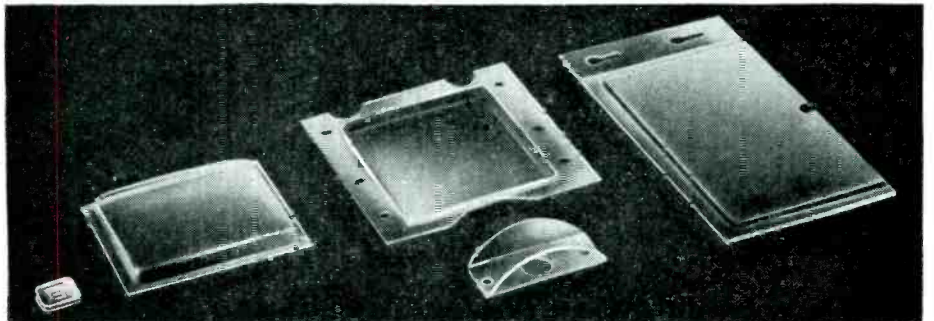

MACHINING

Precision threading, screw machine, milling, drilling, turning of Polystyrene, Acrylics, Phenolics, Nylon, Tenite; sheets, tubes and rods; through spindle capacity up to 2½" rod.

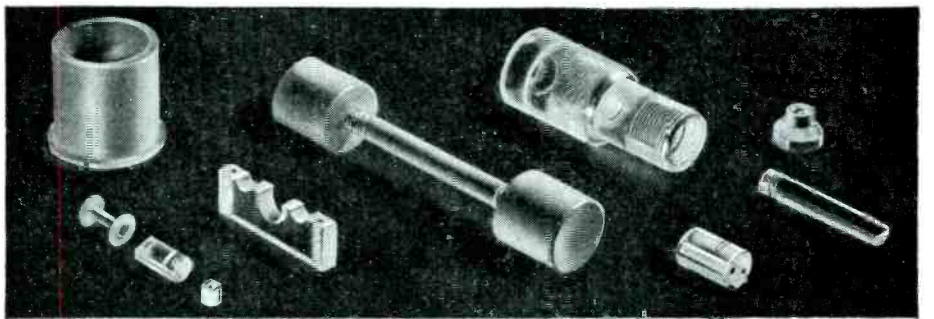

ASSEMBLY

Our engineers can assist you in problems of design and assembly of your plastic units.

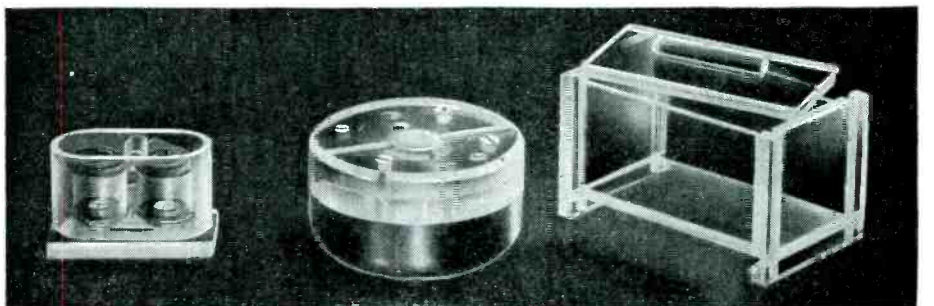

PRINTLOID, Inc.

93 Mercer Street
New York 12, N. Y.

IF ONLY I HAD USED **CAPACITRONS**
IN MY FLUORESCENT
BALLASTS!



You Too Will Want the Dependability of CAPACITRONS to Keep Your Ballasts on the Job at Extreme Temperatures

Capacitron fluorescent ballast capacitors are the result of one of the most extensive research projects ever conducted.

Continuous laboratory work, carried on for over two years in conjunction with actual field tests involving operational reports on over 20,000 service units, has proved the ability of Capacitrons to remain on the job when ordinary capacitors fail.

Capacitrons will put an end to your fluorescent ballast capacitor worries and at the same time provide the assurance of adequate deliveries to meet increased production requirements. Why not let us work with you now?

**IMMEDIATE
DELIVERY!**

Telephone VAN Buren 3322

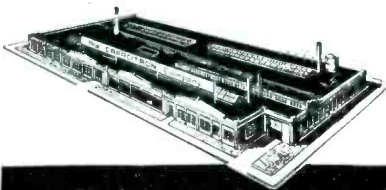

The CAPACITRON Company
849 North Kedzie Ave., Chicago 51, Illinois

cluding both that of the amplifier and of the deflection system, E is the peak output voltage, and ω' is the upper frequency limit of the amplifier; i.e., the half-power frequency.

From this figure of merit we see that to obtain high-frequency response, capacitance C should be made small. Also, the available a-c from the tube should be made large by either using tube and operating conditions which draw a large current or using negative feedback. Another possibility is to reduce the required E by increasing the sensitivity of the deflection system which may prove advantageous despite the accompanying increase in capacitance. For fixed-frequency operation, input and output of the amplifier can be tuned.

Deflection Sensitivity

If, for small transit times, the deflection field is uniform across its width, and the acceleration potential V with which the electron beam enters the deflection field is constant, the deflection angle θ of the beam produced by the deflection field is, from electron ballistics,

$$\theta = (1/2V) \int_{Z_1}^{Z_2} \epsilon dz \quad (1)$$

where Z_1 is the position of the beginning and Z_2 the ending of the deflection field as seen by the electron beam, and ϵ is the perpendicular component of the electric field along the path of the beam.

From Gauss's theorem applied to the plane of the path of the beam within the deflection field area, we obtain

$$\rho/\epsilon_0 = \int_{Z_1}^{Z_2} \epsilon dz \quad (2)$$

in which ρ is the charge per unit width of the plates and ϵ_0 is the permittivity of the space between the plates. If E is the voltage between the plates, and c is their capacitance per unit width related to that portion of the electrostatic field that the beam traverses, then

$$\theta = Ec/2V\epsilon_0 \quad (3)$$

This equation shows that, instead of the equivalent length of an idealized deflection system without fringing fields giving the same deflection as the actual system, it is a system having the same apparent capacitance per unit width that

For Eimac's

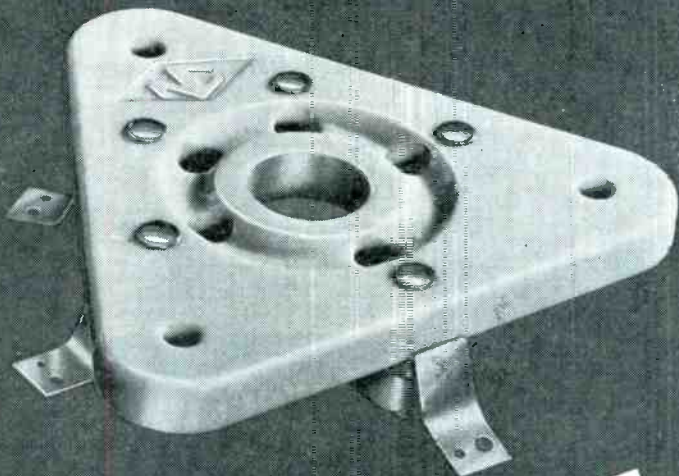

FOR EIMAC TETRODES 4-125-A, 4-250-A AND OTHERS

The HX-100 is a husky low-loss socket that will handle any tube using the "Giant" 5-pin base, including the Eimac 4-125-A and the Eimac 4-250-A. The HX-100 is of the wafer type with a low-loss ceramic body. Contacts are of the heavy duty type with auxiliary springs to provide ample contact pressure. In every detail, HX-100 is designed to contribute top performance through a long, trouble-free life.

Deliveries to dealers will begin about the time this issue appears.

HX-100 Socket List Price, \$3.30.

HX-100S Socket with three stand-off insulators, List Price, \$4.25.

NATIONAL COMPANY, INC.
MALDEN, MASS., U.S.A.



VERSATILE is the name
for this RUGGED TURNER mike

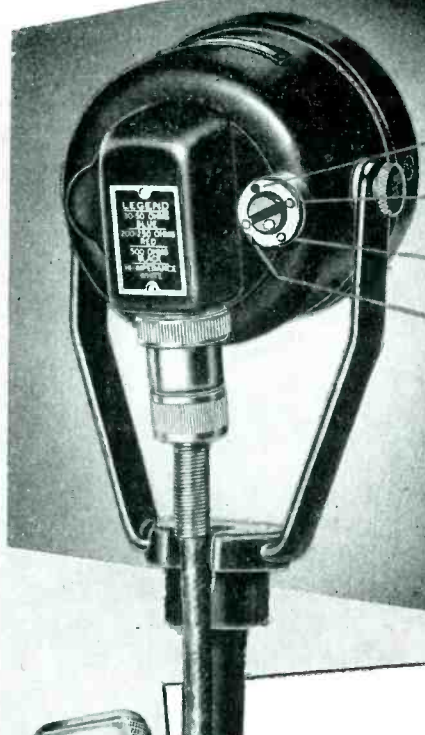

- 30-50 OHMS
- 200-250 OHMS
- 500 OHMS
- HIGH IMPEDANCE

**Turner
U9S**

**4 Impedance Requirements
at Your Fingertips**

A twist of the "selecto-switch" on the Turner U9S gives you a choice of 30-50, 200-250, 500 ohms or high-impedance to fill practically ANY impedance requirement. Removable cable feature permits quick cable changes and its adjustable saddle fits standard microphone stands and allows semi- or non-directional operation. Professional in both appearance and performance, the U9S is a precision instrument, ruggedly built to stand up and deliver under severe service conditions. It is widely used for commercial broadcast, P.A., and police communications work. Level -52DB at high-impedance with response free from peaks or holes from 40 to 9000 cycles. Gunmetal type finish. Complete with 20 ft. removable cable set. Ask your distributor or write.

Complete Turner Catalog describes fully all TURNER Microphones for general and specific applications. Write for your free copy.

THE TURNER COMPANY
 905 17TH ST. N. E., CEDAR RAPIDS, IOWA

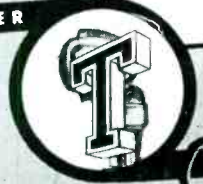
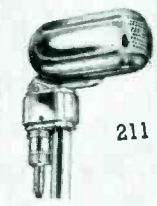

TURNER
 Pioneers in the communications field

Microphones

Crystals Licensed Under Patents of the Brush Development Co.

gives the same deflection. This capacitance takes into consideration the fringe effects in the path of the beam.

From Eq. 1 and 2 we find that $\theta = \rho/2V \epsilon_0$. This result shows that the deflection angle depends on the internal charge per unit width that can be placed on the system, and upon the axial accelerating potential, regardless of the configuration or potential of the deflecting system. The aims in designing either a deflection system or its amplifier are thus to decrease the

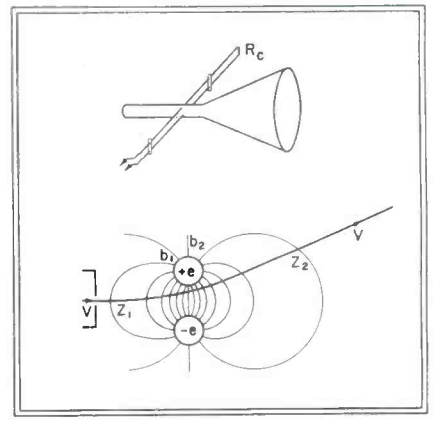

At the top is a parallel-wire line used as the deflection system of a cathode-ray tube. The line can be terminated in its characteristic resistance thereby giving a system having an impedance independent of frequency. At the bottom is the deflection field established by the line. The length of the field is comparable to the wire spacing

beam accelerating potential at the deflection system and to increase the internal charge per unit width of the system.

For a given total charge, the deflection angle can be increased by making c large compared to the total circuit capacitance. Instead of making the deflection plates as small as possible as has heretofore been suggested, they should be designed to have large capacitance especially if the cathode-ray tube is to be connected to an amplifier which has some capacitance and can supply only a limited charge for the deflection system.

Parallel-Wire Line for Deflection

The factor c/ϵ_0 in Eq. 3 is a dimensionless quantity. Thus once the shape of the deflection system has been determined, its sensitivity



SHEET

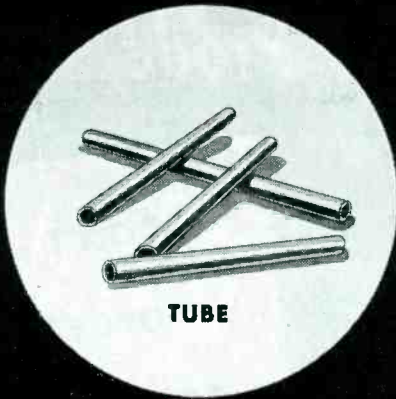

TUBE



WIRE

HERE MAY BE
The Solution

TO YOUR METAL PROBLEM...



LAMINATED CONTACT BUTTONS

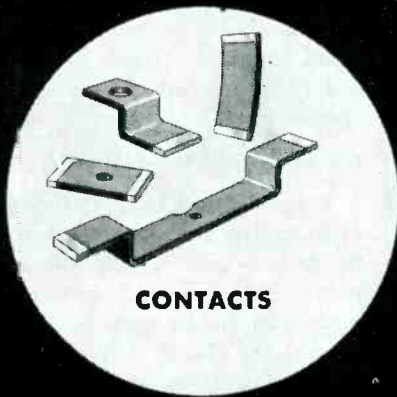

CONTACTS



INLAY METALS



THERMOSTAT METALS

General Plate Laminated Metals

General Plate Laminated Metals . . . permanently bonded combinations of precious metals to base metals or base to base metals . . . can provide the solution to your performance or design metal problems whether the product be a peanut radar tube, an electrical contact or a giant turbine.

These versatile laminated metals . . . in sheet, wire, tube—or as fabricated parts . . . give you high electrical performance, corrosion resistance, workability, mechanical and structural properties not found in single solid metals—and best of all, at a fraction of the cost of solid precious metals.

Investigate General Plate Laminated Metals today. Find out how their unusual performance and cost-cutting advantages can help increase production . . . improve your product . . . and save money, too.

Our engineers will gladly help you with your metal problems. Write for their services.

Check these General Plate advantages:

- Corrosion Resistance
- Ease of fabrication
- Ease of soldering
- Workability
- Long life
- Economy
- Electrical Performance

GENERAL PLATE DIVISION

of Metals & Controls Corporation

50 Church St., New York, N. Y.; 205 W. Wacker Drive, Chicago, Ill.; 2635 Page Drive, Altadena, California
 Grant Bldg., Rm. 603, Pittsburgh, Pa.

ATTLEBORO, MASSACHUSETTS

Designing a New Product?

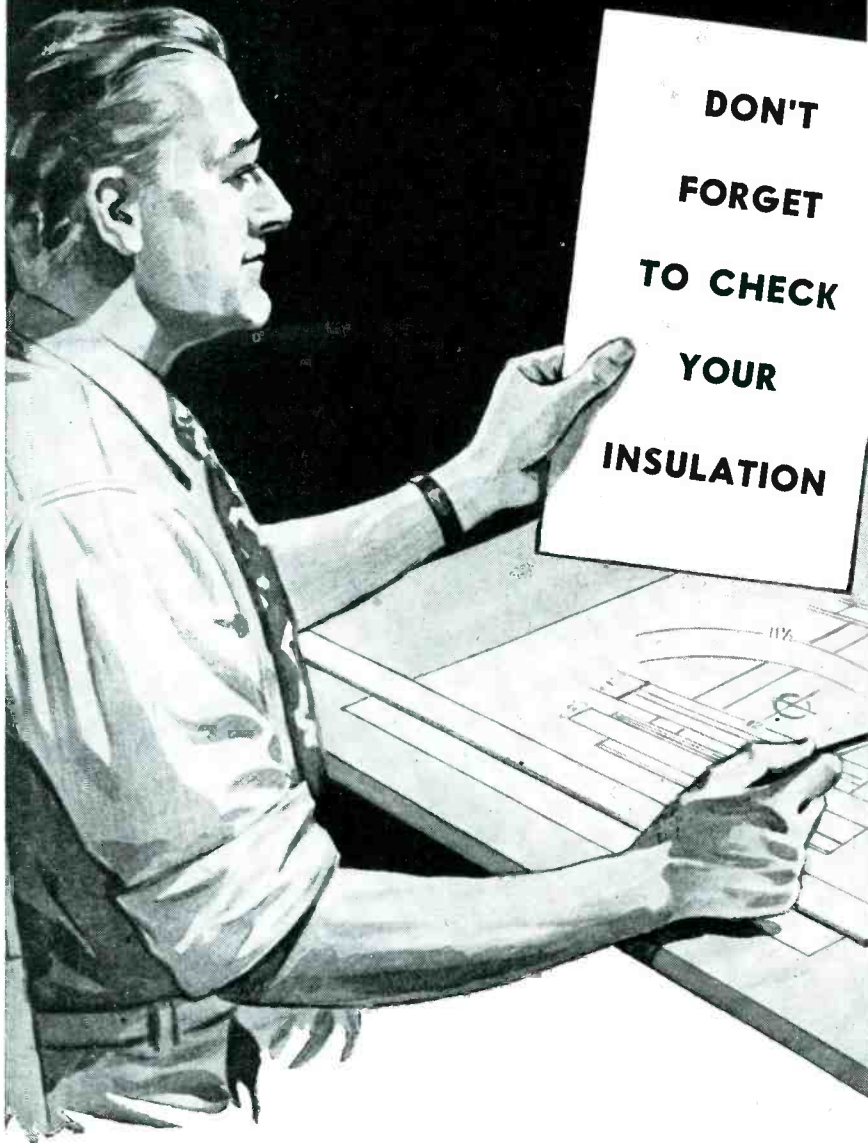

AMID the "hub-bub" of improvements, gadgets, streamlining, etc. we're likely to forget a few basic elements of customer satisfaction such as efficient insulation. When wise manufacturers think of insulation, they think of INSL-X coatings. INSL-X Research Leadership has made INSL-X foremost in quality.

Literature on Request

INSL-X
MEANS MODERN
INSULATION

THE INSL-X COMPANY INC.
857 MEEKER AVE., BROOKLYN 22, N. Y.
CHICAGO • DETROIT • LOS ANGELES • PHILADELPHIA
CLEVELAND • ST. LOUIS

—as long as transit-time effects do not enter—has been determined. However, because the axial length of deflection systems that use pairs of plates flared at their ends and the inductance and capacitance of their leads enter at high frequencies, the deflection is reduced.

Both transit time and lead effects can be reduced by using a closely spaced, parallel-wire line as illustrated in the accompanying figure. The capacitance per unit length of such a line is

$$c = \pi\epsilon_0 / \cosh^{-1}(d/2r)$$

where r is the radius of the wires and d is their spacing. From Eq. 3 their deflection is

$$\theta = \frac{E}{2V} \frac{\pi}{\cosh^{-1}(d/2r)} \approx \frac{E}{2V} \frac{\pi}{\ln(d/r)}$$

the approximation being valid for large (d/r) .

The electrostatic field is mainly concentrated within a distance equal to the wire spacing. Thus the significant part of the transit time is that time required for the beam to cross a space of the same order of magnitude as the wire spacing.

Use of Parallel-Wire Deflection System

For measurements at fixed, high frequencies the parallel wires can be tuned, and by proper adjustment of the tuning a voltage maximum can be located at the point where the beam travels between them. Owing to the low losses of such a line, very high maximum of charge and voltage can be obtained thus ensuring a maximum deflection.

For wide-band operation, the deflection system should be terminated in its characteristic impedance. A greater power input to the deflection system than for the tuned condition will be required, but the system will present a pure resistance load at all frequencies. The surge resistance of a nonresonant line is

$$R_c = 120 \cosh^{-1}(d/2r) \text{ ohms}$$

Thus the deflection angle in terms of the input current $I = E/R_c$ to the line is

$$\theta = 60 \pi I / V$$

We see that this deflection is independent of the relative line spacing and is primarily determined by the

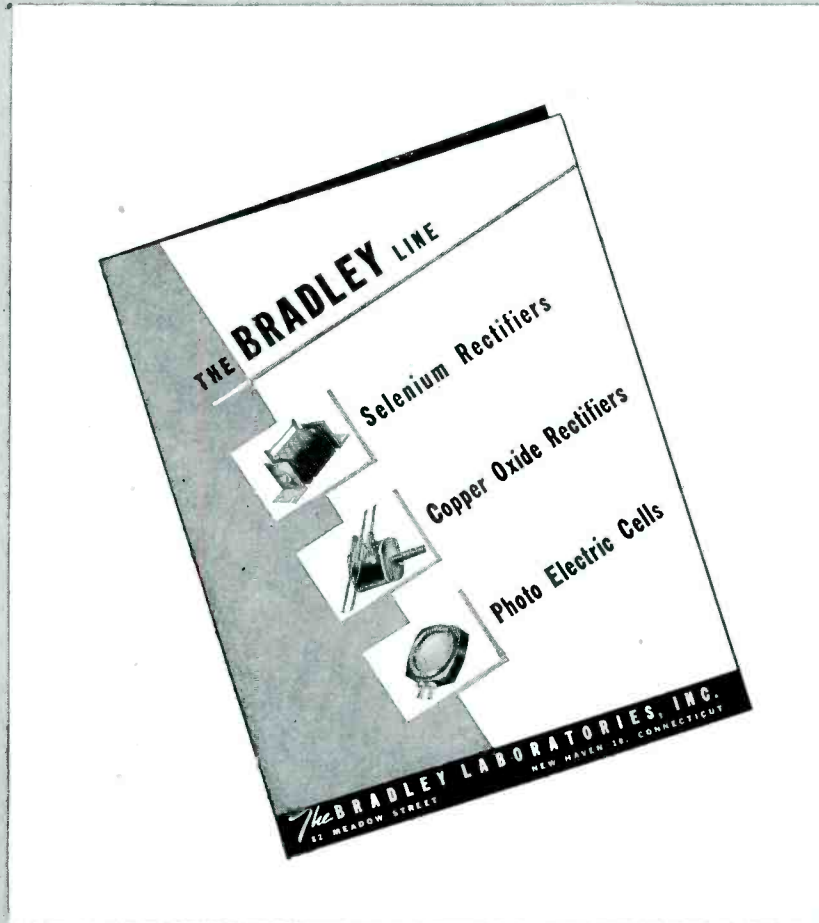

*Write for your copy of
this new literature-*

BRADLEY
LABORATORIES, INC.
82 MEADOW ST., NEW HAVEN 10, CONN.

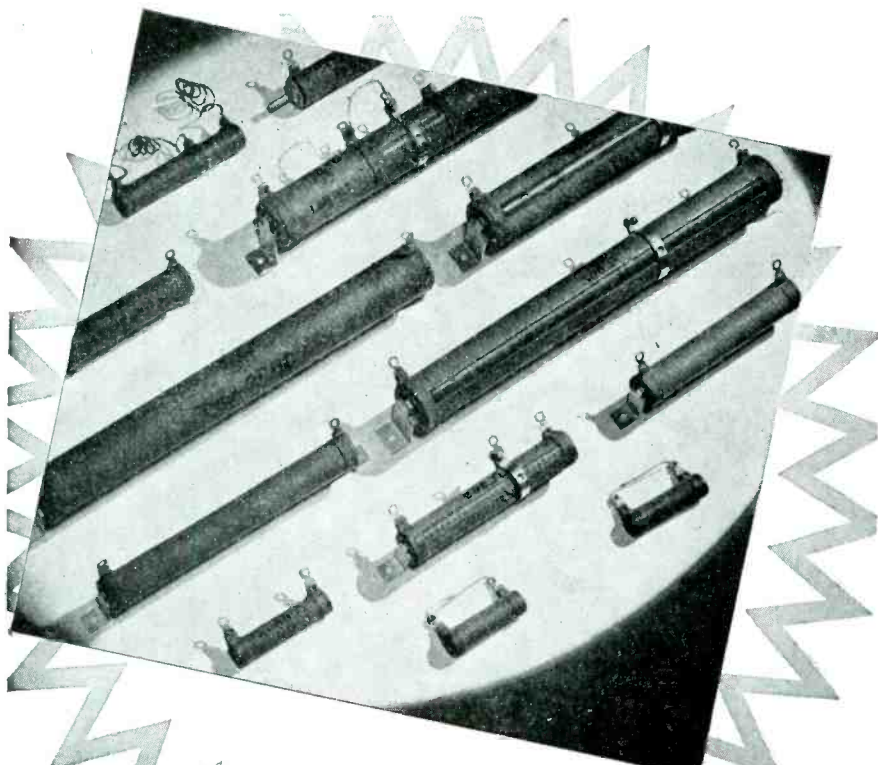

GREENOHMS



Products of
"THE HOUSE OF RESISTORS"

Standard 10 and 20 watt fixed resistors. 1-50,000 and 1-100,000 ohms.

Standard adjustable resistors. 25 to 200 watts. 1-100,000 ohms. Brackets furnished. Additional sliders available.

Greenohms feature the exclusive Clarostat cold-setting inorganic cement coating. Won't flake, peel, crack, even under serious overload.

Greenohms can take an awful beating. Handle heavy overloads without flinching.

Available in widest range of windings, terminals, mountings, taps, etc. on special order.

★ GREENOHMS—those green-colored cement-coated Clarostat power resistors—definitely "stay put." You can positively bank on their resistance value. Proof? The fact that they are now found in the finest assemblies—quality instruments, radio transmitters, electronic equipment. The resistance is *right* to start with. And it stays *right* even after years of use and abuse.

Recently we had occasion to check a batch of Greenohms that had been lying around in a warehouse for years—part of one of our radio show displays. Each and every Greenohm checked "right on the nose." And they make out even better in use and under real abuse.

★ Submit Your Problem . . .

Tell us about your resistance or control problem. Let us provide engineering collaboration, specifications, quotations.

CLAROSTAT



Controls and Resistors

CLAROSTAT MFG. CO., Inc. · 285-7 N. 6th St., Brooklyn, N. Y.

current or charge on the deflection system.

The driving power for the non-resonant system is mainly dissipated in the terminating resistance and will be least when that resistance is smallest. This requirement indicates thick wires closely spaced. Where the wire diameter is too thick to be sealed into the glass walls of the cathode-ray tube, their cross section can be reduced thus offsetting the effect of the added dielectric of the glass on the characteristic impedance.

Contrasted to the conventional deflection-plate system in which a reactive power proportional to frequency is required, the parallel-wire system requires a resistive power that is independent of frequency. In the study of transients this advantage plus the absence of resonances make the parallel-wire deflection system very useful. If closely spaced wires are used, the low transit time enables absolute voltage measurements to be made at high frequencies.

• • •

Microanalytic Measurement of Oxygen Production

By PETER PRINGSHEIM
*Ray Control Company
Pasadena, California*

A METHOD FOR MEASURING the production of very small quantities of oxygen has been developed in collaboration with J. Franck and Dolores Terwood in the laboratory of the Fels Foundation in the Department of Chemistry of the University of Chicago.¹ The method is based on a phenomenon discovered by Kautsky² and permits measuring quantitatively the production of 10^{-6} cc per second of O_2 at atmospheric pressure.

Preparation of Phosphor

Kautsky found that if a dye such as tryptoflavine (acriflavine) is absorbed on silica gel and the gel is highly evacuated, the dye becomes phosphorescent when irradiated with light from an incandescent lamp, the afterglow being visible for about 10 seconds after the end of the irradiation. This phosphorescence is not affected by the presence of very pure N_2 , H_2 , CO_2 , CO

METAL ASSEMBLIES AND COMPONENTS FOR ELECTRONIC AND MECHANICAL DEVICES

●
ENGINEERING

●
DEVELOPING

●
FABRICATING

●
ELECTRO-FORMING

●
PLATING

●
FINISHING
●

BERNARD **R**ICE'S **S**ONS

I N C O R P O R A T E D

MANUFACTURERS OF QUALITY METAL PRODUCTS SINCE 1867

OFFICE: 325 FIFTH AVENUE, NEW YORK 16, N. Y.

WORKS: 139-145 NORTH TENTH STREET, BROOKLYN 11, N. Y.

OHIO

MOTORS for ELECTRONIC APPLICATIONS

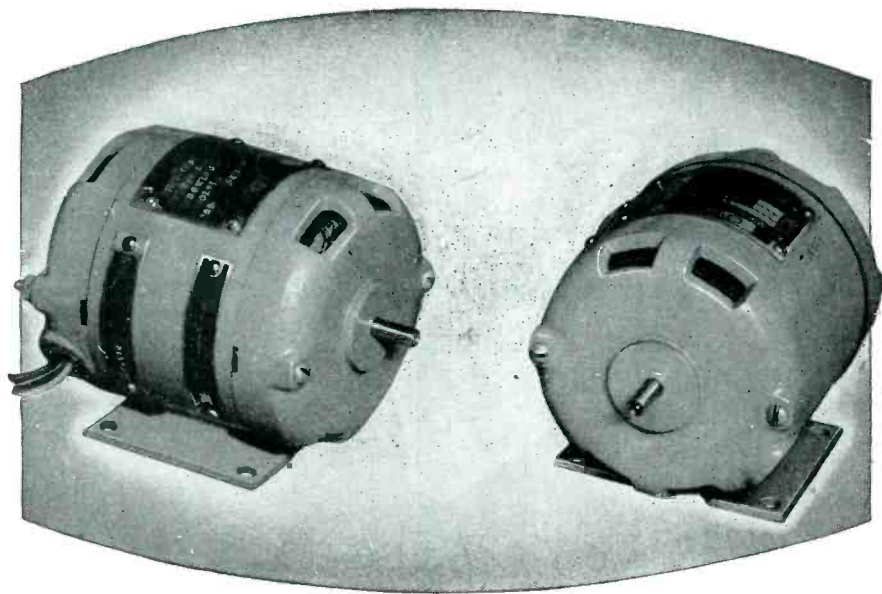

1/75 HP.—115 V-60 Cy.—1 Ph. 1670 R. P. M.—Clockwise, Ball Bearing, Ventilated.

Cut shows one of many types and sizes of Ohio Motors designed for driving Electronic Devices.

RANGE

- 1/100 to 2 HP.—A.C.
- 1/100 to 1 HP.—D.C.
- 1/100 to 1/4 HP.—A.C. Synchronous,
- 1 to 100 oz. ft. A.C. Torque.
- Shell type motors for built-in applications to 4 HP.—D.C. and to 7 1/2 HP.—A.C.
- All usual voltages and cycles.

What is your problem?

THE OHIO ELECTRIC MANUFACTURING CO.
5908 Maurice Avenue Cleveland 4, Ohio

or a rare gas, but it is very strongly quenched by the presence of the smallest quantities of O_2 .

The phosphor, the phosphorescent gel with adsorbed dye, is prepared by immersing carefully purified silica gel in a dilute aqueous solution (0.5 normal) of the dye during a period of a few hours, keeping the solution in the dark. The grains of the gel should have a diameter of about 1 mm. After being dried superficially, a small quantity of the phosphor is inserted into a glass tube and evacuated during several hours to the highest attainable vacuum, while it is heated to $350^\circ C$. From there on, the phosphor must be protected against contamination with oxygen at high pressure. If it should come into contact with atmospheric air, the high temperature, vacuum treatment must be repeated.

Phosphoroscope

For quantitative measurements the tube containing the phosphor is placed between the discs of a Becquerel phosphoroscope the arrangement of which is shown in Fig. 1. The phosphor fills a tube of 4 mm

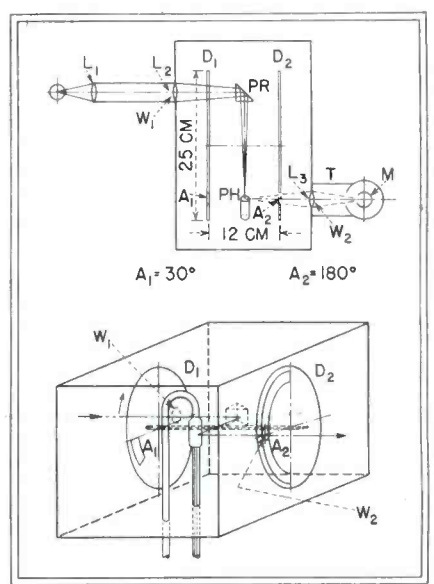

Fig. 1—Phosphoroscope in which oxygen sensitive phosphorescent dye is illuminated, the illumination shut off, and the reradiation directed to a photo tube

inner diameter and a length of 20 mm and is held in position by nickel gauze.

Exciting light enters the box of

MORE FACTS ABOUT THE "VT FUZE"

"the secret weapon second only to the Atomic Bomb"

...and its 17 Metal Electrōnents mass-produced by Scovill*



Scovill was one of the first subcontractors to get into mass production on the "VT Fuze" metal components illustrated below. Four of the many problems involved in producing these tricky metal parts in large volume to extremely close tolerances and other difficult specifications will interest you.

Part 1, the "potato masher" required extraordinary redrawing of stamped shells. Scovill installed and developed many special machines to meet the urgent production schedules.

Part 2, the detonator disc . . . held to tolerances of less than .001".

Part 3, the antenna insert . . . an irregularly shaped drawn shell, made hollow instead of solid to save weight.

Part 4, the wind-driven vane which rotates the generator at 100,000 RPM . . . held to 1° concentricity.

Similarly, all the other parts had unusual specifications which called for the ingenuity of 15 different Scovill production departments in applying and improvising metal-working techniques . . . a well-known characteristic of Scovill engineers. For up-to-the-minute facts about how Scovill can save time and money on your small electronic components or complete assemblies, use the coupon below—today.

*Electrōnents = Electronic Components.

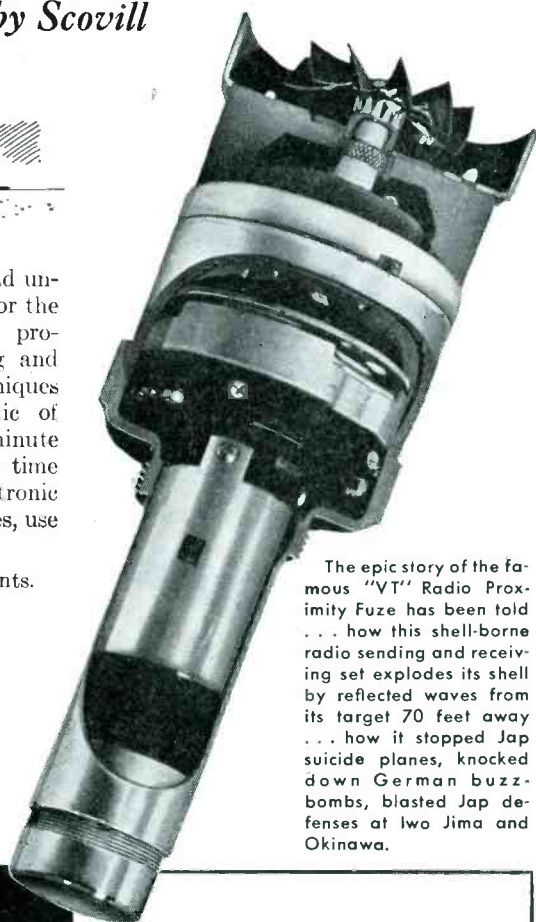

The epic story of the famous "VT" Radio Proximity Fuze has been told . . . how this shell-borne radio sending and receiving set explodes its shell by reflected waves from its target 70 feet away . . . how it stopped Jap suicide planes, knocked down German buzz-bombs, blasted Jap defenses at Iwo Jima and Okinawa.



1. "Potato masher" encasing can
2. "T" cup disc
3. antenna insert
4. vane
5. spray shield
6. chassis plate assemblies
7. condenser cans
8. "T" cup
9. contact
10. control cover
11. coupling
12. chassis cover
13. condenser cover
14. vane shield

Please send me a free copy of "Masters of Metal" booklet describing your facilities. I am interested in the ELECTRONENT* applications checked.

- | | | |
|--|--------------------------------------|--|
| <input type="checkbox"/> Batteries | <input type="checkbox"/> Dials | <input type="checkbox"/> Panels |
| <input type="checkbox"/> Record Changers | <input type="checkbox"/> Escutcheons | <input type="checkbox"/> Sockets |
| <input type="checkbox"/> Clips | <input type="checkbox"/> Jacks | <input type="checkbox"/> Stampings (misc.) |
| <input type="checkbox"/> Condensers | <input type="checkbox"/> Lugs | <input type="checkbox"/> Tubes |

Other applications.....

SCOVILL MANUFACTURING COMPANY

Electronic Division*
22 Mill Street
Waterbury 91, Connecticut

Name

Company

Address

THE ART OF ACCURACY

QUAKER CITY CRAFTSMEN, USING THE MOST

MODERN MACHINES PRODUCE PRECISION GROUND

FORM WORMS ... OUR RIGID STANDARDS ARE NOW

MEETING EXACTING DEMANDS OF THE ELECTRONICS

INDUSTRY ... YOUR INQUIRY WILL BE APPRECIATED

AND WILL BE GIVEN PROMPT ATTENTION.

QUAKER CITY GEAR WORKS, INC.
 1918 NORTH FRONT ST.
 PHILADELPHIA 22, PENNA.

the phosphoroscope through a window W_1 and the aperture A_1 in the first rotating disk D_1 ; the phosphorescent light is transmitted through window W_2 and aperture A_2 in the second rotating disk D_2 . Apertures A_1 and A_2 are adjusted so that W_1 is completely screened by D_1 before A_2 opens window W_2 . No light can fall on the phosphor except the radiation transmitted through W_1 and A_1 .

The phosphor is excited by the radiation of a General Electric Mazda Projection lamp (6 v, 18 a) the current of which is supplied by a transformer connected to the house line through a voltage regulator. The light is made parallel by a lens L_1 of small focal length so

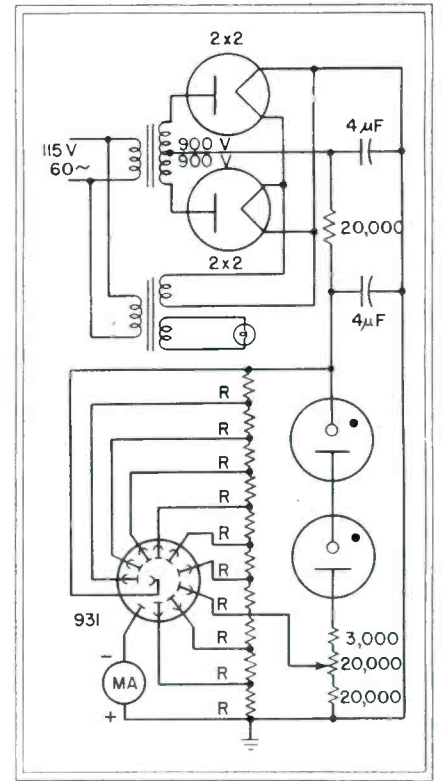
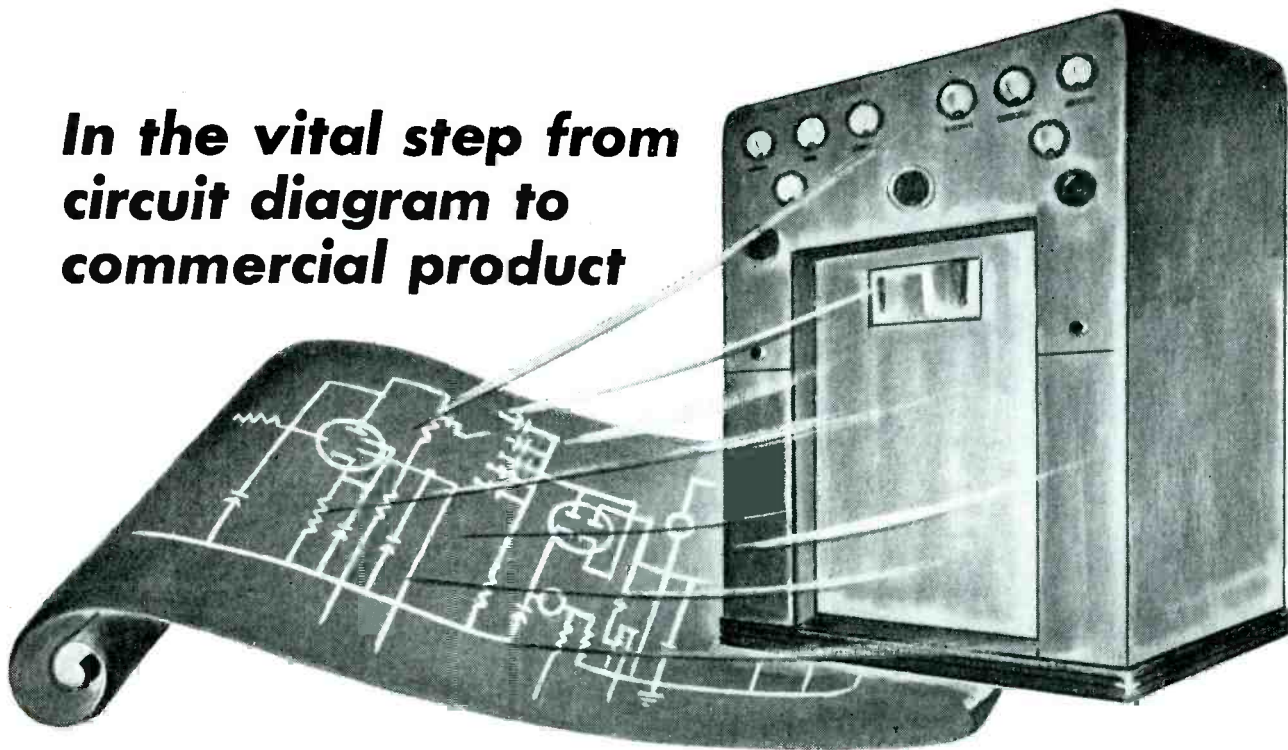

Fig. 2—Multiplier photo tube is used to operate indicating instrument

that the lamp can be located at a great distance from the phosphor and does not interfere with other parts of the apparatus. A lens L_2 is placed in front of the window W_1 and focuses the reduced image of the lamp filament on the phosphor; the totally reflecting prism PR is adjusted so that the light beam impinges on the phosphor container nearly at a grazing angle; the im-

**In the vital step from
circuit diagram to
commercial product**



S.S. WHITE FLEXIBLE SHAFTS help to make more effective designs

This broadcast transmitter shows clearly how coupling with S. S. White flexible shafts gives unrestricted freedom in placing variable elements in best positions while centralizing controls for convenient operation.

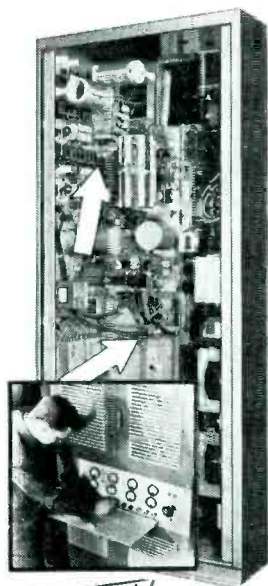

Translating an electronic circuit into a commercial product includes the problems of cabinet design and the arrangement of the various elements in the cabinet.

In many cases, more effective designs and arrangements can be made by using S. S. White flexible shafts as "couplings" between variable elements and their control knobs or dials, and between small motors and the mechanisms they drive.

Such use of S. S. White shafts gives unrestricted freedom in placing elements, often making it possible to save space, to facilitate assembly and wiring, to make operation and servicing convenient, and to improve and modernize appearance.

A wide range of coupling requirements can be met because of the large selection of S. S. White shafts available in both the power drive and remote control types. S. S. White engineers have helped work out many such applications and their cooperation is yours without obligation.

GET FULL INFORMATION AND DATA IN THIS FLEXIBLE SHAFT HANDBOOK

The subject of flexible shafts and their application is completely covered in this 256-page volume. A free copy will be mailed to you if you will write for it on your business letterhead and mention your position.



S.S. WHITE INDUSTRIAL DIVISION
THE S. S. WHITE DENTAL MFG. CO. DEPT. E, 10 EAST 40th ST., NEW YORK 16, N. Y.



FLEXIBLE SHAFTS AIRCRAFT ACCESSORIES
MOLDED PLASTICS
MOLDED RESISTORS FLEXIBLE SHAFT TOOLS

One of America's AAAA Industrial Enterprises

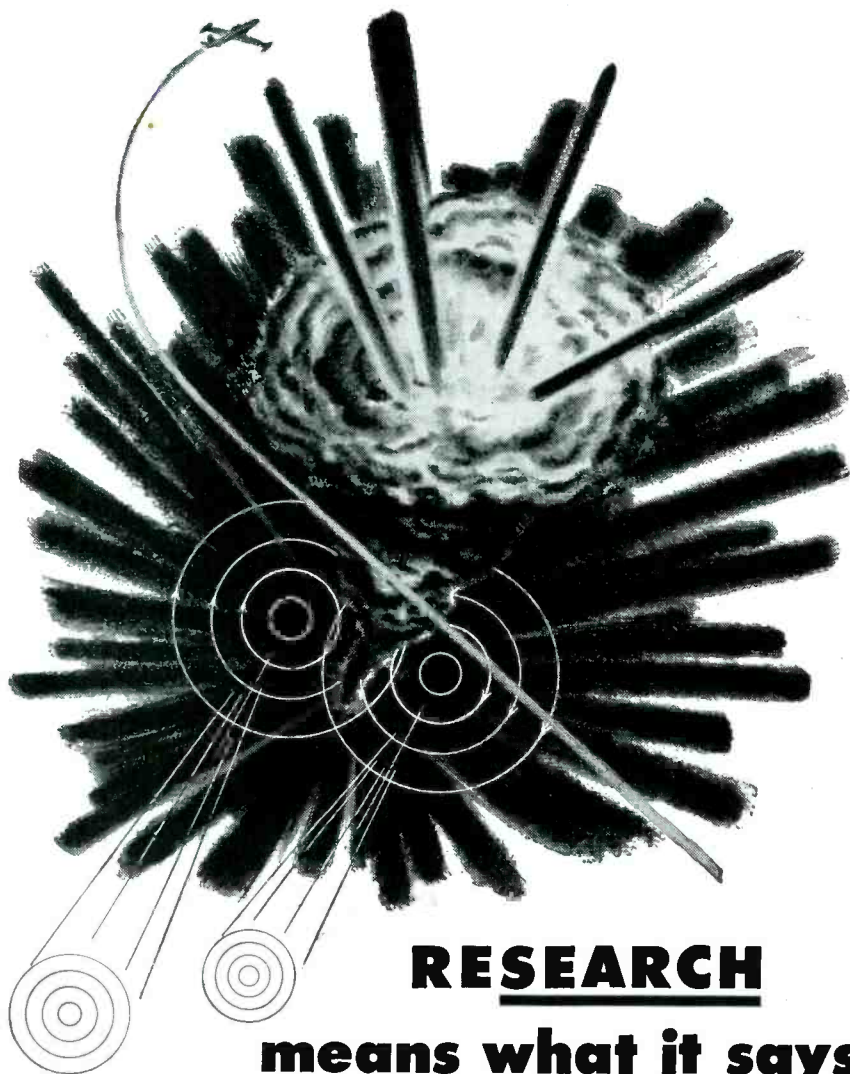

RESEARCH means what it says ... at Chicago Metal Hose!

Chicago Metal Hose Corporation's 43 years of experience went into manufacturing its part of *Jet Propulsion, Pressurized Cabins* and kindred marvels of a modern day.

For each of these scientific achievements began with research. A search by trained men months and years ago for better tools, better metals, better ways of doing things.

This pioneering has made for scientific advancement in the manufacture of flexible metal hose. Today, for example, Chicago Metal Hose Corporation can offer *you* outstanding advantages. Our engineers are specialists in the science of fabricating and corrugating Stainless Steel and other metals. Out of our long experience have come new techniques in *metal strip forming* and *welding* that are increasing efficiency on hundreds of industrial applications. If your problem involves flexible metal tubing, bellows or allied products... find out now how we can help you! Write today.



Flexible Metal Hose for Every Industrial Use



CHICAGO METAL HOSE CORPORATION

MAYWOOD, ILLINOIS

Plants: Maywood and Elgin, Ill.

age of the lamp filament has a surface of about 4 square mm. The light emanating from the phosphor is projected by a short focus lens placed in window W, into a photo-multiplier. The latter is contained in a light tight housing with only a narrow opening for the entrance of the phosphorescence light; moreover, the opening is protected against stray light by a cylindrical tube T. Only light emitted by the phosphor after the end of the excitation period can enter the photo-multiplier.

Electronic Circuit

The self compensating circuit used in connection with the photo-multiplier and shown in Fig. 2 is of the type reproduced in "Experimental Electronics" by R. H. Muller, R. L. Garman and M. E. Droz (Prentice Hall, N. Y., 1943).

A part of the voltage divider consists of two VR 150 tubes. With a fluctuating line voltage the variations in the voltage of dynode 7 are, therefore, larger than those in the voltage of the other dynodes and can be used to counterbalance any changes in the latter.

The anode current was measured without further amplification by means of a Rubicon galvanometer of a sensitivity of 4.10^{-9} amp per mm. The inertia of the instrument was sufficient to give steady deflections if the frequency of the phosphoscope was 6 flashes per second.

A photo-multiplier tube of the earlier type (R.C.A. 931) was at our disposal. Even with this tube we obtained sufficient amplification of the photocurrents produced by the phosphorescence by using 75 volts between adjacent dynodes, or 900 volts over-all. With the maximum voltage of 120 volts per step the anode output could have been increased more than tenfold. A similar high output could be obtained with the new 931-A tube at the normal 100 volts per step. Thus, either a galvanometer of lower sensitivity or a lower intensity of the exciting light could be used; the latter has some advantages because, after long and strong irradiation in the presence of O_2 , the phosphor begins to deteriorate.

Measurements were made by tak-

Here's the ACTUAL SIZE

In announcing another new and smaller POWERSTAT variable transformer, SUPERIOR ELECTRIC COMPANY offers in the Type 20 all the desirable characteristics of larger POWERSTATS together with design features only applicable to a unit of this size. Use of special core materials and an unusual mechanical arrangement permits mounting on $1\frac{1}{4}$ inch radius. The space required behind the panel is only $3\frac{9}{16}$ inches. Although small in physical dimensions, the rating of type 20 illustrates the advanced design and high quality workmanship.

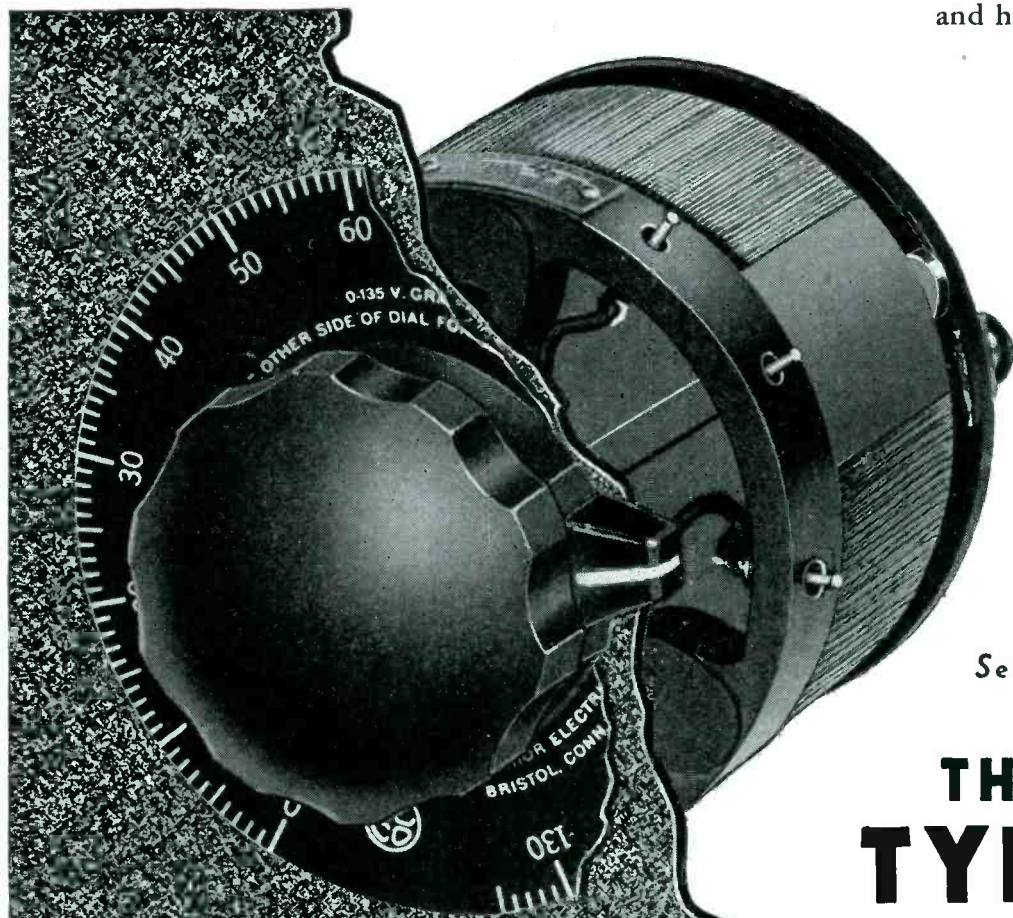

Input: 115 volt, 50/60 cycles, 1 phase.

Output: 0 to 135 volts, 3 amperes, 405 va.

Weight: 3.9 lbs.

Questions regarding technical data, delivery or price will be gladly answered by any SECO engineer.

Send for Bulletin LE

THE NEW TYPE 20

POWERSTAT

SUPERIOR ELECTRIC COMPANY

411 LAUREL STREET,

BRISTOL, CONNECTICUT

Eliminate Temperature Variations

with a **Conant** + **UNI-SCALE** — **Rectifier Assembly**

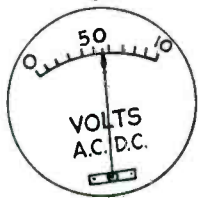

That's right! Here is a new instrument rectifier application that gives complete freedom from temperature errors. With "Uni-Scale," AC values are read on the same linear scale as DC values.

The vastly improved frequency response achieved by this new development will amaze you. "Uni-Scale" assemblies can be furnished in any of three Conant series (500, 160 or 160-C).

No priorities necessary—no waiting. Write today for data about "Uni-Scale," by Conant.

Instrument
Rectifiers

H. B. CONANT

Get this **BOOK!**

"Instrument Rectifiers and Rectifier Type Instruments," by H. B. Conant. Includes methods for compensating for instrumentation errors. Send 25c to cover cost of handling and mailing to

Instrument Rectifiers

ELECTRICAL LABORATORIES

6500 O STREET, LINCOLN 5, NEBRASKA, U. S. A.

20 Vesey St., New York 7, New York
85 E. Gay St., Columbus, Ohio
600 S. Michigan Ave., Chicago 5, Ill.
1215 Harmon Pl., Minneapolis 3, Minn.

2017 Grand Ave., Kansas City 8, Mo.
1212 Camp St., Dallas 2, Texas
378 Boulevard N. E., Atlanta, Ga.
4018 Greer Ave., St. Louis, Mo.

1526 Ivy St., Denver, Colo.
4214 Country Club Dr., Long Beach 7, Cal.
Export Div., 89 Broad St., N. Y. 4, N. Y.
50 Yarmouth Rd., Toronto, Canada

ing a reading of the galvanometer deviation every two seconds and inserting the points in a diagram of galvanometer readings versus time. Since then a Esterline-Angus recorder has replaced the galvanometer. These points correspond to phosphorescence intensity which is a nonlinear function of the O_2 pressure. The dependence of phosphorescence intensity on oxygen pressure can be determined by introducing small quantities of oxygen into the highly evacuated apparatus and measuring their pressure by means of a McLeod gauge. The quenching efficiency of oxygen of a given partial pressure is practically unaffected by the presence of nitrogen. Fig. 3 shows a calibration curve.

Operating Technique

When not used for actual measurements, the phosphor was always kept in the dark. Under these conditions it could be used during many weeks. If, after a lapse of

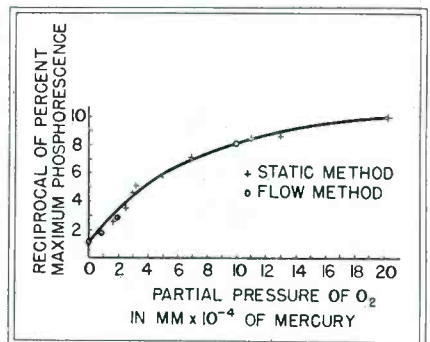

Fig. 3—Data from the phosphoroscope is converted from luminescence to partial pressure of oxygen by calibration curves similar to this one

time, it began to be less active, the height of the whole phosphoroscope with respect to the phosphor could be altered by a few millimeters, and a fresh spot of the phosphor gave again the former maximum phosphorescence.

The tube with the phosphor formed a part of a system which could be either connected to a diffusion pump or be flushed with N_2 or some other gas transporting small amounts of oxygen. Water vapor in the carrier gas must be frozen out in a trap cooled with liquid nitrogen before the gas reaches the phosphor. The carrier

SYLVANIA NEWS

ELECTRONIC EQUIPMENT EDITION

DEC. Published by SYLVANIA ELECTRIC PRODUCTS INC., Emporium, Pa. 1945

NEW, SENSATIONALLY SMALL SYLVANIA TUBE WILL PERMIT RADIOS OF CIGARETTE-PACK SIZE

Fuze-Type Tube Adaptable To All Battery Sets

Sylvania Electric announces a revolutionary new radio tube, the size of a peanut, which is as significant to the development of sets as the famous Sylvania Lock-In Tube.

Originally designed as the T-3 fuze-type tube, this tiny electronic unit is the commercial version of the radio proximity fuze tube developed by Sylvania. These tubes are being made

in low-drain filament types. They have long life and are so rugged that they won't break when dropped. Their low-drain characteristics take advantage of a new miniature battery developed during the war — permitting the design of radios ranging from the size of a package of cigarettes up to a deluxe farm receiver.

The new, tiny, complete electronic

unit will provide electrically and mechanically superior features similar to the Sylvania Lock-In Tube. Since the T-3 type of tube was originally designed to withstand the shock of travelling inside a spinning artillery shell, it will be even more rugged than the Lock-In, which has become known for its superiority for all types of sets.

THE T-3 TUBE LINES UP WITH OTHER FAMOUS SYLVANIA TUBES

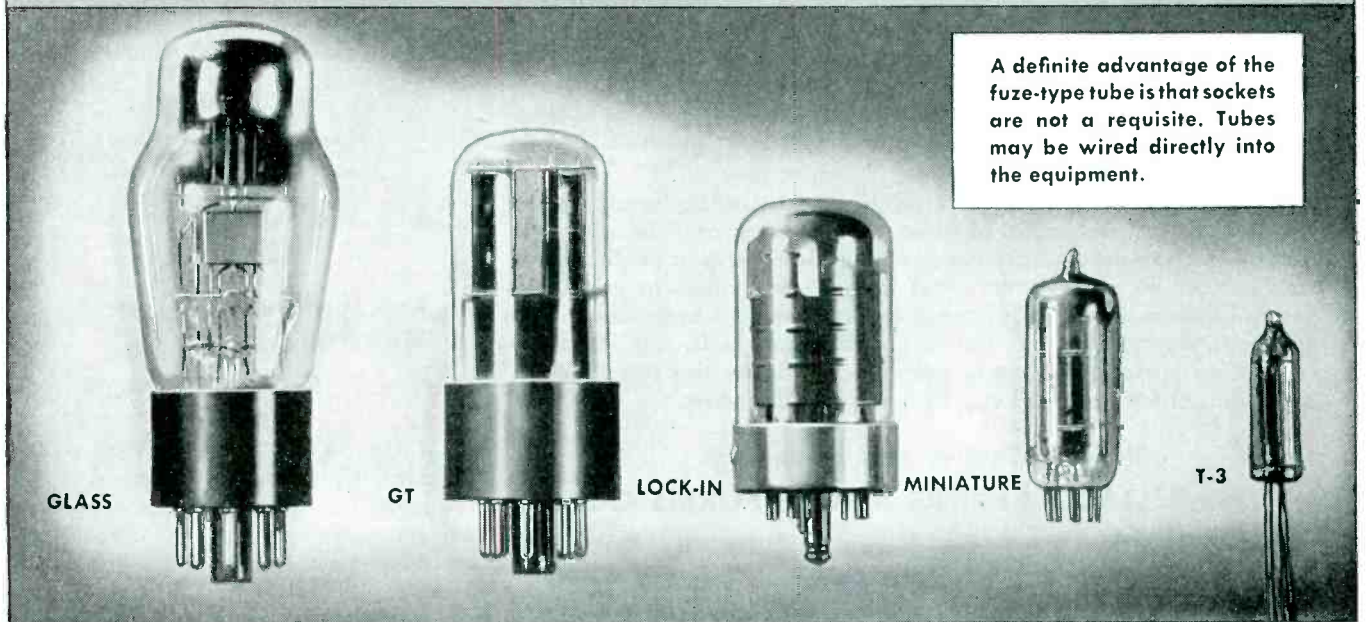

SYLVANIA ELECTRIC

Emporium, Pa.

MAKERS OF RADIO TUBES; CATHODE RAY TUBES; ELECTRONIC DEVICES; FLUORESCENT LAMPS, FIXTURES, WIRING DEVICES; ELECTRIC LIGHT BULBS

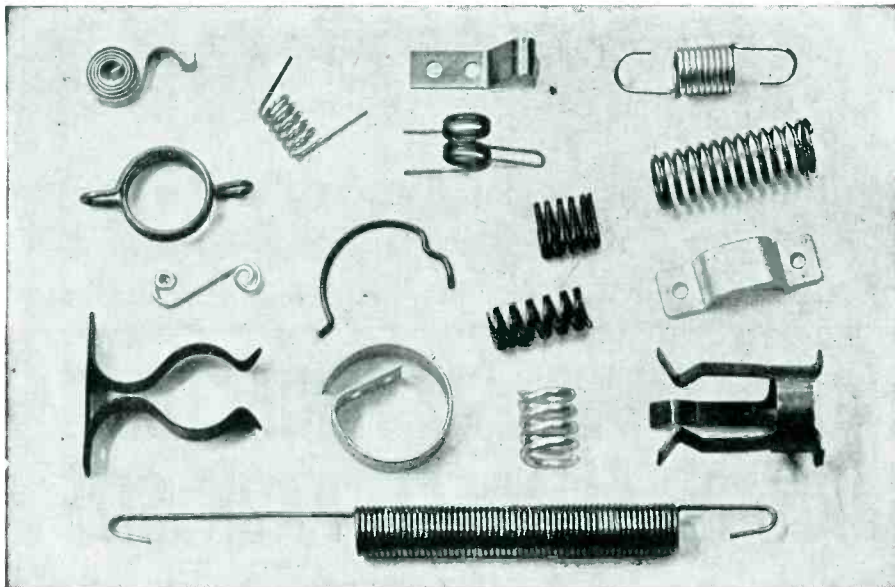

**IN PRODUCT PLANNING
DON'T OVERLOOK
SPRINGS!**



The long awaited competition for civilian markets is here! The race for the customer's dollar will be run on the intrinsic merit of your merchandise. The orders will go to producers who have the goods—not only in quantity but in quality.

One focal point of product superiority in mechanical or electrical devices is *springs*—usually hidden from the naked eye, but always a vital factor in performance and service life. One small spring, of trifling cost, may actually make or break your product. See to it that your springs are **RELIABLE**.

Reliable makes finer springs, stampings, and wire forms for all purposes, of all materials, of almost every type and design. Our competent engineers gladly cooperate in designing or re-designing your springs to work better, last longer, and often to cost less. Our executives, personally, are here to give you individual, conscientious attention. Our entire organization is in top shape to see that no spring problem is permitted to delay the readiness of your product for the market. Consult Reliable now.

Reliable Catalog sent on request.

THE RELIABLE SPRING & WIRE FORMS CO.

3167 Fulton Rd., Cleveland 4, Ohio

Representatives in Principal Cities

YOU CAN RELY ON

Reliable Springs

ROUND AND FLAT
WIRE SPRINGS

CLIPS

HOOKS

BENDS

LIGHT STAMPINGS

gas itself, e.g. N_2 or H_2 , must be of the very highest purity.

The method loses its sensitivity with increasing oxygen pressure; at pressures above 10^{-8} mm the phosphorescence is already quenched so much that a further increase in oxygen concentration has only a relatively small effect.

The quantity of oxygen produced per minute can be calculated from the partial pressure of oxygen measured during a certain period and the rate of flow, which in our experiments was only 3 cc per minute as controlled by a bubble counter. Because of this small rate of flow, the method becomes exceedingly sensitive as far as the rate of oxygen production is concerned.

It must be conceded that the quenching of the tryptaflavine phosphorescence by oxygen does not yield absolute quantitative values with an accuracy of more than about ± 50 percent if the calibration curve is not frequently controlled, because the sensitivity of the phosphor is not constant. However, in many cases the order of magnitude of the oxygen production and its relative changes during a series of experiments will be all that is desired and, at any rate, no other method is available that could yield similar results with comparable ease and in as short a time.

REFERENCES

- (1) Franck, J. and Pringsheim, P., *J. Chem. Phys.* 11, 21, 1943; Pollack, M., Pringsheim, P. and Terwoord, D., *J. Chem. Phys.* 12, 295, 1944.
- (2) Kautsky, H. and Hirsch, A., *Zs. f. anorg. allgem. Chem.* 222, 126, 1935.

• • •

Low Frequency Multivibrators

By CARL J. QUIRK
Signal Corps

THE LOWEST FREQUENCY at which a multivibrator will operate is determined by capacitor leakage. To determine the stability of such low-frequency circuits and their lowest possible frequency, an investigation using standard parts selected at random was conducted.

Basic Circuit

A simple free-running multivibrator shown in the accompanying illustration was used as the start-



TYPE 566-A
0.5 — 150 Mc
Accuracy: 2 — 3%
\$45

TYPE 758-A
55 — 400 Mc
Accuracy:
2%, \$28

TYPE 724-A 0.016 — 50 Mc
Accuracy: 0.25 — 1%, \$190

NEW TYPE 1140-A
240 — 1200 Mc

This is the latest addition to the G-R wavemeter line, with a butterfly-type tuned circuit in which the capacitive and inductive elements are built integrally and tuning is effected by simultaneously varying both. The rectifier is a sensitive and rugged silicon crystal detector with a microammeter for resonance indication. The scale on the frequency indicator drum is 9 inches long. The tuning unit and indicating meter are mounted in a plastic housing which can be held conveniently in one hand. The instrument is accurate to 2% of the indicated frequency. Price: \$65

WAVEMETERS for the ENTIRE COMMUNICATIONS SPECTRUM

• Simple, tuned-circuit wavemeters, either with or without resonance indicators, always will find wide application in the laboratory. Direct reading, compact, lightweight, rugged, easy to use, and with accuracy more than ample for many uses, these meters effectively supplement the highly accurate heterodyne frequency meter for many types of measurement.

Wavemeters will always be useful for approximate measurements of coil ranges, oscillator spans, preliminary lining up of transmitters, locating and naming harmonics in either the receiver or the transmitter, and for general experimental work.

For almost thirty years General Radio Company has pioneered in the design and manufacture of accurate wavemeters. General Radio's frequency measurement program, which

has resulted in the finest primary standard of frequency to be obtained anywhere, has always had as a concurrent project the development of a line of wavemeters to cover as much of the useful radio spectrum as the art required.

The four instruments depicted cover the entire frequency range from 16 kc to 1,200 Mc. All of these meters are calibrated in our Calibration Laboratory in terms of the G-R Primary Standard of Frequency. All are built to the same standard of G-R quality as is found in the most precise frequency measuring assembly we manufacture.

G-R wavemeters are correctly designed, skillfully engineered, carefully manufactured and accurately calibrated. Write for detailed information.

GENERAL RADIO COMPANY

Cambridge 39,
Massachusetts

90 West St., New York 6

920 S. Michigan Ave., Chicago 5

1000 N. Seward St., Los Angeles 38

Depend on
Permoflux for
Better Acoustical
Reproduction

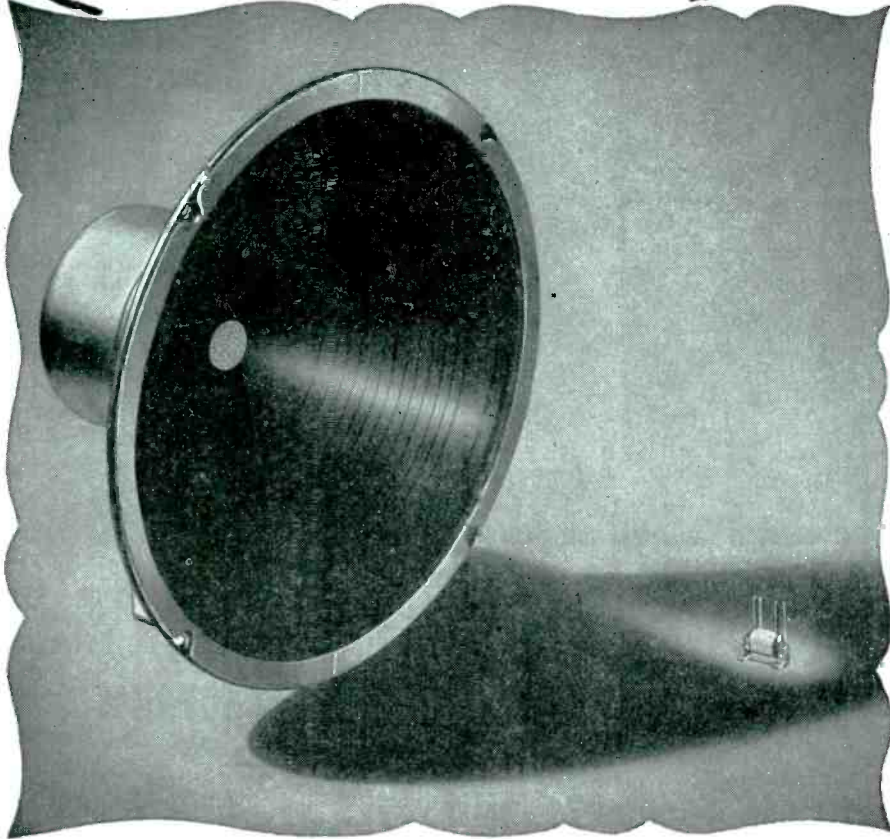

The many specialized Permoflux designs and engineering developments that have so notably demonstrated their superiority in wartime applications are available to improve the performance of your peacetime products. Why not consult specifically with our representative on your own problem?

TRADE MARK
PERMOFLUX
PERMOFLUX CORPORATION
4900 WEST GRAND AVE., CHICAGO 39, ILL.



PIONEER MANUFACTURERS OF PERMANENT MAGNET DYNAMIC TRANSDUCERS

ing point. Disregarding for the present the capacitor leakage resistance shown dashed, the duration of a cycle is expressed by $T = R_{G1} \cdot C_1 R_{G2} \cdot C_2$, if $R_{G1} \gg R_{P2} \cdot R_{V2} / (R_{P2} + R_{V2})$ and $R_{G2} \gg R_{P1} \cdot R_{V1} / (R_{P1} + R_{V1})$ where R_{V1} and R_{V2} are the d-c resistance of V_1 and V_2 respectively. If resistances are given in megohms and capacitances in microfarads, the period will be in seconds.

Because these conditions are usually satisfied in multivibrators, this order of magnitude equation can be used. As will be shown later, results calculated by this equation will not always be accurate, but for the purpose of this discussion they will be close enough.

Multivibrator Operation

To illustrate the manner in which the leakage of the coupling capacitors limits the lowest frequency of operation, the function of the circuit is reviewed. An increase of

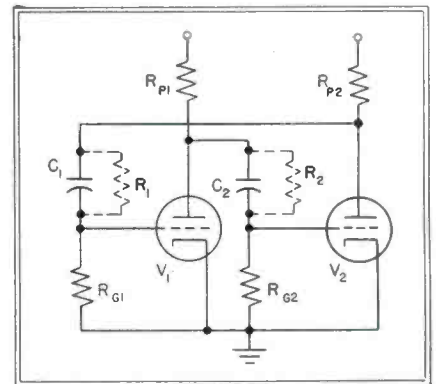

In the multivibrator used to determine the lowest frequency of operation, grid resistors were finally omitted and the leakage of the capacitors used to perform their function

current in V_2 lowers its plate voltage. This reduction in plate voltage is coupled through C_1 to the grid of V_1 thereby reducing the current in V_1 and causing an increase in the plate voltage which in turn is coupled to the grid of V_2 through C_2 causing the plate current of V_2 to further increase. This series of events continues until V_1 is cutoff, at which time V_2 will be drawing a large plate current. A very short time compared to the complete cycle is required for this action.

The effect is a sudden change in voltage across C_1 from the full

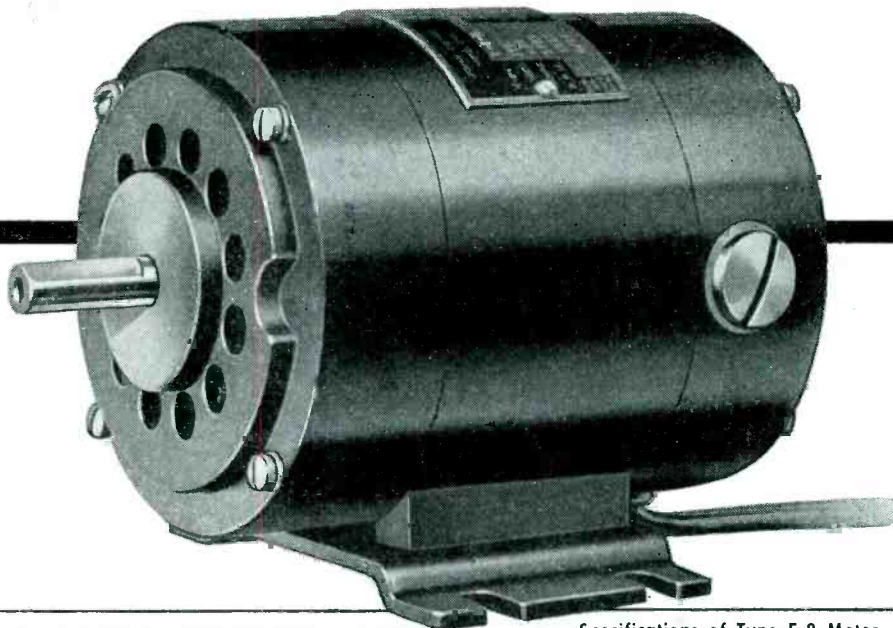

115 VOLT CONTINUOUS DUTY IN 25° C. AMBIENT					
Maximum H.P.	1/12	1/16	1/25	1/35	1/50
R.P.M.	7500	5800	3800	2800	1750
Amps Input	.8	.67	.46	.38	.32
Starting Torque in % of F. L. Torque	200 min.	200 min.	200 min.	200 min.	200 min.

Specifications of Type E-8 Motor

DIMENSIONS

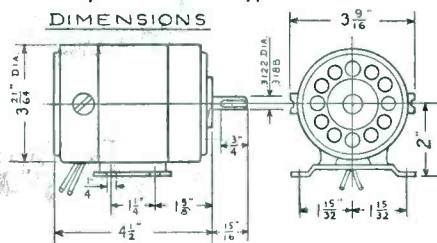

Your new product will perform *better* and have *additional* sales appeal . . . with a dependable **Oster** motor



A modern, scientifically engineered motor, such as any one of many different sizes and styles made by Oster, is of prime importance in making your product perform satisfactorily.

The model E-8 Oster Motor illustrated above gives you the advantages of light weight, compactness, and dependable, trouble-free performance. Here are the details:

HOUSING — Die cast, open or totally enclosed.

FINISH — Black, baked enamel.

BEARINGS — Single or shielded ball bearings, or sleeve bearings.

BRUSHES — Furnished with metal graphite or electro graphite brushes of ample size to assure unusually long brush life. Phosphor bronze or beryllium copper brush springs.

WINDINGS — Available for operation on 12, 24 or 115 volts, in shunt, series, and split series types.

MOUNTINGS — Available for either base or flange mounting.

MODIFICATIONS — Motors can be furnished with special shaft extensions, finishes, leads, etc. Motors can also be furnished for operation in high ambient temperatures and high altitudes.

All ratings and data are approximate.

Let us help you fit this and other famous Oster Motors to your requirements.



John Oster Manufacturing Co.
DEPARTMENT L-29 • RACINE, WISCONSIN

Pilots depend on Erco

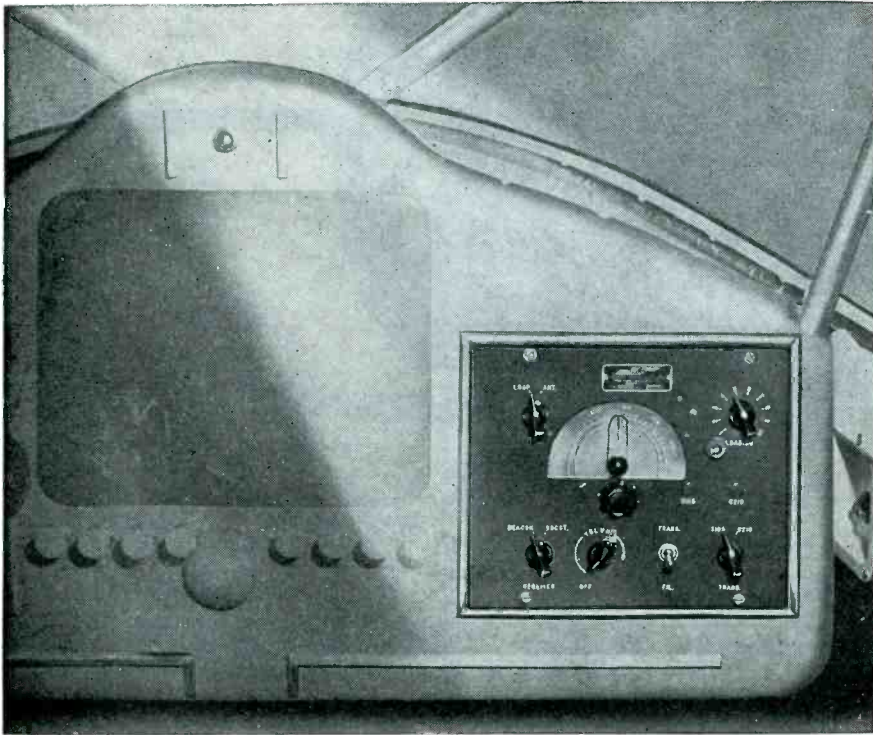

Here is the ERCO FLIGHT MODEL 60 Transmitter-Receiver installed in the Fairchild 24 of Sperry Gyroscope Co.

This custom built equipment is of special design to meet rigid specifications of engineering and symmetry. It marks one of a series of customized FLIGHT MODELS by ERCO.

The illustrated Flight Model dual unit is designed to conserve panel space. All radio frequency circuits are in the panel section. The power supply-modulator is a separate unit which may be installed in the baggage compartment, under seat or any convenient location. Receiver covers both the weather band and broadcast band with ample sensitivity and optimum selectivity. Transmitter operation on two pretuned frequencies, 6210 and 3105 KC, with carrier power of 15 and 20 watts respectively.

Aircraft manufacturers, operators and private owners look to ERCO for satisfaction in flight communications. Completely customized service by ERCO includes Airport Control Towers and all Airport Installations; VHF Receivers and Companion Transmitters; Ground Station equipment and antenna systems. Your requirement is our assignment.



ERCO RADIO LABORATORIES
HEMPSTEAD, NEW YORK
Manufacturers of CUSTOM BUILT RADIO APPARATUS

plate supply voltage to a much lower value. But this reduction in voltage across C_1 cannot occur instantly, thus the voltage drop across R_{o1} due to the discharging current of C_1 causes V_1 to go rapidly to cut-off and remain cut off until the discharge current becomes low enough so that the voltage across R_{o1} is equal to the cutoff bias of the tube, at which time the circuit will again switch and cause V_2 to become cut off and V_1 to conduct.

The period during which V_1 will be at cut off will be designated as T_1 and determined by the product $R_{o1}C_1$. This condition will hold true if R_{o1} is much greater than the parallel resistance of R_{p2} and R_{v2} (as mentioned above) and much less than the leakage resistance of the capacitor C_1 itself. In most low frequency multivibrators the first condition will be satisfied but the second will have to be determined by trial and error. Likewise the period during which V_2 will be at cutoff will be designated as T_2 and determined by the product $R_{o2}C_2$.

Effect of Capacitor Leakage

Referring to the illustration, note the resistance R_1 and R_2 which represent the leakage resistances of the associated capacitors. Because means to measure leakage resistances of capacitors is not available to most experimenters, the only way one can be sure whether this leakage is going to affect the operation or not is to actually build the circuit and test it. A number of combinations were tried and the results presented in Table I. In all combinations R_{p1} and R_{p2} are 0.5 meg, the plate supply to the 6SL7 tube is 250 volts.

In the first six tests it was decided to determine how large R_{o1}

Table I—Measured periods of long time-constant multivibrators

$C_1=C_2$ in μf	$RG_1=RG_2$ in megohms	T_1 in seconds	T_2 in seconds
0.5	1	1.5	1.5
0.5	3	4.5	4.5
0.5	5	8	7
0.5	10	15	15
0.5	15	24	19
0.5	18	27	24
1.0	18	50	50
8.0	18	170	153
16.0	18	345	235
16.0	56	1020	1140

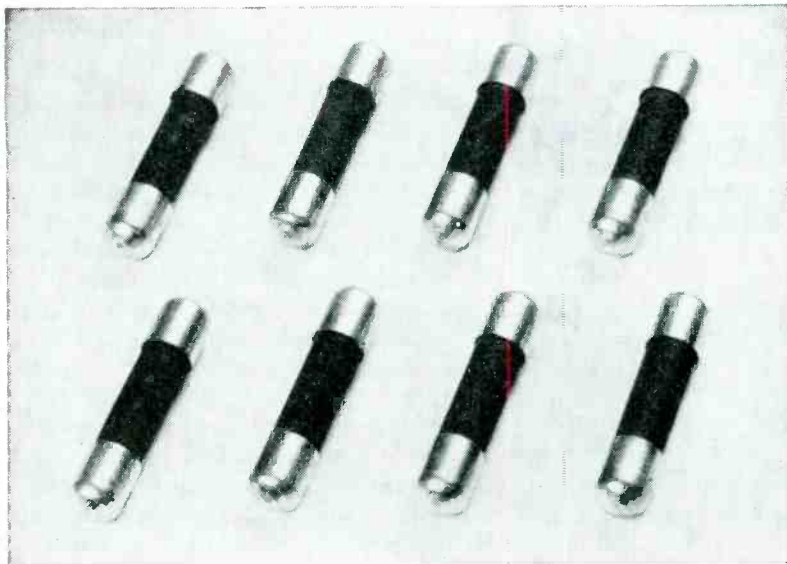

Let "GLOBAR"TM Temperature- Sensitive Resistors . . .

- 1 Reduce your manufacturing cost
- 2 Simplify your product
- 3 Provide exceptional accuracy
- 4 Give you top performance

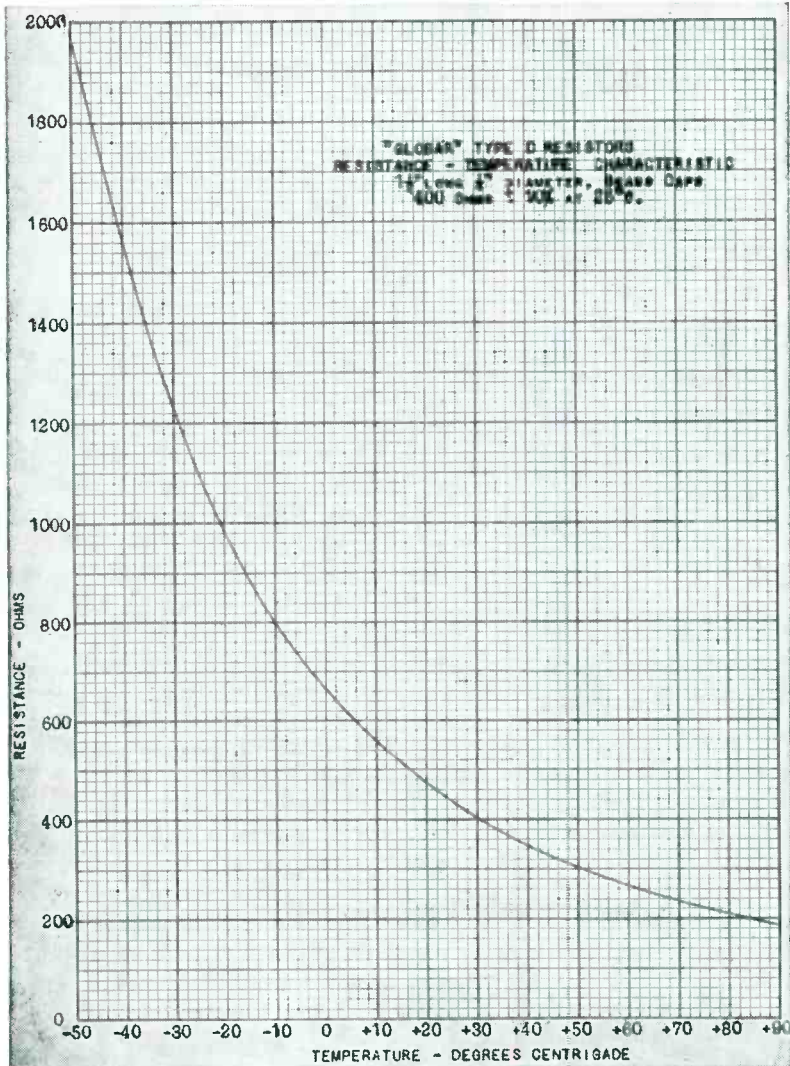

"GLOBAR" Type D Resistors have an extreme negative Resistance-Temperature characteristic which means that they will do a wide variety of jobs, accurately and economically. For example, one manufacturer uses them as Resistance Thermometers while another uses them as Temperature Compensators. They also perform a wide variety of useful functions in many electronic devices.

Light-weight—compact—efficient—reliable—"GLOBAR" Type D Resistors never get out of adjustment, because their function is purely electrical instead of mechanical. They may be used on A. C. or D. C. circuits.

These resistors are manufactured to meet the specific needs of each application, so be sure to include full information about your circuit when writing. We will be glad to provide working samples on request.

By the way, if your engineers haven't yet investigated "GLOBAR" Ceramic Resistors we invite them to do so without obligation. Write to The Carborundum Company, Global Division, Niagara Falls, New York.

"Global" Ceramic Resistors
by CARBORUNDUM
TRADE MARK

(*CARBORUNDUM" and "GLOBAR" are registered trade marks of and indicate manufacture by The Carborundum Company)

Consult Sigma

IF YOUR RELAY REQUIREMENTS ARE:

**PRECISION — RUGGEDNESS
SENSITIVITY**

TYPE 4F



TYPE 4F

This is the Series 4 relay with open frame construction. It is compact ($1\frac{1}{8}'' \times 1\frac{1}{8}'' \times 1\frac{1}{2}''$), fast (2 - 3 milliseconds with sufficient power), sensitive (.010 watts minimum).



TYPE 4A

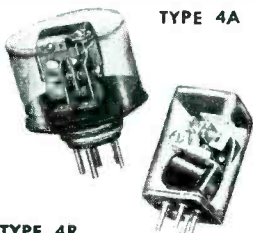

TYPE 4R

TYPES 4A AND 4R

These are the basic Series 4 construction with enclosures. The 4A is $2\frac{1}{8}''$ diameter and $2\frac{1}{8}''$ high, the 4R $\frac{1}{2}'' \times \frac{1}{2}'' \times 2\frac{5}{8}''$. Both have a 5-pin plug in base. The 4A can be sealed (4AH).



TYPE 5F

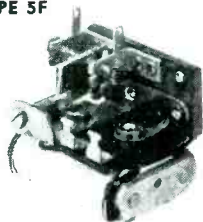

TYPE 5F

This is the Series 5 relay with open frame construction. It is exceedingly sensitive (.0005 watts minimum), very rugged, precise in operation even under extremes of temperature and vibration.



TYPE 5R

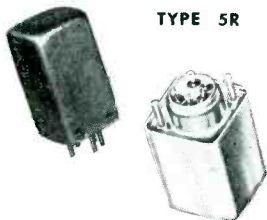

TYPE 4 (or 5) RJLB2

TYPES 5R AND 4 (or 5) RJLB2

5R is the Series 5 construction in an enclosure ($1\frac{1}{2}'' \times 1\frac{1}{2}'' \times 2\frac{1}{4}''$) with a 5-pin plug in base. The RJLB2 is a hermetically sealed enclosure with two mounting bolts available for both the Series 4 and 5 relays.

'Sigma specializes in Relay Applications where precision of operation and dependability, under any adverse condition, are essential.

Sigma, . . . A recognized leader in the Sensitive relay field, offers YOU a quality product, priced right and engineered to meet your specifications.

Write today explaining your requirements.

SIGMA
Sigma Instruments, Inc.
Sensitive **RELAYS**

62 CEYLON ST., BOSTON 21, MASS.

could be made before the leakage of $0.5 \mu\text{f}$ capacitors would affect operation. However, as can be seen from Table I, the leakage resistance of the capacitors is much greater than 18 meg because the period increases linearly with resistance.

Increasing the capacitors to $1 \mu\text{f}$ with the same grid resistors increased T to twice its previous value. However increasing the capacitors to $8 \mu\text{f}$ only increased T five times (instead of eight), but increasing the capacitance in the next test to $16 \mu\text{f}$ doubled the time as the equations predict. It should be noted at this point that these long time-constant circuits are not stable and will vary as much as 30 percent over short periods of time.

Grid leaks were increased to 56 meg. Tabulated results show that T is approximately 6 minutes longer than calculated.

Long Period Multivibrator

At this point it was decided to design a multivibrator with a period of a few hours. Assuming that the capacitors would have a leakage resistance much higher than the resistors, very large resistances and capacitances would have to be used. For example, to build a multivibrator with a T of two hours, R_{G1} and R_{G2} would have to be 225 meg each if C_1 and C_2 were $16 \mu\text{f}$ each. Because these resistances are difficult to obtain, it was decided to omit the grid resistors and rely on the leakage resistances of the capacitors to provide capacitor discharge paths.

The resulting circuit is very simple and requires a minimum of parts. Results of using various capacitors in this circuit are presented in Table II. The circuit used the same plate supply, plate loads, and tube as that from which the data of Table I were obtained.

Leakage Resistances

With R_{G1} and R_{G2} omitted from the circuit, it is relatively simple to determine the leakage resistances of the capacitors. Because the time involved in charging or discharging either capacitor is a function of both capacitance and the leakage resistance, $R_1 = T_1/C_1$, and $R_2 = T_2/C_2$. Values obtained will not

SPEER GRAPHITE ANODES DON'T WARP

... when tubes are made

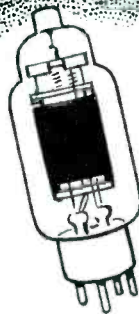

when tubes are used



SPEER Graphite Anodes help tube manufacturers produce closely matched tubes that give closely matched performance — because SPEER Graphite Anodes defy warping.

The relative position of tube elements doesn't change when SPEER Graphite Anodes are used, and tube performance remains uniform throughout the life of the tube. Because they have a low coefficient of expansion and no softening point (graphite sublimates without melting at 3500° C), SPEER Graphite Anodes hold their shape at the high temperatures encountered in the exhaust stage of manufacture and during overload operation — temperatures at which other anode materials soften or distort.

SPEER Anodes are made of a specially processed, highly pure, heat-dissipating, homogeneous graphite. They minimize envelope darkening, prevent hot-spots, improve degassing qualities, allow wide latitude of anode design.

The many advantages of SPEER Graphite Anodes listed here are available to manufacturers and users of almost every type of electronic tube. Write today for further details, without obligation.

SPEER GRAPHITE ANODES:

1. Increase allowable plate power dissipation
2. Lower temperatures of associated tube parts
3. Withstand severe overloads
4. Defy warping
5. Prevent hot spots or fused holes
6. Minimize bulb darkening and insulator leakage
7. Improve degassing qualities
8. Decrease gas troubles
9. Enhance tube appearance
10. Provide precise anode dimensions
11. Produce uniform tube characteristics
12. Retain original dimensions in service
13. Maintain normal tube characteristics
14. Allow wide latitude of anode design

CHICAGO • CLEVELAND • DETROIT
MILWAUKEE • NEW YORK • PITTSBURGH

SPEER
CARBON COMPANY
ST. MARYS, PA.

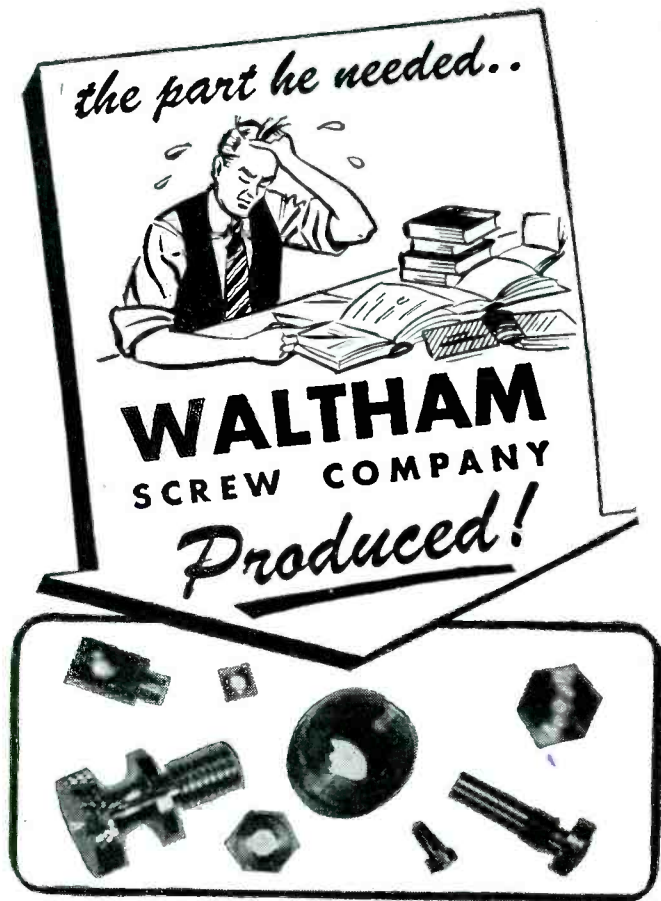

Tiny but essential are screws and other threaded members of modern industrial assemblies. Thousands of sizes and types of screw machine products are on the market for ready sale. Yet today sees some new design of instrument or machine in which mechanical function must derive from a screw machine product heretofore never known.

At this point Waltham Screw Company, its designers, its engineers and its precision machines come forward with the ability to produce the vital unit, to engineer it to exact specifications in whatever volume required.



The wasp, whose hexagonal cell-measurement never varies, is Waltham Screw Company's hall-mark. It denotes *utter precision*.

Telephone Today Collect
Waltham 5830

WALTHAM SCREW
C O M P A N Y
75 Rumford Ave.
Waltham, Mass.

be too accurate, but because in practical design of a very low-frequency multivibrator it is sufficient to know the approximate value of leakage resistance of the capacitors to be used, the measured results shown in Table II suffice.

Although in a conventional multivibrator designed for operation at very low frequency a 0.001 μf capacitor would not be used, capacitors of this value were checked to determine how closely the leakage of each checked with the others. As mentioned before, any long time-constant circuit will vary considerably from cycle to cycle, therefore it was difficult to decide how different the leakage values of these capacitors actually were. However, readings were taken at random and the results tabulated. The period of each combination runs fairly close to the others.

In test 4 the 0.001 mica capacitors were rated at 1200 d-c working volts which probably accounts for their higher resistance. In tests 5 and 6 the capacitors were increased five times but T did not increase five times because, as it is to be expected, as capacitance increases for the same voltage rating capacitors, the leakage resistance decreases. However, using higher capacitance capacitors increases the period somewhat. In test 11 the 0.5 μf capacitors were rated at 400 volts and were an inferior grade. This fact undoubtedly accounts for the much lower resistance of these units. All other capacitors were rated at 600 volts and were of good quality.

In several of the tests one capacitor of a combination had much greater leakage than the other. This phenomena is to be expected because any variation will appear as a greater percent of the period than it would with smaller capacitances.

Practical Circuit

With relatively small capacitors, fairly low frequency multivibrators can be easily built by omitting the grid resistors. This circuit fulfills the requirement of having a very low frequency and using small capacitors. With two 8.0 μf capacitors, a period of three hours can be realized.

It may be argued that a multivi-

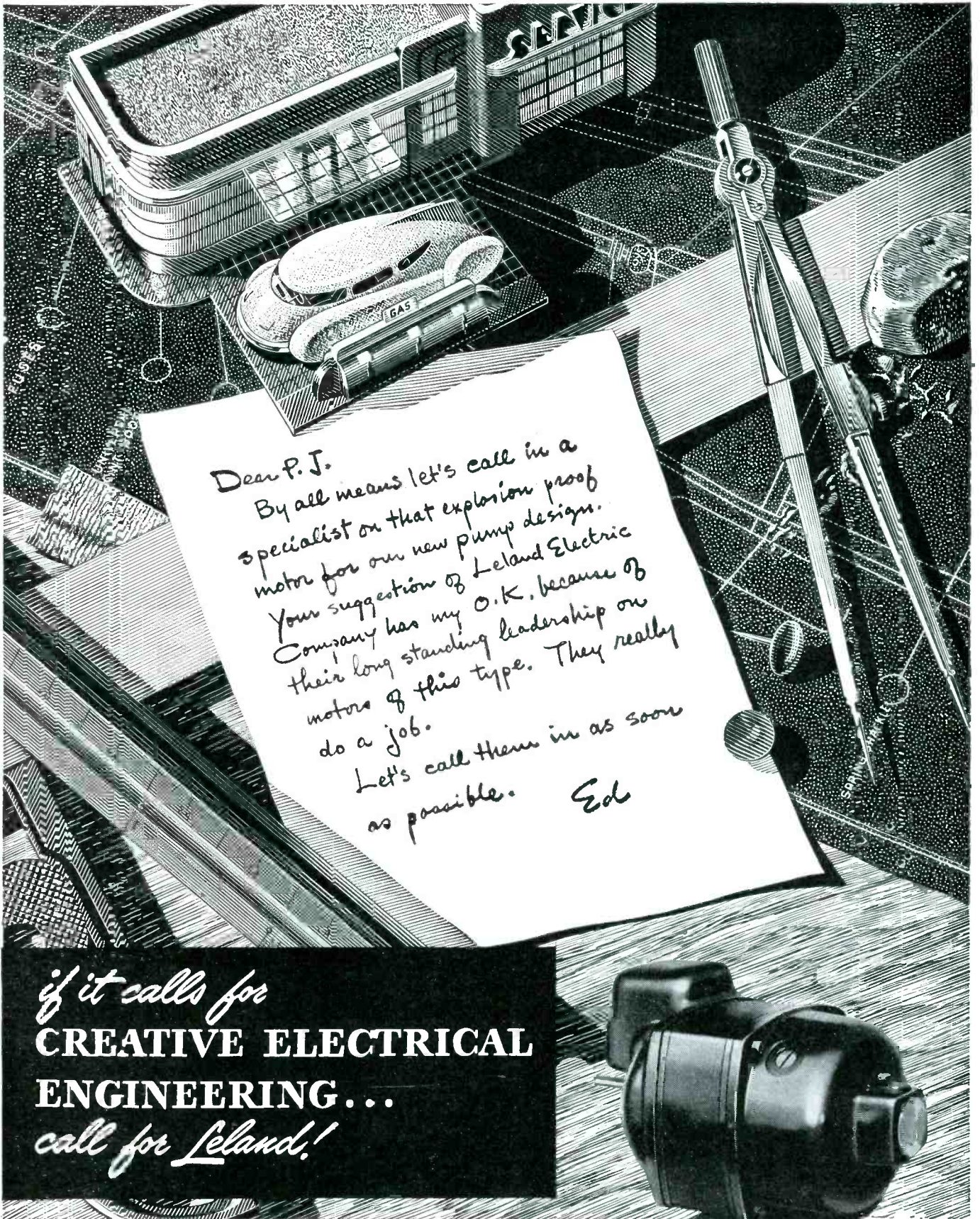

Dear P. J.
 By all means let's call in a specialist on that explosion proof motor for our new pump design. Your suggestion of Leland Electric Company has my O.K., because of their long standing leadership on motors of this type. They really do a job.
 Let's call them in as soon as possible. Ed

if it calls for
**CREATIVE ELECTRICAL
 ENGINEERING...**
call for Leland!

THE Leland ELECTRIC COMPANY

DAYTON, OHIO • IN CANADA, LELAND ELECTRIC CANADA, LTD. ... GUELPH, ONTARIO

A MESSAGE FOR:— CIRCUIT BREAKER MANUFACTURERS

Many manufacturers now use a uniform size and shape of thermostatic bimetal element in building a "line" of circuit breakers covering a range of circuit ratings. This is made possible by selecting a type of bimetal based on its electrical resistivity. The following types cover a wide range of electrical resistivity values:

Electrical Resistivity Recommended Type of
ohms per cir. mil ft. Thermostatic Bimetal

- 95 Chace No. 3300
- 125 Chace No. 6125
- 150 Chace No. 6150
- 200 Chace No. 6200
- 300 Chace No. 6300
- 400 Chace No. 6400
- 480 Chace No. 2400
- 650 Chace No. 6650
- 850 Chace No. 6850

Chace makes 35 types of thermostatic bimetal, each offering specific advantages. Our engineering department will gladly assist you in selecting the type bimetal best suited to your requirements. Sold in sheets, strips, shapes, and sub-assemblies to specifications.

W.M. CHACE CO.
Manufacturers of
Thermostatic Bimetals and Special Alloys
1630 BEARD AVE • DETROIT 9, MICH.

brator in which the grid resistors are omitted will not be very stable in frequency. This is granted, but it is also true that if a multivibrator is designed with a period of one hour using capacitors of 16 μ f and grid leaks of approximately 112 meg, it will be no more stable than one using two 0.1 μ f capacitors without grid leaks. In either case if we desire a very stable multivibrator for low frequencies it will have to be synchronized.

There is a current path from the grid sides of the capacitors to the

Table II—Periods of Multivibrators Using Capacitor Leakage Paths

$C_1=C_2$ in μ f	Type*	R_1 in megohms	R_2 in megohms	T_1 in min & sec	T_2 in min & sec
0.001	tube	145,000	83,000	2:25	1:23
0.001	"	65,000	60,000	1:05	1:00
0.001	"	95,000	145,000	1:35	2:25
0.001	mica	197,000	126,000	3:17	2:06
0.005	"	27,600	24,000	2:18	2:00
0.005	"	20,600	52,000	1:43	4:20
0.01	"	30,000	125,000	5:00	10:25
0.1	tube	32,600	6,350	54:20	10:35
0.25	tube	10,080	1,080	42:00	4:30
0.25	"	308	2,440	1:17	10:10
0.5	"	100	136	0:50	1:08
8.0	can	375	1,222	50:	163:
8.0	"	990	562	132:	75:

* All capacitors are paper insulated unless otherwise stated

negative side of the power supply through the tube base and socket. If the leakage of this path is of the same order as that of the capacitors, it has as much to do in determining time constant as do the capacitor leakages.

During measurements for Table II a change was made from a bakelite tube socket to a Steatite socket and no difference was noted.

• • •

Modulation by Feedback

By ROBERT C. SHAW
Bell Telephone Labs., Inc.
Patented June 26, 1945, No. 2,379,042

MODULATION is accomplished by controlling the amount of negative feedback. The accompanying figure illustrates the general principle. The carrier is amplified in a low-distortion, stabilized, negative-feedback amplifier. The loss in the carrier feedback loop is varied in accordance with a modulating potential applied within the feedback loop, thereby producing a modulated wave in the output of the carrier amplifier.

Where the output voltage is represented by E , the carrier input to

NON-LINEAR Potentiometer

High Linearity

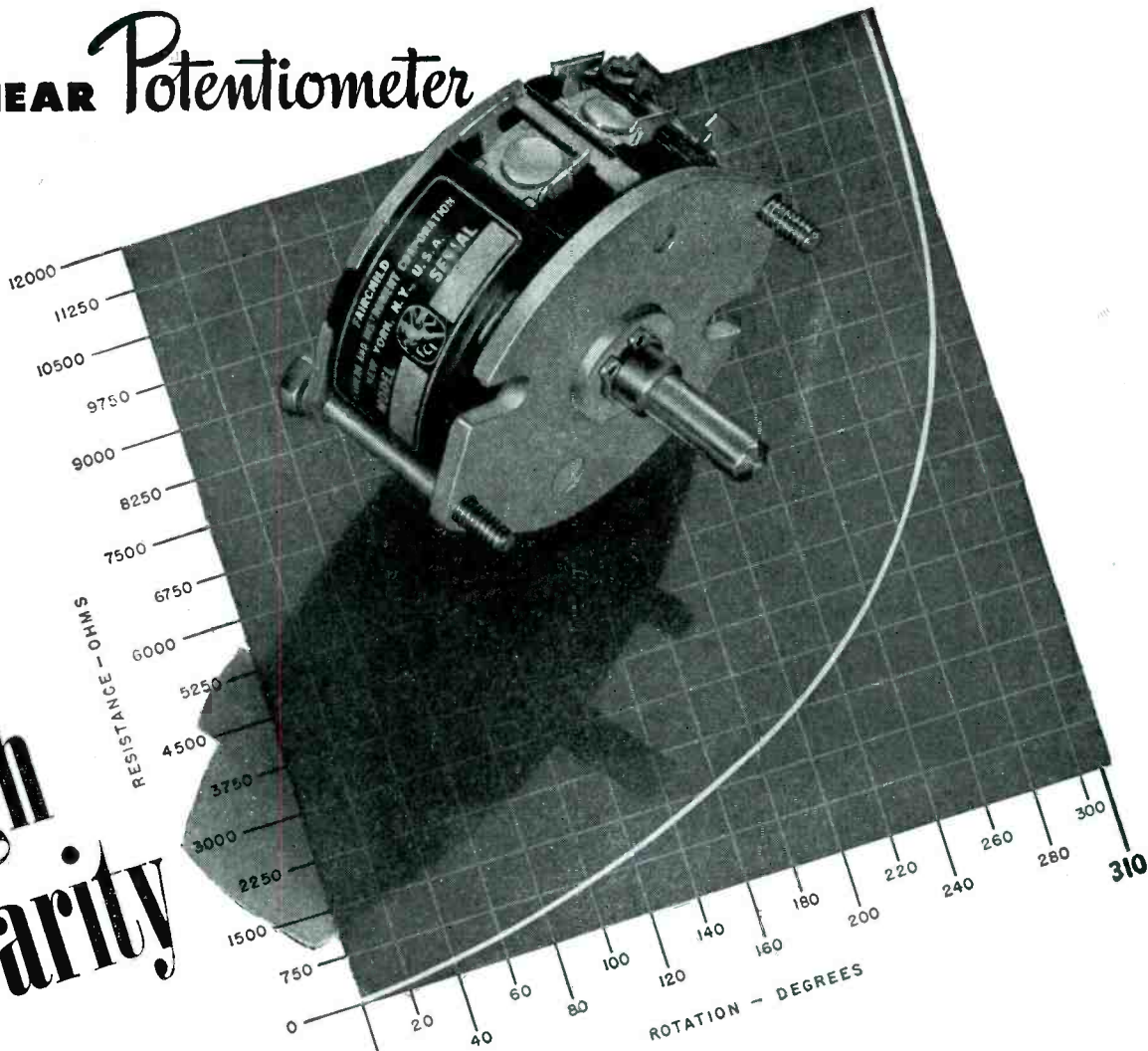

Performance within **1%** of the plotted curve

Look to the Fairchild *non-linear* Potentiometer for unexcelled accuracy. War born — to meet the never-before-attained accuracy required of T attenuators in airborne, electronic lead computing gunsights — it proved its accuracy in battle.

Industry is now offered the full advantages of this war-time development. It eliminates intricate, space-consuming, expensive mechanical cams and linkages and electrical units — used with or without linear potentiometers.

Fairchild's non-linear Potentiometer offers these excellent design possibilities: Small size — being 1 $\frac{5}{8}$ " in diameter, 25/32" thick, with shaft diameter optional, but usually $\frac{1}{4}$ " . . . high linearity — ability to follow a plotted curve of resis-

tance versus a maximum rotation of 310° within an error of 1% or less at any point on the curve . . . great flexibility for reproducing almost any desired curve — sine, cosine, tangent, hyperbole, square-root, logarithmic and special empirical relationships.

For further information address: *New York Office: 475-10th Avenue, New York 18; Plant: 88-06 Van Wyck Boulevard, Jamaica 1, N. Y.*

CONSIDER THESE APPLICATIONS

Fairchild non-linear Potentiometers can be adapted industrially to: instruments for process control, motor drives . . . computing and analyzing instruments and equipment . . . electronic heating . . . electro-medical equipment . . . aircraft and ship radio transmitter control rooms . . . AM, FM and television transmitter controls . . . recording, transcription and public address sound equipment . . . telephone long lines, etc.



Fairchild CAMERA AND INSTRUMENT CORPORATION

INSTRUMENTS — *precisionized* — mechanically and electronically — for finer performance

The Answer TO YOUR INSTRUMENT PROBLEMS

Burlington

PANEL INSTRUMENTS

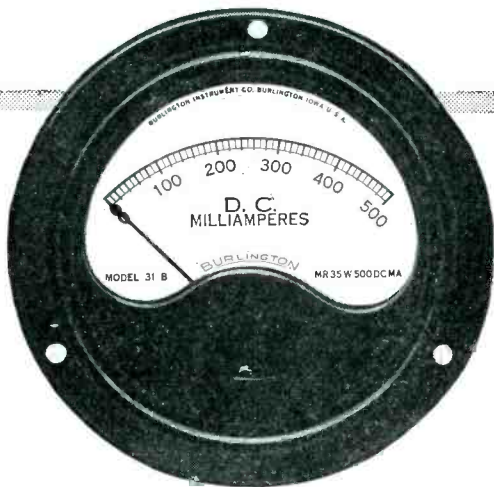

Burlington Panel Instruments are designed and built to give dependable service with guaranteed accuracy. They are available in a complete line of AC or DC Ammeters, Voltmeters, Milliammeters, and Microammeters. The wide selection of sizes and case styles offer instruments that are ideal for your particular application.

Write today for full details — our engineers will recommend the precise Burlington Instruments required to solve your instrument problems.

BURLINGTON INSTRUMENT CO.

104 Fourth St., BURLINGTON, IOWA

B

PANEL INSTRUMENTS • VOLTAGE REGULATORS • AUTOMATIC SYNCHRONIZERS • FREQUENCY REGULATORS

the high frequency amplifier is E_c , and the complex feedback factor is β ; the output is given by $E = E_c / (-\beta)$ provided $|\mu\beta| \gg 1$. A variation in feedback factor from approximately 22 to 35 db for an amplifier having $\mu = -1,000$ results in the carrier being modulated 67 percent in one particular application. With feedbacks of this order, the nonlinearity introduced

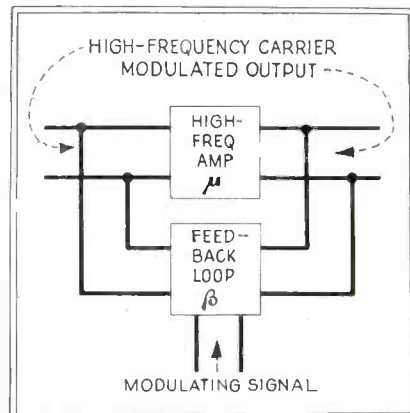

Basic circuit consists of an amplifier, a feedback loop, and a means of controlling the loss in that loop

by assuming that $|\mu\beta| \gg 1$ gives distortion of only a few percent.

Modulation can be introduced in series with the grid bias of a variable μ tube in the feedback loop. It may be desirable to introduce nonlinearity in the modulation signal circuit to counteract nonlinearity in the modulator if $|\mu\beta|$ is not much greater than unity.

• • •

DOOR OPENER



Supersonic squealer actuated from car dashboard emits h-f sound from exhaust pipe that is picked up by a microphone to operate garage door opener. The system is made by Vendo Company of Kansas City

STANDARD CRYSTALS

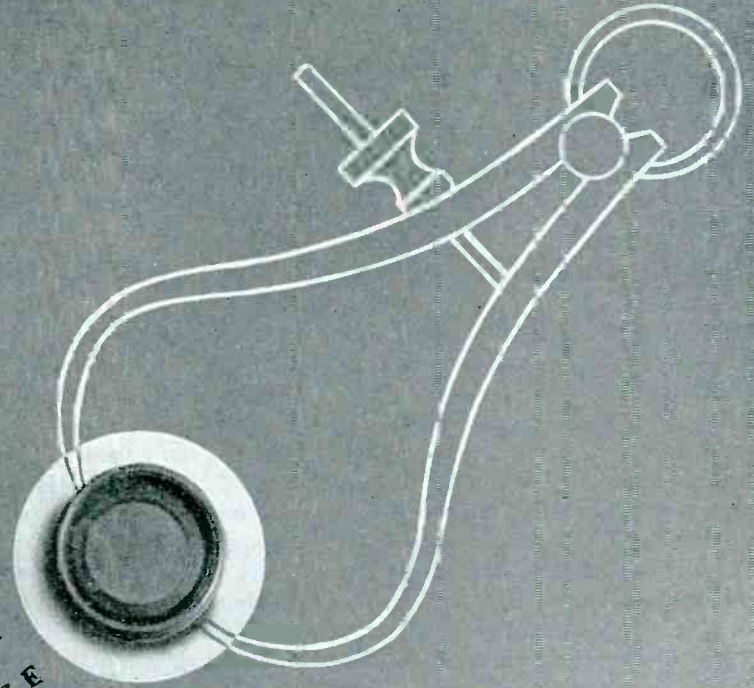

The *STANDARD MIDGET* can save you time, cost, space, weight, and circuit losses. It is easy to mount, is dust and moisture proof, corrosion resistant and withstands severe vibration.

There is a *MIDGET* type for your application; let us know your needs.

Regular *STANDARD* quartz crystals are also available to your specifications for all uses.

Send today for our new catalogue.

STANDARD PIEZO COMPANY

Established 1936

Quartz Crystals and Frequency Control Equipment

Office and Development Laboratory

SCRANTON, PA.

CARLISLE, PA., P. O. Box 164

CARLISLE, PA.

NEWS OF THE INDUSTRY

Commercial radar progress; f-m receivers; reports on dielectric heating and wire recording; three lists of agents for surplus electronic equipment

CAA Radar for Airways is Approved by British

AT A RECENT British Empire Radio for Civil Aviation Conference held in London recently, several important points of agreement were reached which indicated complete accord with the Civil Aeronautics Administration on standards of airways aids and future developments. The U. S. delegation, headed by the Honorable Charles P. Taft and including representatives of the Army, Navy, Coast Guard, Radio Technical Commission and CAA, was invited to serve as observers but stayed to become active participants in the discussions and decisions.

The most important items of agreement reached at the conference were:

(1) The adoption of CAA-developed vhf static-free communications for airport and approach control. The frequencies used will be in the band 118-122 mc. Sufficient radio-frequency channels have been made available to accommodate all airports so that there will be no interference between airport traffic control stations. At present, only 278 kc is available for airport traffic control, whereas the vhf band will permit 20 channels to be used for this purpose. It was agreed that radiotelephone should be used in lieu of radiotelegraphy, thus speeding up operation of traffic in close proximity to terminal airports.

(2) The vhf two-course visual radio range developed by CAA was adopted as the primary short-range navigation device. This type of range produces two visual courses at 180 degrees which may be projected along an airway. Sector identification is also provided which advises the pilot of his position relative to the station and whether he is approaching or leaving the station. The course indications are shown on a right-left instrument

on the instrument panel in the cockpit. Voice communication which provides weather and airway traffic control information is also obtained from the same facility. Several hundred of these facilities are now being installed on federal airways throughout the U. S.

(3) Radar techniques have been developed whereby a simple instrument on the panel of the airplane will provide a meter indication giving the number of miles to the radio range station or instrument landing localizer station to which the pilot is flying. CAA authorities regard this instrument as the most important use of radar in the cockpit to come out of the war.

(4) Use of radar search device to aid tower operators to monitor planes doing instrument approaches and to help in emergencies where plane equipment is not functioning or where the plane is not equipped with proper instruments. This is considered the most important

ground application to come out of the war.

(5) Adoption of CAA three-element landing system consisting of glide path, localizer, and marker beacon.

Electronic Weapons

TO CONTINUE RESEARCH and development of weapons like the proximity fuze, Army Ordnance has selected the National Bureau of Standards to establish such activities on a permanent basis. Several other devices have been in the works but details have not been revealed.

Not only will the bureau study the application of new scientific knowledge to war uses but it will also undertake to study peacetime uses for the knowledge gained in development of weapons. Located in a half-million dollar laboratory scheduled to be finished this year, the activities will center in the Ordnance Development Division headed by Harry Diamond. Several hundred physicists, engineers, and technicians will constitute the staff, set up to draw upon the facilities and experience of the entire National Bureau of Standards.

International RMA

MUTUAL PROBLEMS were discussed at the Second Joint Conference held recently between the U. S. and the Canadian RMA's. Held at the West-



Directors of the U.S. and Canadian RMA's get together at lunch during the recent Second Joint Conference in Rye, N. Y. See if you can find W. R. G. Baker of General Electric and George Lewis of IT&T

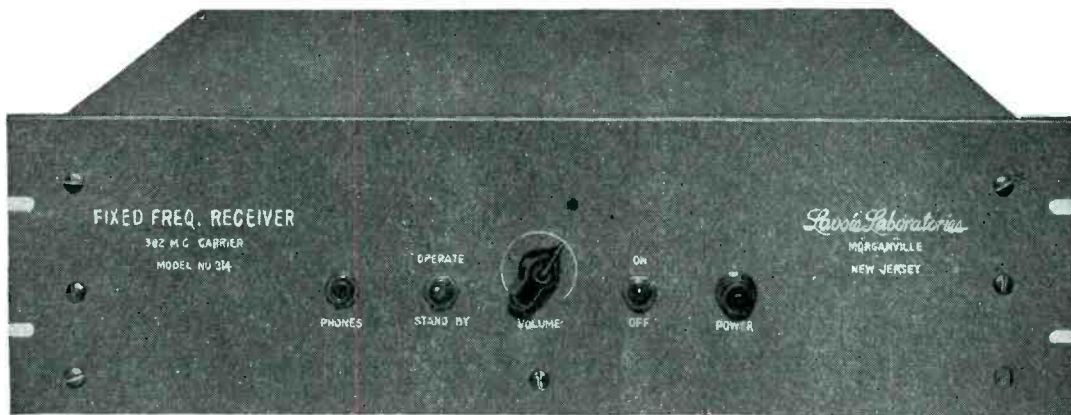
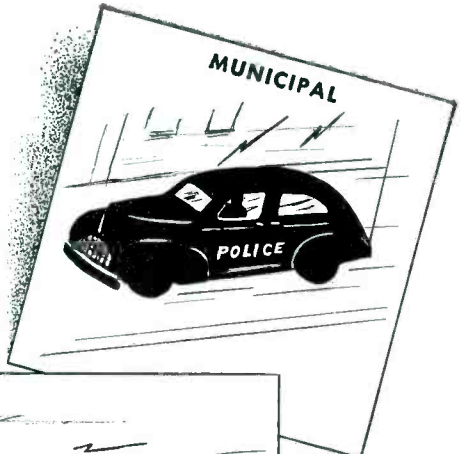
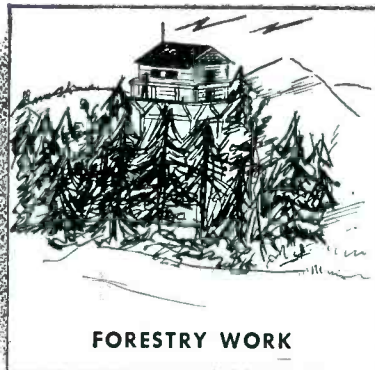

NEW! LAVOIE Fixed-Frequency Receiver for Applications Over 100 MC's

Designed for communications between air-plane and land; forestry service, police calls, fire, relay networks and other services operating at these frequencies.

Crystal-controlled oscillator circuit em-

bodies new, high-efficiency harmonic generator. Suitable for any frequency between 100 and 3000 megacycles **CUSTOM-BUILT** to your requirements.

In writing for quotations and details, please state general nature of service intended.



OTHER LAVOIE PRODUCTS: Frequency Meters—Frequency Standards—Receivers—Transmitters—Antennas and Mounts.

Lavoie Laboratories

**RADIO ENGINEERS AND MANUFACTURERS
MORGANVILLE, N. J.**

**Specialists in The Development of UHF Equipment
and in The Manufacture of UHF Antennas**

Glaser

SOLDER PRODUCTS

For Quality Products—use a Quality Solder



In Electronics "Quality" is vital! A lowering of "Quality" in any integral unit means shorter life and poor performance.

In close assembly and confined spaces, or where extremities of heat and cold reaction occur, the demand for a positive, lasting solder bond is imperative.

For that extra quality so essential to your capacitors, resistors, transformers, relays etc. use Glaser Rosin Core Solder—it is your guarantee of *dependable service*.

Electronic Engineers and Technicians appreciate the fine quality of Glaser Solders and Fluxes—the result of metallurgical research extending over a period of twenty-three years.

Use Glaser Solders and you'll understand why so many leading solder users in the field of electronics and radio speak of them in terms of the highest praise.

Consult our Engineering Department on your soldering and flux problems, without obligation.

GLASER LEAD CO., INC.

31 Wyckoff Avenue, Brooklyn 27, N. Y.



OTHER GLASER PRODUCTS

Silver Brazing Solder and Flux

Fluxes for every purpose.

Lead Products of every description.

Lead Lining of acid and plating tanks.

Glaser Rosin Core Solders exceed government specifications in purity, and are guaranteed to meet A.S.T.M. Class A specifications for solder.



R. C. Cosgrove explains an outside loop to associates from American and Canadian RMA's at Rye, N. Y. Others are A. B. Oxley, Montreal; R. A. Hackbush, Toronto; R. M. Brophy, president of the Canadian association; Bond Geddes

chester Country Club, Rye, N. Y., the meeting featured a luncheon and a reception at both of which prominent people from the radio industries of the two countries became better acquainted as shown in the accompanying illustrations.

Experimental Radar Licenses

A LIMITED NUMBER of experimental Class 2 licenses will be issued by FCC for compilation of data on operation of navigational radar devices — particularly information which might be useful in formulating regulations governing the operation of radar stations.

Channels have been designated above 25 mc specifically for radio aids to navigation but they are subject to change or modification necessitated by the results of the next World Telecommunications Conference. Applicants are being cautioned against this risk.

New F-M Circuit

COSTS FOR F-M receivers may be brought into line with those for a-m sets as a result of a new circuit revealed by Stuart M. Seeley of RCA Laboratories at a recent New York section meeting of IRE.

Insensitive to electrical interference of all kinds, the new circuit is a ratio detector. Not only is it free of a critical threshold signal level but its use in a receiver eliminates the need for special noise suppression stages which formerly increased costs of f-m receivers without adding anything tangible to their operation.

It was simultaneously announced

OUR 23RD YEAR OF DEPENDABLE SERVICE TO AMERICAN INDUSTRIES

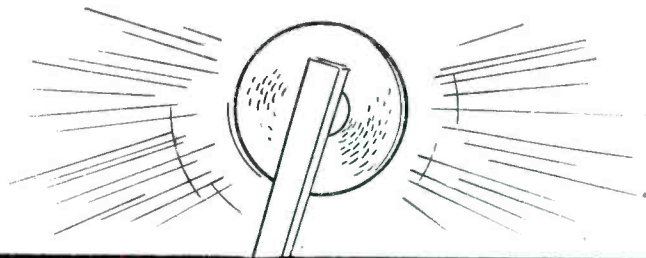

KLIXON Snap-Acting CONTROLS

RING THE BELL for reliable control or protection

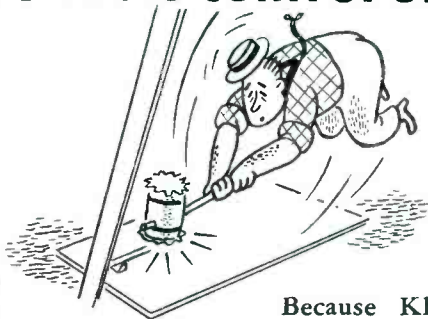

Because Klixon Snap-Acting Controls are simple, and foolproof with *no* complicated operating mechanisms, they always provide accurate control or protection in every application. Small, lightweight, compact, they fit into products without complicated design alterations. They operate surely and dependably even under shock, vibration, motion or altitude.

Use Klixon Controls in such applications as motor and transformer overheat protection, electrical circuit overload protection, thermal time delay or temperature control for radio equipment.

Klixon Controls are available in a wide range of standard types with ratings to meet practically every requirement. Write for complete information. And if you need engineering assistance, our engineers are available for consultation on your specific problems.

SPENCER THERMOSTAT CO., ATTLEBORO, MASS.



Type PM (NAF-1131) Circuit Breaker.

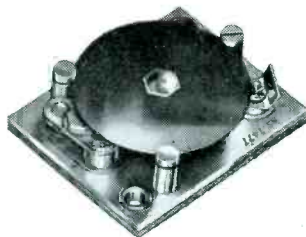

Type B-3120 Thermostat and Heater, Crystal Dew Point Control.



Type C-2851 Thermostat. For such use as Roughing Controls on Outer Crystal Ovens.

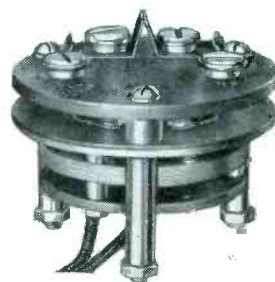

Type ER Series. Ambient Compensated Time Delay Relays.



Type C-7220 Precision Snap Switch 12 amps. 30 Volts D.C., 125 Volts A. C.

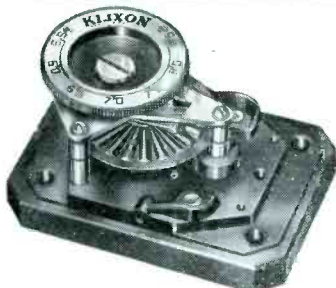

Type RT Thermostat. Adjustable Temperature Control.



Type C-4351 Thermostat. Used for Tube Warming, Tube Cooling, High Limit Controls, etc.

WANTED



CRYSTAL CLEAR RECEIVERS

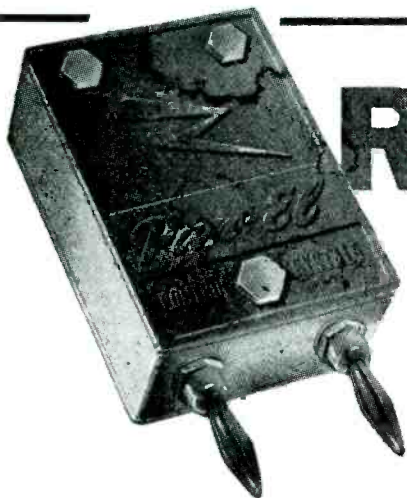

READY:

PAN-EL CRYSTALS

ELECTRONIC ENGINEERS now developing circuits for domestic receivers, or any other devices in which precise frequency-control is essential, will find helpful collaboration here. We are quantity producers of the most difficult crystals, and can meet your specifications as to frequency, quantity and delivery date.



PAN-ELectronics LABoratories, Inc.
500 SPRING STREET, N. W. ATLANTA, GEORGIA

Pan-El

QUANTITY PRODUCERS OF STANDARD AND SPECIAL

Control Crystals

by RCA Victor division of RCA that the development would be embodied in future models of f-m receivers produced by the company.

Radar Specifications

THREE TYPES of radar are covered in specification briefs sent by the U. S. Coast Guard to makers of electronic gear. The types are designated A, B, and C. Class A is the highest-definition equipment capable of giving early warning of approaching vessels and the best navigational assistance co-ordinated with racon (radar control of navigation) and identification beacons.

Class B will have less resolution and will operate only with the identification beacons, while Class C will comprise that equipment with such low resolution that it can serve only as anti-collision gear.

RMA Divisions

SPEAKER MANUFACTURERS within RMA have been transferred from the amplifier and sound equipment division to the parts division where a new speaker section has been established. Its chairman is George R. Haase, Operadio Co. A new speaker parts section has been started in the same division with A. D. Plamondon Jr., Indiana Steel Products Co., as chairman.

In the transmitter division the following section chairmen have been appointed: transmitter tube section, E. H. Fritschel, General Electric Co., Schenectady; broadcast transmitter section, C. W. Miller, Westinghouse Electric Corp., Baltimore, reappointed; marine section, R. E. Samuelson, Hallicrafters Co., Chicago; aviation section, F. C. McMullen, Western Electric Co., New York; emergency service communications section, H. F. Mickel, RCA Victor Division, Camden, N. J.; piezoelectric quartz crystal section, George E. Wright, Bileley Electric Co., Erie, Pa., reappointed.

FCC Against Interference

RULES AND REGULATIONS are being considered for promulgation by FCC to govern the design and operation of gear utilizing r-f energy for non-communication purposes. Medical diathermy and industrial heating equipment would be the

An Announcement

To Our Friends and Customers

After several years of research we are pleased to announce to our many friends and customers the completion of our Selenium rectifier development program.

We are proud to present **▶ Seletron ◀** an extremely highly stable selenium rectifier incorporating a metal alloy in conjunction with aluminum plates.

We are ready to accept orders for units up to 1000 ampere capacity with excellent delivery schedules. Your immediate inquiries for selenium rectifiers are solicited.

Literature upon request

RADIO RECEPTOR COMPANY, Inc.

Selenium Rectifier Division

251 WEST 19th STREET, NEW YORK 11, N. Y.

REPRESENTATIVES IN PRINCIPAL CITIES



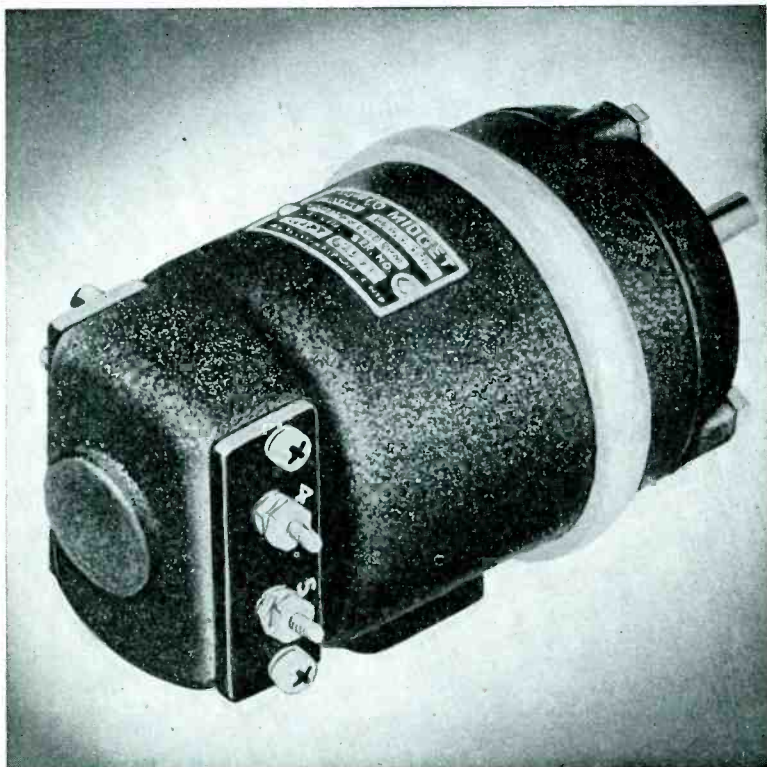

NEW

TYPE "FB" ELINCO

— MIDGET —

PRECISION FRACTIONAL HORSEPOWER MOTORS and GENERATORS

Type FB units are newly engineered to meet most exacting requirements for fractional horsepower motors and generators. Available as D.C. permanent-magnet generators or motors, D.C. shunt-wound, series-wound or split-field motors. D.C. motors can be wound to operate on voltages from 6 to 115 v. Also available in A.C. types as permanent-magnet generator wound to generate 2-pole single phase, 2 phase or 3 phase; as A.C. series motor with power supply up to 115 v., 60 cycles, single phase; also as universal series motor up to 115 v. Efficiency of motors as high as 45-60% on some applications.

Stainless steel shafts, aluminum die-cast housing finished in baked enamel. Overall dimensions 4" long (exclusive of shaft) by 2½" over flange. Designed for either base or flange mounting. Weight from 26 to 32 oz. according to type.

Complete performance data available on request.

ELECTRIC INDICATOR COMPANY
109 PARKER AVE. • STAMFORD, CONN.

primary target because they create serious interference particularly in congested city areas.

The commission has also announced its readiness to test for type approval, diathermy units designed to operate within the three frequency bands set aside for the purpose.

Industry Quadrupled

BECAUSE THE RADIO industry has grown to four times its size before the war it could satisfy the most extensive estimates of consumer demand within a year, believes James J. Nance, vice-president of Zenith Radio Corp. Speaking before the Sales Executives Club in New York recently he put the immediate pressing demand for receivers at 5 million and mentioned a normal replacement demand of 25 to 40 million. Production in the last pre-war year was 14 million.

Snowbound Engineers

ATOP THE 11,485 ft. Mount Gorgonio in Southern California this winter, engineers from Raytheon Mfg. Co. will operate equipment for testing the feasibility of permanent tele and radio relay stations there. Suitable buildings have been erected and the party will hole up for the season, supplied with the necessities of life by packhorse.

Dielectrics at Cedar Rapids

AT A RECENT meeting the Cedar Rapids Section of IRE heard R. F. Field, General Radio Co., present a paper titled, The Behavior of Dielectrics Over Wide Ranges of Frequency, Temperature, and Humidity. Accompanying his talk with slides, Mr. Field outlined the theoretical and mathematical aspects of the subject, and demonstrated that such behavior can be predicted to a first approximation when only a few parameters are known.

While it might be said that raising the temperature increases both dielectric constant and dissipation factor, Mr. Field showed that the correct statement is that increasing the temperature moves the curves bodily up the frequency scale. For any one temperature, a curve plotted against frequency reveals that the inflection point of the curve for dielectric constant occurs at the



Southern New England...
**BLUE BOOK OF
 AMERICAN INDUSTRY**

GET out your directory of manufacturers . . . check with any credit rating service . . . and you'll discover more leading industries with headquarters—or branches—in Southern New England than in any other part of the country.

For example, while you probably associate the name of General Electric with Schenectady, General Electric also has large plants here in Massachusetts. So have Cluett, Peabody; Westinghouse; Pullman.

As for American Optical, Simonds saws, Whitney carriages, American Woolen, Pro-phy-lac-tic brushes, M. J. Whittall rugs, and many more . . . they were native born.

These manufacturers did not pick Southern New England by chance.

They chose Southern New England because it was the most highly-industrialized area in the whole United States . . . and always has been.

Also, because Southern New England is in the heart of the great mass of America's consuming public.

Inside a radius of 500 miles from the center of Southern New England are 58,000,000 people to use Southern New England's consumer goods and her

vast output of producer commodities . . . the parts and tools upon which other industries depend to keep going.

And through her great seaports, Southern New England is only a step away from tidewater and easy access to the foreign markets that will develop now that the world is again at peace.

If your postwar plans are still in a state of flux, think hard about Southern New England . . . a great place to promote your new or expanding business . . . and a great place to live and play, too.

* * *

A full-color booklet is yours for the asking: "Southern New England For Tomorrow's Industry". Get your copy by writing to P. E. Benjamin, Manager of Industrial Development, The New Haven Railroad, 80 Federal Street, Boston 10, Massachusetts.

This is one of a series of advertisements presenting the industrial advantages of Southern New England.

THE NEW HAVEN R.R.

Serving SOUTHERN NEW ENGLAND with a network of rail and highway transportation that puts every manufacturer "ON THE MAIN LINE".

LOW PRESSURE FOR HIGH FIDELITY IN TONE QUALITY



ASTATIC PHONOGRAPH PICKUPS

• Astatic's increased manufacturing facilities are being taxed to capacity to meet the ever-increasing demand for Astatic Phonograph Pickups. Higher fidelity of recorded sound, made possible by low stylus pressure, offset head, reduced record wear, lower tracking error and other characteristics, make Astatic Phonograph Pickups favorites with a majority of leading manufacturers of phonographs, radio-phonograph combinations, record-changers and play-back equipment.

"You'll HEAR MORE
from Astatic"

ASTATIC Crystal Devices
manufactured under Brush
Development Co. patents.

THE
Astatic
ASTATIC CORPORATION
CONNEAUT, OHIO
IN CANADA, CANADIAN ASTATIC LTD., TORONTO, ONTARIO

same frequency at which the dissipation factor is a maximum.

A frequency range of sixteen decades will show that more than one such inflection point can occur. Different types of polarization are the explanation for this phenomenon, dipole polarization existing above 1 mc, and interfacial polarization at frequencies below 1 cps.

A plot of dielectric constant vs frequency for different temperatures reveals that there is no single dielectric with a zero temperature coefficient of dielectric constant and that no combination of dielectrics can yield a zero coefficient over



During a recent IRE meeting in Cedar Rapids this group of Navy students from Iowa State College looked on while Collins Radio Co. engineer Donald Jenkins demonstrated a communications transmitter

a sufficiently extended frequency range. The temperature coefficient is negative at high and low frequencies, positive in the middle region, and zero where the curves cross.

Placing a dielectric in high humidity causes the formation of an ionized conducting film of water on the surface. The surface resistance quickly drops to only a small fraction of its dry value. If the material is porous, water is absorbed which will maintain the surface film for long periods of time. The lowered insulation resistance increases the dissipation factor of a dielectric inversely with frequency.

In order to take measurements at frequencies in fractions of cycles per second, an indirect method is used which consists of measuring the charging current against time, with a steady applied voltage. Such a curve contains the same information as curves of dielectric constant and loss factor vs frequency.

Approximately fifty Navy and ci-

CONTACT DATA

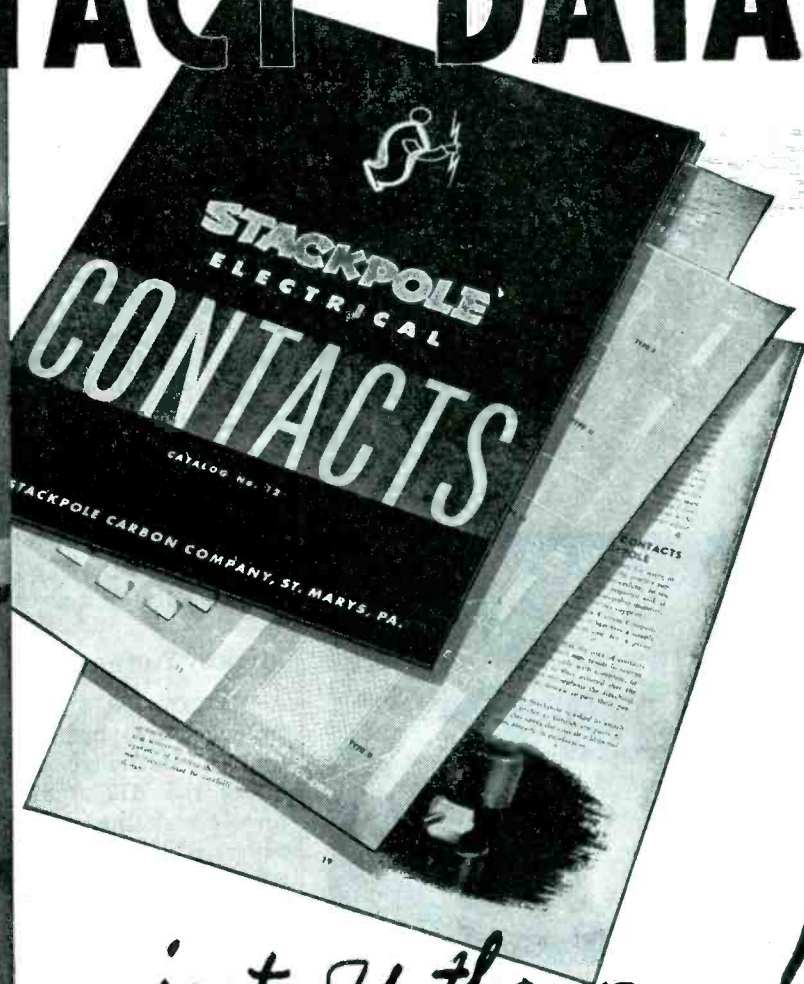

... just off the press!

If your product uses contacts you'll find in this new Stackpole Contact Catalog a wealth of information designed to help you select units for maximum service under all conditions of use. New contact developments described will prove highly important in the design of smaller, better post-war electrical equipment. Write today!

STACKPOLE CARBON COMPANY, ST. MARYS, PA.

**WRITE
FOR YOUR
COPY TODAY!**

STACKPOLE

BRUSHES and CONTACTS (All carbon, graphite, metal and composition types)
RARE METAL CONTACTS • IRON CORES • WELDING CARBON PRODUCTS
PACKING, PISTON AND SEAL RINGS • RHEOSTAT PLATES AND DISCS
BATTERY CARBONS • POWER TUBE ANODES • CARBON PIPE, ETC.

Designed for



Application

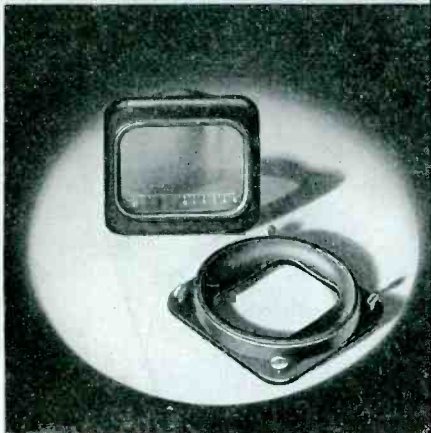

**THE NO. 80075 BEZEL
FOR
5" CATHODE RAY TUBE**

Another item in the Millen line of "Designed for Application" components. Bezel of cast aluminum with black wrinkle finish. Complete with neoprene cushion, green lucite filter scale and four "behind the panel" thumb screws for quick detachment from panel when inserting tube. Mounts in 5" diameter panel hole.

**JAMES MILLEN
MFG. CO., INC.**

MAIN OFFICE AND FACTORY
MALDEN
MASSACHUSETTS



vilian students at Iowa State College were guests at the meeting. During the day they were entertained by the Collins Radio Co., with a lunch and a tour of the plant. In small groups they were escorted on the tour by members of the Collins engineering staff who explained and demonstrated various Collins products.

New TBA Members

LATEST AFFILIATED member of TBA (Television Broadcasters Association) is Westinghouse Electric Corp., manufacturing division, Baltimore. C. J. Burnside is the official representative. Syracuse University and Western Reserve University have been added to the association's educational roster. They will be represented respectively by Kenneth Bartlett and Barclay S. Leathem. Yale and Rutgers already belong.

Mickey Network

A NATIONWIDE SYSTEM of airway traffic control has been visualized by L. A. DuBridge, executive director of the MIT Radiation Laboratory. Consisting of 200 mickey-type radars the network would cost about \$20 million.

Airways traffic controllers would be able under this arrangement to see all the planes in flight in their specified area—a 20- to 30-mile range. In the opinion of Dr. DuBridge, equipment of this type is well past the experimental stage.

Reviewed Wire Recording

DEVELOPMENTS IN WIRE recording were discussed by Hugh Davis of J. P. Seeburg Co. in a paper presented at the first fall meeting of the Chicago Section of the IRE. The subject is divided into three main heads: types of wire, recording heads, and mechanisms.

Round wires of stainless steel having diameters of 0.004 or 0.006 in. are in most common use; however, some recording is being done on flat tapes 0.002 by 0.008 in. In instances where cost is an item plated wires have been tried. Recording in parallel tracks on wide tape has been successful. Tape recordings, wound in pancakes, offer the advantage of indexing which is not possible with recordings on round wires. One German system

CENTRAL Electrical Papers

**FOR PRODUCT
IMPROVEMENT
LABOR AND MATERIAL
SAVINGS
EFFICIENT OPERATION
GREATER PROTECTION**

From light weight coil winding paper to heavy cable wrap, Central Electrical Papers are designed and built for the specific job they are to perform. Consult us on your Electrical Paper needs.

FREE BOOK

Contains information on all types of Central Electrical Papers and sample sheets for your inspection.

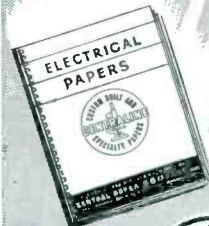

**CENTRAL PAPER COMPANY
INCORPORATED**

2442 LAKESHORE DRIVE, MUSKOGON, MICH.

OFFICES IN:

Boston, New York, Baltimore, Buffalo, Cleveland, Cincinnati, Detroit, Chicago, St. Louis, San Francisco

December 1945 — ELECTRONICS

Specify C-D MICABOND

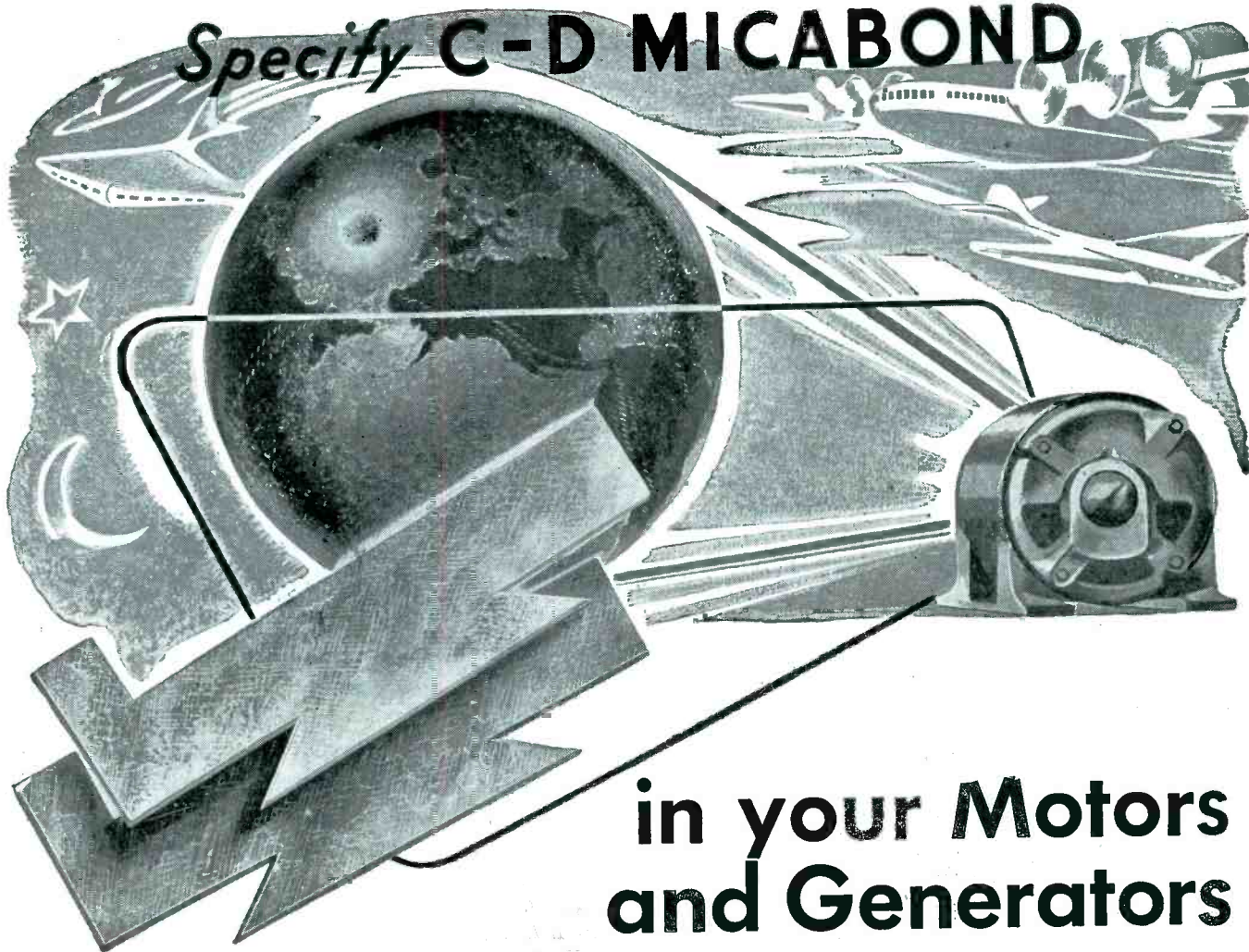

in your Motors and Generators

Ever stop to think how important electric generators and motors have become to "our" World? Practically every convenience we enjoy . . . the effectiveness of our War Effort . . . the assurance of a fully employed postwar World . . . depend on electric generators and motors.

C-D MICABOND . . . mica electrical insulation . . . helps keep these generators and motors running.

Generator and Motor manufacturers specify C-D MICABOND because it provides them with the "perfect insulation"—MICA—in usable forms. C-D MICABOND sheets, tubes, rings, segments and other shapes are provided by bonding mica splittings with insulating resins. For complete technical and mechanical data send for Bulletin "M".

DISTRICT OFFICES

NEW YORK 17 • CLEVELAND 14 • CHICAGO 11
SPARTANBURG, S. C. • SALES OFFICES IN PRINCIPAL CITIES

WEST COAST REPRESENTATIVES
MARWOOD LTD., SAN FRANCISCO 3

IN CANADA:
DIAMOND STATE FIBRE CO. OF CANADA, LTD., TORONTO 8

C-D PRODUCTS

The Plastics

DILECTO—A Laminated Phenolic.

CELORON—A Molded Phenolic.

DILECTENE—A Pure Resin Plastic Especially Suited to U-H-F Insulation.

HAVEG—Plastic Chemical Equipment, Pipe, Valves and Fittings.

The NON-Metallics

DIAMOND Vulcanized FIBRE

VULCOID—Resin Impregnated Vulcanized Fibre.

MICABOND—Built-Up Mica Electrical Insulation.

Standard and Special Forms

Available in Standard Sheets, Rods and Tubes; and Parts Fabricated, Formed or Molded to Specifications.

Descriptive Literature

Bulletin GF gives Comprehensive Data on all C-D Products. Individual Catalogs are also Available.

Continental - Diamond FIBRE COMPANY

Established 1895.. Manufacturers of Laminated Plastics since 1911—NEWARK 16 • DELAWARE

KX-45

Speed peacetime goods
to market with...

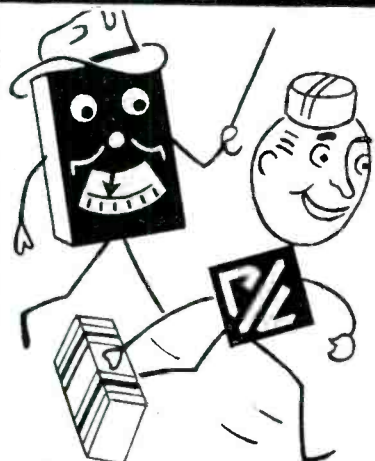

Clippard

**Electronic and Electrical
Test Instruments!**

Get off to a flying start without stops with Clippard precision laboratory or production instruments for electronic and electrical calibration, testing and inspection. Thirteen busy years experience. Sixteen separate types of instruments built for checking components and final testing of Navy V.T. proximity fuse! Routine production of parts for this project by the hundreds of thousands! What are YOUR laboratory or production instrument needs? Write Clippard for quotes, TODAY!

NEW!

A sturdy self-contained laboratory instrument, Weston metered, for calibration and test of A.C. meters and vacuum tube voltmeters. Highly accurate source of known voltage in 1/10 volt steps from 0 to 111, or in 1 to 1110 volt model. Engraved panel. Quartered oak case. Write for details.

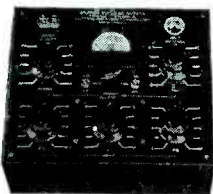

MR. SERVICEMAN: See Clippard's new line of rugged, versatile test equipment. Custom built, yet priced within reach of all who want instruments of laboratory caliber. Inquiries invited from those sincerely interested.

Electro-Magnetic Windings

R.F. Coils

Sub-Assemblies

Clippard

INSTRUMENT
LABORATORY

1440 CHASE AVE.

CINCINNATI 23, O.

made recordings on paper tape that had been sprayed with metal. A prime requisite of the wire or tape is that it be uniform.

For ease of loading, open type heads have been almost universally adopted. An improvement in fidelity is obtained by biasing the recording head with a high frequency current, usually about 50 kc. Biasing current is from 0.2 to 0.4 ma. Overbiasing has the effect of reducing the high frequencies and under biasing causes distortion. Erasing is done by increasing the biasing current to 20 ma.

Drive problems encountered are similar to those peculiar to disk recording at 33 1/2 rpm. Two feet per second for 0.004-in. round solid wire seems to be the minimum speed for good results. Stretching the wire either in recording or playback will modulate the recorded signal.

Behaviour of dielectrics over a wide range of frequency, temperature and humidity was discussed by Robert R. Field of General Radio.

F-M Receiver Design

ONLY THE 88 TO 108 MC band should be included in new designs of f-m receivers, according to Paul A. Porter, chairman of FCC. Writing to R. C. Cosgrove, president of RMA, Mr. Porter indicated that postwar f-m receivers should not be burdened with the cost of tuning provisions in the 42 to 50 mc bands.

As he pointed out, receivers built to a duplex design might very well retard the changeover from old to

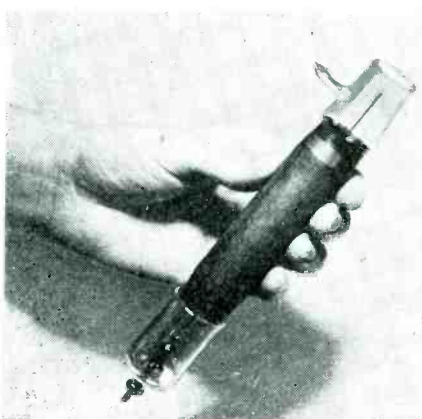

Closeup shows scale and conformation of Geiger-Muller tubes of a type made by North American Philips Co., Mount Vernon, N. Y. Units like these have been in the news recently as the testing elements of equipment used to check radiation at the craters of atom bomb explosions in New Mexico and Japan



**Ready
TO SHIP! . . .**

For prompt shipments of 3" Cathode Ray Tube Shields, specify "from Metallic Arts Company" when requisitioning from your purchasing department.

**MACO
SHIELDS**

have met the rugged tests of wartime uses . . . they're scientifically designed to do the job expected of them. Adapted for mounting directly on the panel. Functionally designed . . . easy to install . . . sure in operation. These 3-inch shields are made for the 3BP-1 Cathode Ray Tube.

For a complete line of stock sizes in Cathode Ray Tube Shields . . . or for specially designed shields to meet your specifications, write, wire or phone.



METALLIC ARTS CO.
243 Broadway
CAMBRIDGE 39, MASSACHUSETTS

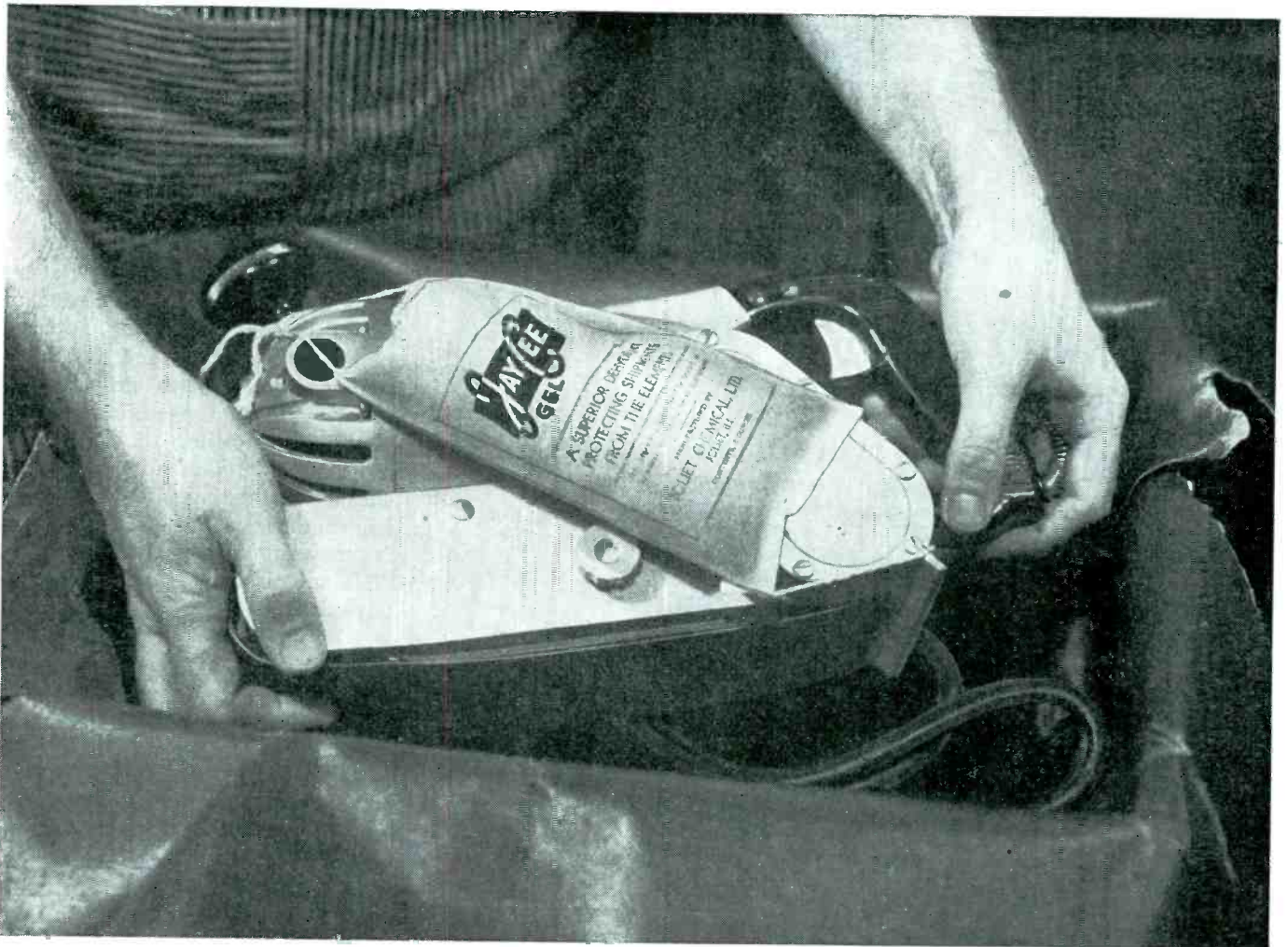

How SKILSAW Protects Equipment "in-the-Package"

Moisture "in-the-package" causes vast damage to precision equipment.

Skilsaw, Inc. prevents this damage by means of Jay Cee Silica Gel, the ideal drying agent. A few small bags of the Jay Cee Gel are included within tightly sealed packages of electric hand-saws, drills, and other tools. The gel has amazing power to absorb and hold moisture. Thus the air in the package is kept thoroughly dry and damage from rust or corrosion is avoided.

This practice is being followed by more and more manufacturers of metal products. The cost of the gel is a mere trifle in comparison with the

possible damage from rust or corrosion.

Jay Cee Silica Gel has wide application in the Air Conditioning, Refrigeration, and Chemical industries. It is clear white; passes a rigid section test; meets exacting Government specifications; is strictly a quality product.

A few excellent Jay Cee Silica Gel sales territories are still open to jobbers. Write for details.



JOLIET CHEMICALS, LTD., INDUSTRY AVENUE, JOLIET, ILLINOIS



SILICA GEL

A superior dehydrant

The Largest Family...



OF "UL" LISTED

Pilot Light Assemblies is only one of many advantages of the Gothard Line. Ask for the Gothard Catalog if you do not have one.

Consult Gothard Engineers on all of your special Pilot Light requirements for experienced recommendations.

Model No. 1142
for Neon Lamp
NES1 and Mazda
44, 313 and 1815

Gothard
MANUFACTURING COMPANY
2114 CLEAR LAKE AVENUE, SPRINGFIELD, ILLINOIS

EXPORT DIVISION: 25 WARREN STREET • NEW YORK 7, N. Y.



Gothard lights are an official requirement in the National All-Amateur Transmitter Contest

new band. The objective of FCC in allowing f-m stations to continue operation in the lower band was to prevent the loss of service to listeners who have not been able to convert or replace their receivers.

Conditional F-M Grants

BECAUSE MEN in the military service are confronted with particular difficulties in completing applications for broadcast facilities, FCC reminds that it has proposed to make conditional grants of f-m applications, affording the applicants a period of 90 days in which to file engineering details. However, since f-m channels cannot be reserved for future assignments, promptest possible submission of applications is advocated.

License Transfer

PUBLIC INTEREST underlies a new plan suggested by FCC for the transfer of licenses from one broadcaster to another. Under the plan the Commission and the seller would publish the terms and conditions of the proposed sale of broadcast facilities and the name of the prospective buyer who has met the seller's price. Other persons desiring to apply for the station would be invited to do so on the same terms and conditions. The Commission would consider all applications on their merits with a view to granting the transfer on the basis of public interest.

Another suggestion designed to improve FCC's transfer procedure will be recommended to Congress. This will be a yardstick for measuring the appropriate value of a station so the Commission's field of choice will not be unreasonably restricted because of sales of stations at artificially high prices.

MEETINGS TO COME

DEC. 12; AMERICAN INSTITUTE OF ELECTRICAL ENGINEERS; Mathematical Formulations for Linear Servomechanism Systems, by Charles F. Rehberg, New York University; Room 301, Pupin Hall, Columbia University; H. E. Farrer, AIEE Headquarters, 33 West 39 St, New York 18, N. Y.

JAN. 9; AMERICAN INSTITUTE OF

Intricate Fabricating

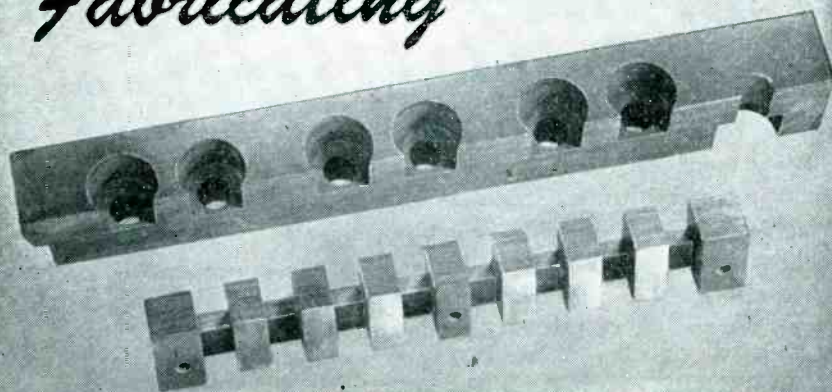

LET OVER TWENTY YEARS
OF EXPERIENCE GUIDE YOU

ELECTRICAL INSULATION CO., INC.

12 VESTRY ST., NEW YORK 13, N. Y.

FABRICATED PHENOLIC PARTS... SHEETS, RODS, TUBES

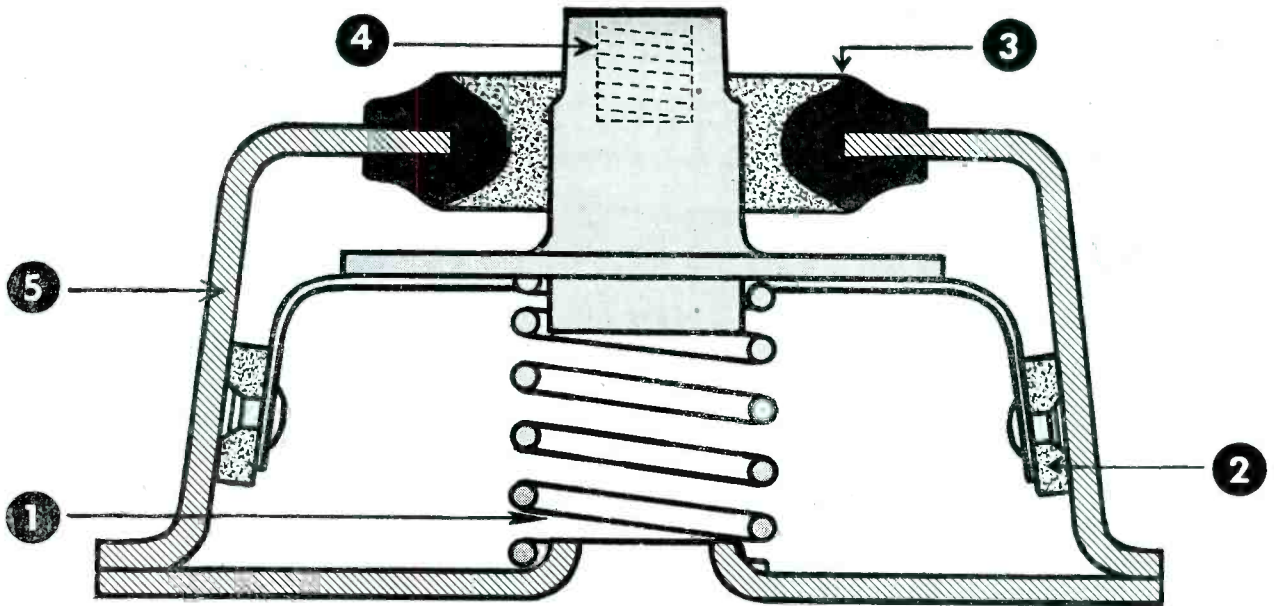

IT'S NEW

VIBRASHOCK* UNIT MOUNT

Amazingly Effective, Surprisingly Inexpensive



CHECK THESE OUTSTANDING FEATURES OF THE VIBRASHOCK UNIT MOUNT

- 1 Stainless steel spring provides complete three-way freedom in a *single unit*. (Conventional units are resilient in only one direction and must be assembled in tandem for horizontal absorption, requiring twice the normal quantity of mounts.)
- 2 Built-in damping mechanism kills low-frequency oscillation and minimizes resonance at critical frequencies. (No other unit mount has this outstanding feature.)
- 3 Built-in three-way shock assembly, complete with limiting disc and stud. (This is a saving to the user in both time and money, eliminating the necessity of installing washers, nuts and bolts.)
- 4 Rugged, load carrying central stud tapped for standard machine screws.
- 5 Sturdy, light-weight, metal housing having standard attachment holes in its base.

This combination of features assures outstanding performance in the first complete unit mount offered to Industry.

Robinson engineers offer a low-cost standardized Vibrashock unit mount that closely approaches the high operating efficiency of the famous custom-built Vibrashock Dual Suspension.

Without sacrificing the proven basic Robinson principle of three-way vibration absorption, the new unit mounts are simple, rugged and long-lived. Comparative tests show marked improvement in performance over conventional type unit mounts.

The use of stainless steel springs, instead of rubber or synthetic, eliminates drift or permanent set and

vulnerability to cold, heat or humidity.

Check your equipment—airborne, vehicular, mechanical — on these triple action mounts. The results are startling. (On one such application, electronic tube life has been increased from ten days to ten months.)

Vibrashock unit mounts are available in three sizes, and in a wide range of load ratings. Designers, engineers and purchasing agents will find in our new catalog "Vibration Control Engineered by Robinson," the answer to most vibration problems. Send for your copy of this new publication today.

*Trade Mark

ROBINSON AVIATION, INC.

Teterboro Air Terminal
Teterboro New Jersey
3757 Wilshire Blvd.
Los Angeles 5, California

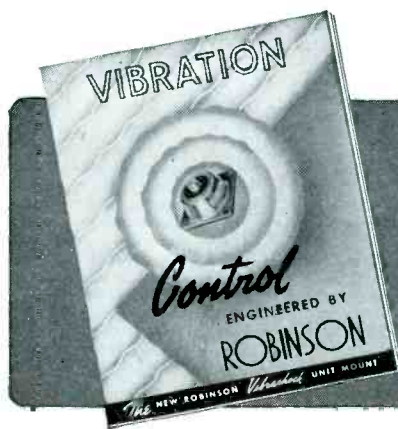

ROBINSON AVIATION, INC.
Teterboro Air Terminal, Dept. E
Teterboro, New Jersey
Gentlemen:

Please send me your catalog on the new Vibrashock Unit Mount.

Name _____

Company _____

Address _____

HARVEY

now has for delivery
long awaited

PRESTO PRODUCTS

As the supply situation relaxes, HARVEY can supply more and more famous radio and electronic components and equipment, such as the dependable Presto recorder and transcription playback described below. Avail yourself of our rapidly growing stocks, our fast, efficient service, our technical know-how! Get the equipment you need now by placing your order promptly.

PRESTO Model "K" RECORDER

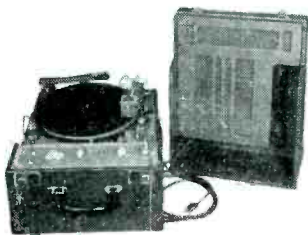

A portable sound recorder, record player and public address system. Complete in a single carrying case.

The Model "K" records 15 minutes continuously at 33 1/3 RPM on side of 13 1/4" disc. It also makes 6, 8, 10, and 12 inch records, and plays all makes of phonograph records. With its many exclusive features found in no other low priced recorder, the user is able to make high quality recordings consistently, reducing spoilage cost of discs and needles. As a voice amplifying system, it serves audiences of about 500 persons.

PRESTO Model "L" TRANSCRIPTION PLAYBACK



For those who demand "something better" in portable reproducing equipment. Small, light weight, easy to operate.

Its extreme simplicity and remarkably clear, wide range reproduction have made the Model "L" a favorite of radio stations, advertising agencies and program producers. It consists of a 12" dual speed rim-driven recording turntable, a 16" pickup on a swivel mounting which folds into the case when not in use, a 4 1/2 watt amplifier and an 8" loudspeaker, mounted in a single case. The speaker mounted in the case cover is equipped with a 20' extension cable. Semi-permanent needle supplied as initial equipment.

Telephone Orders to LO 3-1800

HARVEY
RADIO COMPANY
HARVEY
 103 WEST 43rd ST., NEW YORK 18, N. Y.

ELECTRICAL ENGINEERS; Transient Analysis of Linear Servomechanisms, by John R. Ragazzini, professor, Columbia University; Room 301, Pupin Hall, Columbia University; H. E. Farrer, AIEE Headquarters, 33 West 39 St, New York 18, N. Y.

JAN. 18-FEB. 7; GARDNER DISPLAY CO., Products of Tomorrow Exposition; Coliseum Group, Chicago, Ill. Marcus Hinson, general manager planning department, Armory, 16th and Michigan, Chicago.

JAN. 23-26; INSTITUTE OF RADIO ENGINEERS, 33d Annual Winter Technical Meeting; Astor Hotel, New York, N. Y.; E. J. Content, chairman of meeting committee, WOR, 1440 Broadway, New York 18, N. Y.

FEB. 4-7; AMERICAN WELDING SOCIETY, National Meeting; Hotel Cleveland, Cleveland, Ohio; M. M. Kelly, secretary, 33 West 39 St., New York 18, N. Y.

FEB. 4-8; AMERICAN SOCIETY FOR METALS, National Metal Exposition; Public Auditorium, Cleveland, Ohio; W. H. Eisenman, secretary, 7301 Euclid Ave, Cleveland 3, Ohio.

FEB. 6-8; AMERICAN INDUSTRIAL RADIUM & X-RAY SOCIETY, Annual Convention; Hollenden Hotel, Cleveland, Ohio.

FEB. 13; AMERICAN INSTITUTE OF ELECTRICAL ENGINEERS; Frequency Spectrum Theory Applied to Servomechanisms, by E. B. Ferrell, Bell Telephone Laboratories; Room 301, Pupin Hall, Columbia University; H. E. Farrer, AIEE Headquarters, 33 West 39 St., New York 18, N. Y.

FEB. 25-MAR. 2; INTERNATIONAL EXPOSITION Co., 20th Exposition of Chemical Industries; Grand Central Palace, New York; Charles F. Roth, manager, Grand Central Palace, New York 17, N. Y.

FCC ACTS

To permit:
U-Dryvit Auto Rental Co.
Boston, Mass.

To do this:
Install three portable and portable-mobile stations in vehicles to establish cost of service in use of rented radio-equipped trucks. Federal Telephone & Radio Corp. gear will be used on f-m at 50 w. Frequencies will be assigned.

RCA
Construct and operate four new experimental Class 2 portable radio

... INSTALL A PHOTOX

Photographic Silk Screen
Stencil Department for
marking and decorating
your products!

The PHOTOX Process is the only process that guarantees exact reproduction of one-color or multi-color jobs in either line work or halftone!

- It is practical on any printing surface - can be successfully used on paper, metal, wood, rubber, glass, plastic, textiles, etc.
- There are few size or contour limitations - makes possible marking in corners and on irregular contours that cannot be marked by machine.
- Preparation and operation are simple - unskilled workers easily taught the preparation and operation of the PHOTOX Process.
- The PHOTOX Process is economical - art work preparation cost is considerably decreased; plate-making cost is eliminated.

Let us show you how a PHOTOX Photographic Silk Screen Stencil Department can mean greater efficiency and greater profits for you. We are prepared to aid you in installing a PHOTOX Marking Department in your plant. Write for further details or personal consultation.



PHOTOX

SILK SCREEN SUPPLY CO.

Manufacturers of PHOTOX
Photographic Film and Silk
Screen Accessories.

30 IRVING PL., NEW YORK 3, N. Y.

ELECTRONIC A.C. VOLTAGE REGULATORS

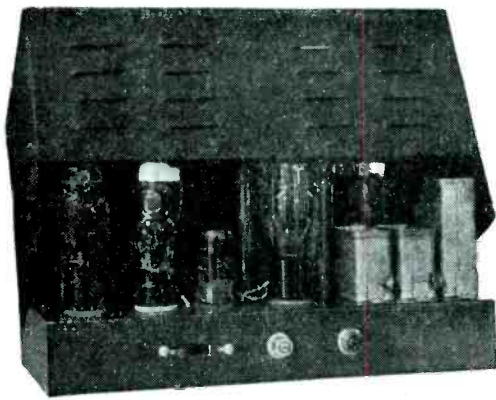

Model 250

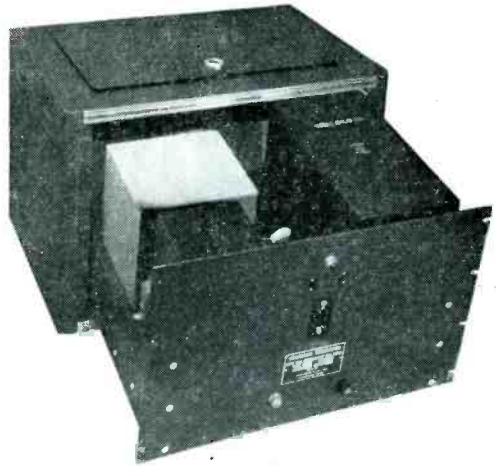

Model 1750

AVAILABLE FOR IMMEDIATE DELIVERY:

Model No.	Load Range
250	25 to 250 V.A.
1000	200 to 1000 V.A.
1750	800 to 2000 V.A.
5000	1000 to 5000 V.A.

NOTE THESE FEATURES:

- Output voltage maintained to within $\pm .2\%$ (adjustable 110-120 volts) with input fluctuations 95 to 130
- Output voltage constant to $.2\%$ despite variations in load over entire rated range of unit
- Minimum wave form distortion—about 5% average
- Independent of load power factor
- Independent of frequency variations $\pm 15\%$
- Quick response time—output voltage stabilized in SIX cycles maximum
- Built for long, trouble free service. Component parts conservatively rated—transformers, etc. hermetically sealed

For additional information and prices, write the factory or our Sales Representative nearest to you.

East Coast
BURLINGAME ASSOCIATES, LTD.
11 PARK PLACE
NEW YORK CITY

Middle West
ALFRED CROSSLEY ASSOCIATES
549 WEST RANDOLPH STREET
CHICAGO, ILLINOIS

West Coast
N. B. NEELEY ENTERPRISES
7422 MELROSE AVE.
HOLLYWOOD, CALIF.

SORENSEN & COMPANY, INC.

AIRBORNE ELECTRONICS

STAMFORD, CONN.

Useful TOOLS

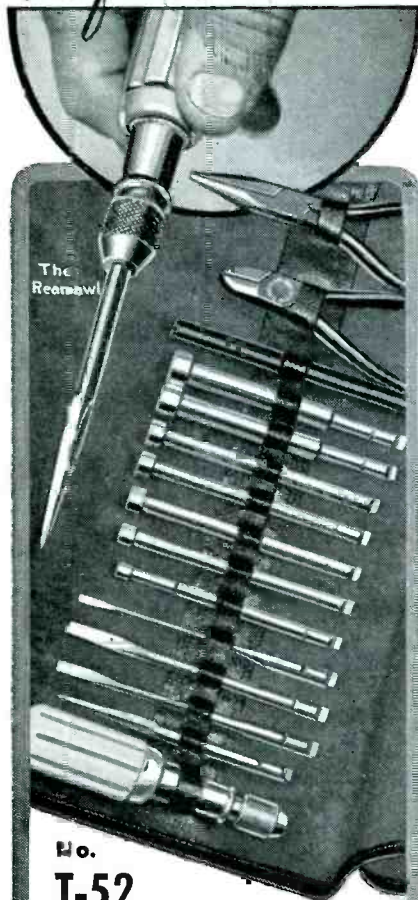

No.

T-52

SPINTITE SET.

Chuck Type Handle with Reamawl, 3 Screw Drivers, 7 SPINTITES, Insulated Neutralizing Alignment Wrench, and 2 Pliers, all in a Leatherette Roll. . . .

A Positive need in every RADIO, HOME and ELECTRICAL SHOP.

A Fascinating, Fast-Moving Item for thousands of stores.

Your good jobber has it. . .

Send for Catalog No. 141 picturing a full line of Automobile, Aircraft and Radio Tools.

WALDEN
WORCESTER
WRENCHES

STEVENS WALDEN, INC.

468 SHREWSBURY STREET

WORCESTER, MASSACHUSETTS

stations for testing a system of wide-band multi-channel radio communication between Philadelphia⁴ or Camden, N. J. and New York City with intermediate relay stations to be located in Bordentown, N. J. and Tenmile Run, N. J. Frequencies will be assigned; power 1 w, and emission, A0, A1, A2, A3, A4 and Special.

University of Chicago
Chicago, Ill.

Install a new experimental portable mobile radio station aboard a free balloon for operation within a 350-mile radius of Chicago. Objective is to transmit information on the nature of penetrating radiations in the stratosphere. Transmitters will be frequency modulated by impulses produced as a result of high-energy particles passing through a set of coincidence-counter tubes in a cosmic ray telescope. Frequencies will be assigned; power, 2 w; and emission special for radiosonde purposes.

Tanner Motor Livery, Ltd.
Pasadena, Calif.

Temporarily operate one experimental Class 2 land station and two portable mobile stations in taxicabs. Frequencies will be assigned; power, 30 w; emissions A1, A2 and A3.

WIBU
Poynette, Wis.
AT&T

Install new vertical antenna and change ground system. Install an additional 339-mile link in the proposed New York to Los Angeles coaxial cable extending from Meridian, Miss. to Shreveport, La. at a cost of \$7,056,000.

BUSINESS NEWS

AMERICAN PHENOLIC CORP. in Chicago is erecting a three-story building to house their expanding manufacture of plastic items for the electronic trade and other industries.

AIREON MFG. CORP. paid \$400,000 for 100 percent of the stock in Oxford-Tartak Co. and Cinaudagraph Corp., Chicago, Ill.

WILMOTTE LABORATORIES opens a branch laboratory at 236 W 65 St., New York 19, to provide complete engineering service in the application of electronics for industrial uses.

UTAH RADIO PRODUCTS Co., Chicago, and Universal Cooler Corp., Marion, Ohio, have merged into International Detrola Corp. The merger unites companies with a total of nine manufacturing plants in this country and two in Canada, making home and auto radio receivers, loudspeakers, other radio parts, refrigerators and furniture cabinets.

THE MUTER Co. of Chicago has acquired all capital stock of the Rola Co. in Cleveland. Larry King, formerly with Operadio, will be president and general manager of the Rola Co., to be operated as a division of the Muter Co. Ben Engholm,

QUALITY PLASTIC PARTS

PRECISION-MADE TO YOUR EXACT SPECIFICATIONS



Here is a dependable source for quality special parts or products fabricated from plastic sheets, tubes and rods. No matter how complicated your requirements may be, you can count on Sillcocks-Miller specialists to deliver accurate work to meet your most exacting specifications. You'll find it costs you less to pay a little more for Sillcocks-Miller quality.

Write for Illustrated Booklet describing helpful 4-way service

THE SILLCOCKS-MILLER CO.

10 West Parker Avenue, Maplewood, N. J.

Mailing Address: South Orange, N. J.

Specialists in High Quality, Precision-Made Plastics Fabricated for Commercial, Technical and Industrial Requirements

Good News for Research Men

Research Departments of some of America's great industries have called upon Jerome Engineering Company to develop specialized photographic equipment. We are prepared to offer this same service in Design, Development and Production to your Engineering problems. Here illustrated are some of the units which we wish to present in present or modified form. These are:

- (1) Automatic Impulse Camera, 35 and 70 mm. for Electronic Research. Has many uses.
- (2) Automatic Photographic Processing Machine.
- (3) Microfilm Filing Camera, for reducing diagrams, drawings, and engineering data to a card filing system.
- (4) Portable Recording Camera for remov-

- able instrument panels.
- (5) Low-Priced Copy Camera, for engineering data and sketches. Takes copy up to 10" x 14". Has own built-in illumination.
- (6) Universal Projector, for motion picture and still projection. Has remote control and viewing or editing screen.
- (7) Oscilloscope Camera, for recording oscilloscope traces, etc.

In photographic research and design, experience counts as in other branches of engineering. If you have need for specialized photographic equipment—HAVE IT ENGINEERED BY JEROME.

35 mm. Automatic Data Recording Interval Still and Motion Picture Camera, for time-lapse photography.

Heavy-Duty Professional Tripod — Built-in Heater for low-temperature work, if desired. Fast and controlled slow panoramic and elevation sweep.

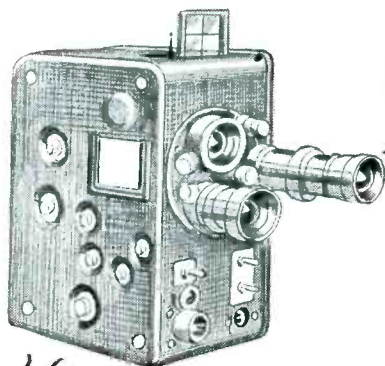

Massapequa

Jerome Engineering Company

MERRICK & HICKSVILLE RDS.
PHONE. MASSAPEQUA 2100

Long Island N.Y.

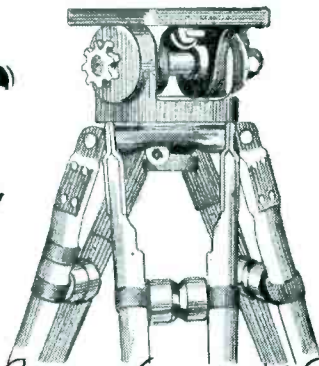

Specify DRAKE for Better Dial Light Assemblies

THE Dial Light Assembly of the number 500 U Series illustrated here, is one of the outstanding units of the widely known DRAKE No. 500 Series. The legs of the bracket are made in various lengths, from 27/32" to 1-7/16" from base to shoulder. This unit will fasten on any panel from 0 to .062 thick. When specifying Dial Light Assemblies, remember millions of DRAKE 500's have been used since 1940! These units are TIME-TESTED . . . offer you all the superior advantages developed through years of highly specialized experience in designing and manufacturing Dial and Jewel Light Assemblies *exclusively*. Extensive facilities for high speed production bring you better quality at low cost. Is the newest catalog listing the complete DRAKE line at your finger tips, NOW?

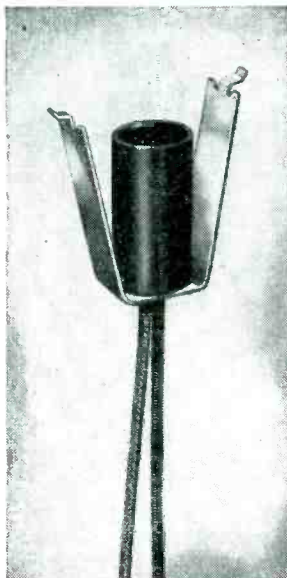

No. 542 U-43 . . . the unit shown above, has 1-5/16" legs built for .043 panel. Prompt shipments assured in large quantities for your production line requirements.



SOCKET AND JEWEL LIGHT ASSEMBLIES

DRAKE MANUFACTURING CO.

1713 WEST HUBBARD ST., CHICAGO 22, U.S.A.

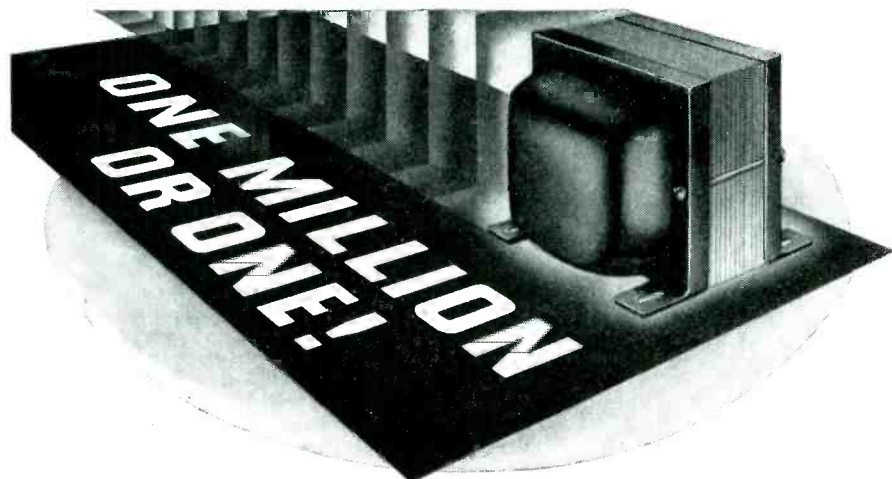

Electronic Engineering can supply—NOW—transformers in standard or special styles in *Any* quantity . . .

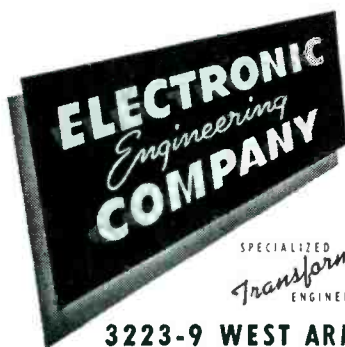

SPECIALIZED
Transformer
ENGINEERS

Because there have been no conversion problems at Electronic Engineering, we are now producing and delivering the *finest* transformers with the same speed and skill as during the war. We are ready to serve your needs . . . with one million or one!

3223-9 WEST ARMITAGE AVE. • CHICAGO 47, ILLINOIS

former president and principal stockholder of Rola, will remain in a consulting capacity.

WESTERN ELECTRIC Co. has purchased a 40-acre tract in Allentown, Pa., for a new electronic components plant that will provide employment for about 1,500 people. Present plans call for production of vacuum tubes, quartz crystals, temperature-sensitive devices, and other precision products for use in the Bell system and in other commercial applications. The manufacturing areas will be fully air conditioned.

HOFFMAN RADIO CORP., Los Angeles, has formed a new CAA Division that will develop material built to specifications of the Authority. In charge will be Elmer P. Gertsch, formerly manager of the Radio Division for Air Associates, Inc.

GILFILLAN BROS. INC., West Coast manufacturer and co-developer with MIT of the famed GCA (described in the Nov. 1945 *ELECTRONICS*, page 112) staged the first public demonstration, at Los Angeles Municipal Airport, of this radar system for



Lt. Col. Harry Downing, commanding officer, Mines Field, California, and S. W. Gilfillan, president of Gilfillan Bros. Inc., standing before the trailers housing the military version of GCA. The rotating radar antenna is mounted in the curved housing atop the trailer

guiding planes to safe landings through storm, fog and darkness. Gilfillan is now entering full-scale manufacture of GCA equipment as converted to civil uses for landing fields.

SENTINEL RADIO CORP. has broken ground for a modern plant at a location in Evanston, Ill., occupying over nine acres. It will have an estimated production capacity of 3,000 radio sets per day on a single-

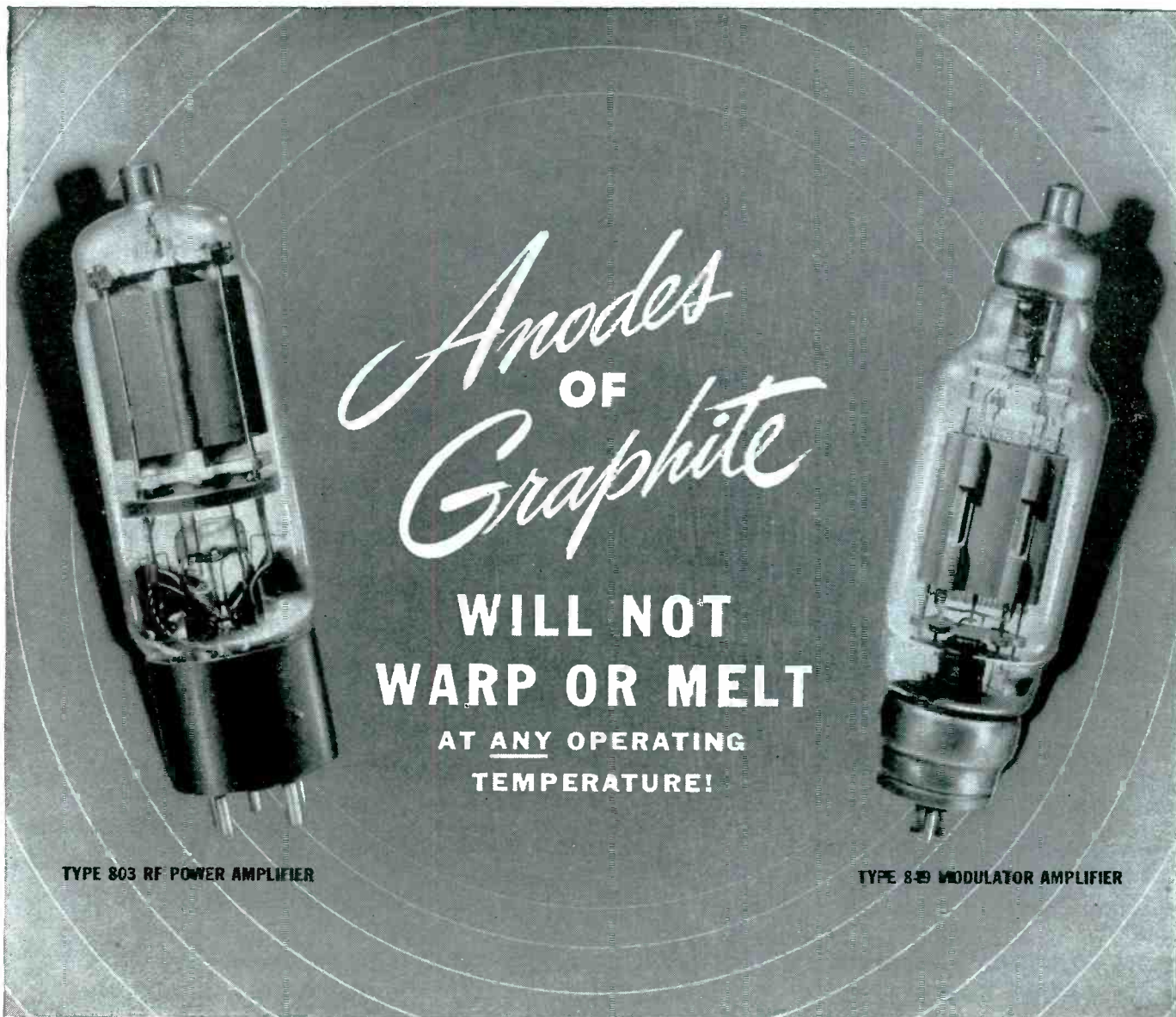

TYPE 803 RF POWER AMPLIFIER

TYPE 849 MODULATOR AMPLIFIER

Anodes OF Graphite

**WILL NOT
WARP OR MELT
AT ANY OPERATING
TEMPERATURE!**

HERE is a significant fact for electronic engineers: No other material can withstand extremely high temperatures like graphite. In fact, graphite *has no melting point!* This means that anodes made of graphite will retain their shape better—will not fuse or warp or melt—no matter how high the manufacturing or operating temperatures.

"National" graphite anodes, because of their higher thermal emissivity, will operate at lower temperature for a given amount of energy dissipated. Result: a lower operating temperature

for all tube parts and therefore less distortion and more uniform tube characteristics.

Moreover, "National" graphite used in making anodes has much greater strength, finer grain structure, smoother machined or machinable surfaces, and greatly increased erosion resistance.

Why not investigate further the promising possibilities in using graphite for your anodes? National Carbon Company, Inc., a pioneer in developing carbon and graphite products, looks forward to the opportunity to work with you.

The word "National" is a registered trade-mark of National Carbon Company, Inc.

NATIONAL CARBON COMPANY, INC.

Unit of Union Carbide and Carbon Corporation



General Offices: 30 East 42nd Street, New York 17, N. Y.

Division Sales Offices: Atlanta, Chicago, Dallas, Kansas City, New York, Pittsburgh, San Francisco

HUDSON AMERICAN TRANSFORMERS

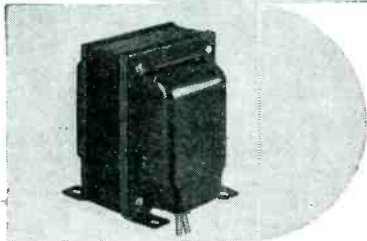
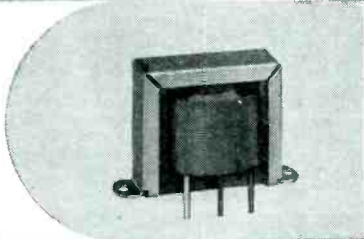
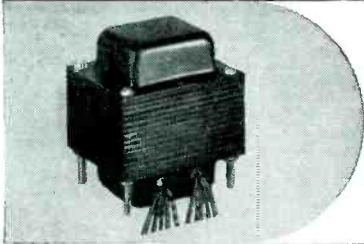

FOR GENERAL ELECTRONIC AND RADIO APPLICATIONS

HUDSON AMERICAN'S 20 years engineering experience has developed 6 outstanding points of perfection in the manufacture of high quality Transformers:

- 1 Most modern coil producing machinery available.
- 2 Vacuum impregnating equipment for wax or varnish.
- 3 Completely automatic production test equipment.
- 4 Precise winding and meticulous assembly.
- 5 Thorough impregnation and careful finishing.
- 6 Maximum uniformity.

Specify HUDSON AMERICAN TRANSFORMERS for your radio and electronic requirements.

Write for catalog 1045



**HUDSON
AMERICAN
CORPORATION**

A subsidiary of Reeves-Ely
Laboratories, Inc.

25 WEST 43rd STREET, NEW YORK 18, N. Y.

shift schedule. Production lines 300 ft long will be fed direct from the receiving department at the west end of the building and will turn

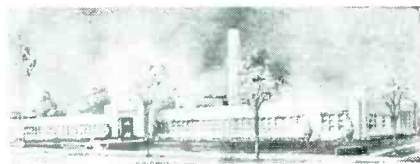

Architects' sketch of new Sentinel plant

out completely tested radio sets packed and ready for shipment at the east end of the building.

COMMUNICATION PARTS recently purchased a new plant in Chicago having unique features. Each work bench is an illuminated and wired unit in itself yet all benches can be linked together in a few minutes for a line assembly operation.

WAVEGUIDE ELECTRONICS, 30 Church St., New York, is an organization of men who have been installing radio and radar gear on Navy vessels. The new company has facilities for fabrication and installation of waveguides and coaxial transmission lines, and plans to concentrate on installation and servicing of electronic radio and radar equipment on ships, in plants, at airports, etc.

SYLVANIA ELECTRIC PRODUCTS INC. produced more than 140 million tiny tubes and millions of fuzes for the Navy's secret VT proximity fuze program, also known as "Project A". The eight plants engaged in this work received 22 special awards from the Navy Bureau of Ordnance for efficient production.

PERSONNEL

WM. D. MACGEORGE, formerly chief of the Electronics Laboratory at Baldwin-Southwark, joins the staff of Automatic Temperature Control Co. in Philadelphia as technical consultant concerned with development of automatic control instruments.

J. WESLEY KOCH, until recently a captain with the office of the Chief Signal Officer in Baltimore, is now on the engineering staff of Mutual Broadcasting System. While in the Army, he served as technical adviser of the Radio Propagation Unit and as staff radio officer in North Africa and Italy.

EARL MINOR JOHNSON, radio propagation specialist with the War De-

**YOU NAME IT,
WE'LL SUPPLY IT**



EVERYTHING IN RADIO AND ELECTRONICS

R. W. T., world's oldest and largest Radio Supply House is ready again with tremendous stocks of sets, parts and equipment. You can depend on our quarter-century reputation for quality, sound values and super-speed service. Orders shipped out same day received. All standard lines already here or on the way, including: National, Hammarlund, R. C. A., Hallcrafters, Bud, Cardwell, Bliley and all the others you know so well.

Originators and
Marketers of
the Famous

Lafayette Radio

Radio Wire Television Inc.

100 Avenue of the Americas, New York 13
(Formerly Sixth Avenue)
Boston, Mass. • Newark, N. J.

"No supplier anywhere has a bigger stock of Radio and Electronic equipment, Test equipment, Public Address equipment, Communications equipment. If your engineering problem requires special equipment, we'll make it. Write today Dept. EL5."

CRONAME *Facilities*

FOR ELECTRONIC COMPONENTS
AND FINE METALCRAFT

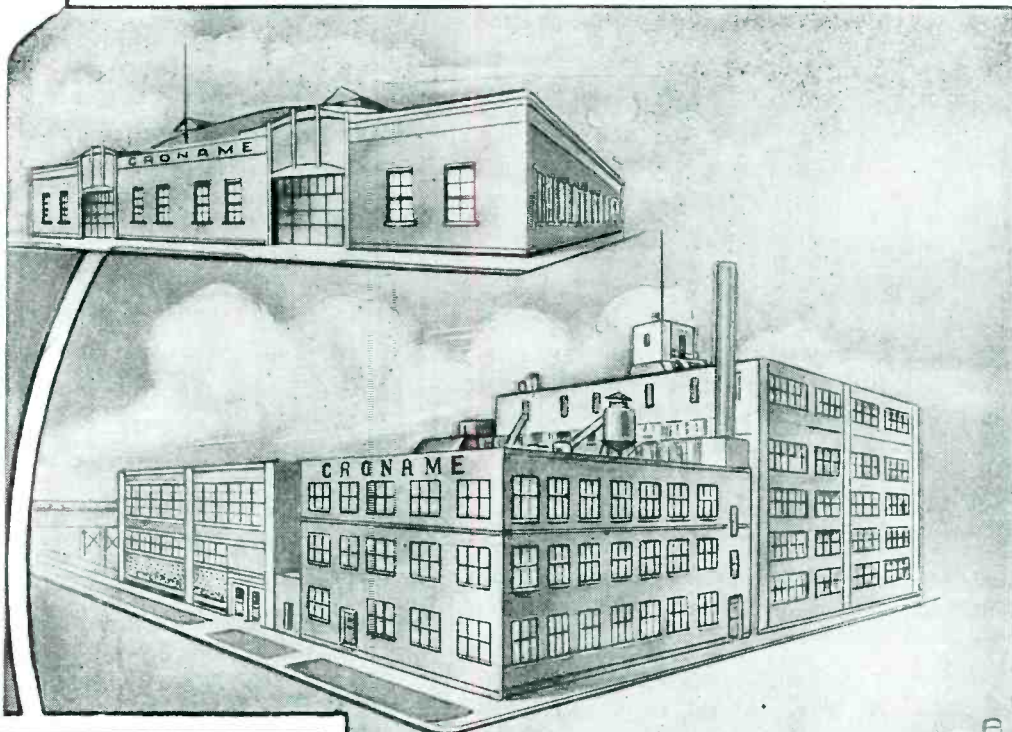

ENGINEERING
ETCHING
LITHOGRAPHING
EMBOSSING
ENGRAVING
STAMPING
ALUMINUM WELDING
& HEAT TREATING
ASSEMBLIES
SOLDERING
METAL FINISHING
PLATING

ANODIZING
PARKERIZING
OXIDIZING
FLUORESCENT
PHOSPHORESCENT
DECORATED GLASS
GLASS DIALS
DECORATED PLASTICS
FORMED PLASTICS
RADIO TUNING UNITS
REMOTE CONTROLS

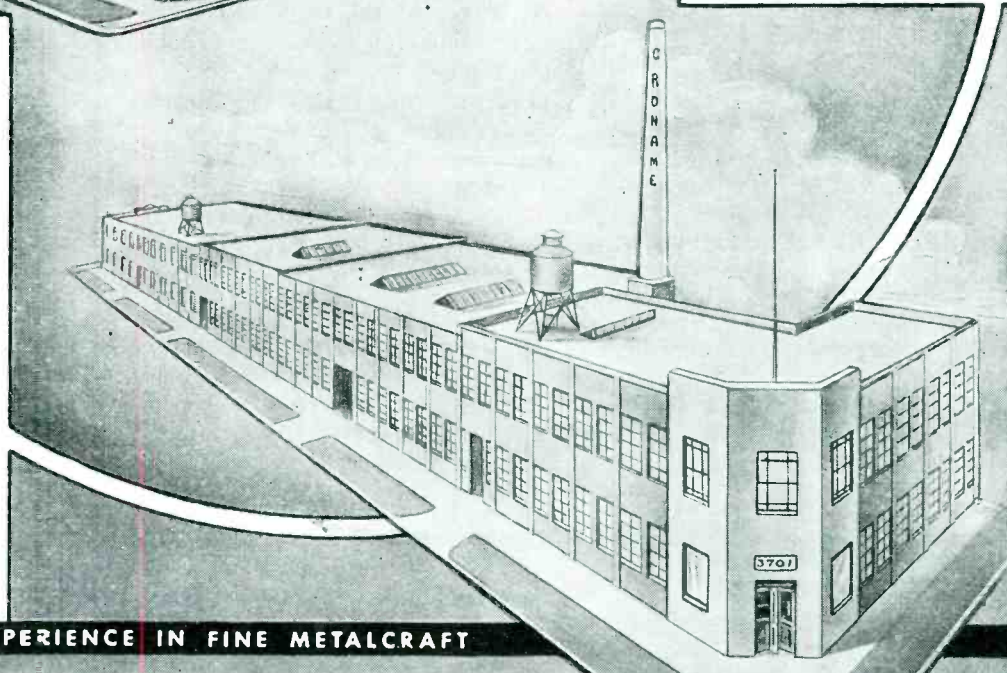

OVER 40 YEARS EXPERIENCE IN FINE METALCRAFT



CRONAME
INCORPORATED

3701 RAVENSWOOD AVENUE
CHICAGO 13, ILLINOIS

With reconversion in full swing

You will want to use and know more about these new sub-miniature vacuum tubes

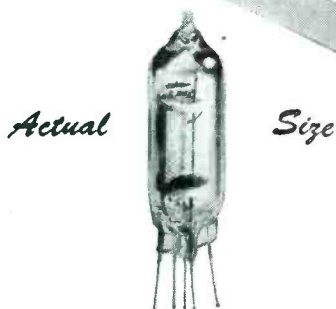

-Series VW- 15 ma., 1.5 volts

Grid current less than 10^{-14} amperes—grid resistance approximately 10^{16} ohms.

Individually checked for uniformity within the range of the best operating characteristics—each tube is built for exacting circuit requirements.

Available as...

Electrometers
Pentodes
Tetrodes
Triodes
Diodes

And now in production—new hi-meg vacuum sealed resistors in a range never adequately covered before—values from 1 megohm to 1,000,000 megohms. Write for literature on tubes and resistors or consult us on your tube problems.

1,000,000 Megohms



Actual size



THE VICTOREEN INSTRUMENT CO.
5806 HOUGH AVENUE
CLEVELAND 3, OHIO

partment since June 1944, is now in the engineering department of Mutual Broadcasting System.

CLURE H. OWEN is allocations engineer with American Broadcasting Co., after serving with the FCC as assistant chief of their broadcast engineering division.

HENRY GROSSMAN, CBS director of technical operations, and JAMES SEWARD, director of operations, are now responsible for technical operations of CBS Television in addition



Henry Grossman

to their regular network broadcast duties. Dr. P. C. Goldmark continues his responsibility for equipment design and installation, engineering standards, and tests.

LOUIS G. PACENT, JR. becomes manager of production services department of Emerson Radio and Phonograph Corp., after a year of service as chief industrial engineer.

T. WANG and T. Y. WANG, representatives of the Chinese Government Communications Commission, interviewed Dr. Ray H. Manson, president of Stromberg-Carlson, during their nationwide tour of key communications centers in search of manufacturing methods and techniques applicable to China's industrial empire.

ERNEST A. MARX, who held the rank of Lieut. Commander in the Navy and the post of Senior Radar Officer of the Third Naval District, joined Allen B. DuMont Laboratories as general manager of their newly formed Television Division.

W. G. H. FINCH, Captain USNR, returns to inactive duty and assumes the presidency of Finch Telecommunications Inc., Passaic,



Attention GI JOE!

Here's Your Opportunity to be First to

Start Your Own RADIO SERVICE SHOP

Complete Starting-in-Business
Package Stocks of

TEST EQUIPMENT
TUBES, PARTS, TOOLS **\$350 up**

Act quickly! Meet the pent up demand for radio service. Turn your special service training into a profitable business of your own. No fuss. No worry. Here's everything you need—\$350 up. Details upon request! Write, wire or phone



TRIPLETT
Volt-Ohm-Milliammeter

A. C.-D. C. Volts
0-10-50-250-1000-5000
at 1000 ohms per volt.
D. C. Milliampere
0-10-100-500
Ohms 0-300-250,000
Case Black molded
3 1/4" x 5 7/8" x 2 1/2"
\$16.00 net

Good News!

ALL
PRIORITIES LIFTED

HALLICRAFTERS SX-28A



\$223

SUPER DEFIANT	SX25	\$94.50
SKY CHAMPION	S20R	60.00
SKYRIDER MARINE	S22R	74.50
SKY RANGER	S39	110.00
ECHOPHONE	ECIA	29.50

ORDERS FILLED AS RECEIVED!!!

MASCO AMPLIFIERS

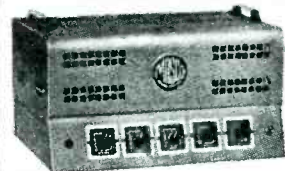

Complete with tubes.

17 Watt	30.30
25 Watt	42.60
35 Watt	54.60
50 Watt	70.50

17 Watt with Phono-top	42.30
25 Watt with Phono-top	52.20
35 Watt with Record-changer	89.10

PHILCO BEAM OF LIGHT

Selenium Cell only, no holder

1.80

20% deposit required on all C.O.D. orders. 2% transportation allowance on orders of \$25.00 or more accompanied by payment in full.

Write for
FREE CATALOG

RADIO SUPPLY & ENGINEERING CO., Inc.

127 SELDEN AVE. DETROIT 1, MICH.

These environment-free products show how *Fedelco-Sealing* can meet Your requirements

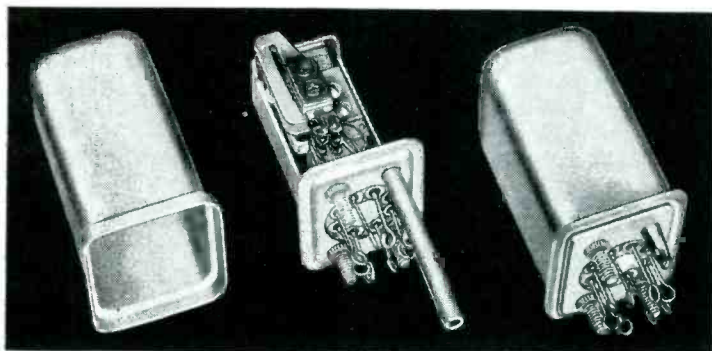

A tiny relay is sealed into this rectangular housing. Photos show: 1, metal housing; 2, relay mounted on heavy bracket and base, with tube for exhausting air; 3, completed enclosure, with three 6-32 mounting screws and terminals for soldering on No. 14 stranded wire. Tube has been sealed off.



Larger relay, with specially designed anchor plate mounting to withstand shock and vibration up to 20Gs. Relay is bolted to heavy bracket and anchor plate (top left) and base plate. Completed enclosure (right) shows beads rolled into top and bottom of housing to grip both plates, and square base for bolting to frame. Lead wires have been soldered to octal plug.

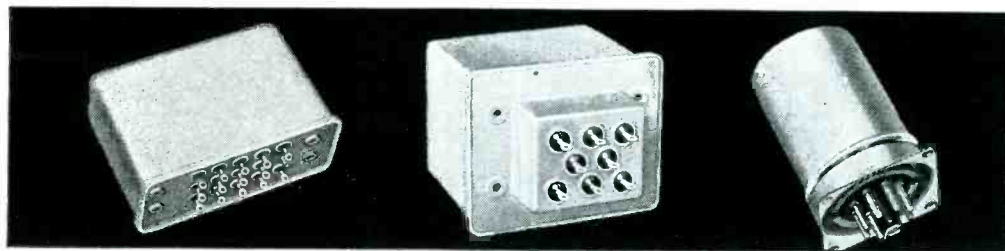

Three other specially designed enclosures. 1. Oblong case for a large relay, with leads for soldering connection. Mounting sockets in base for 8-32 machine screws. 2. Rectangular case for aviation type transformer, specially designed to fit same mounting as transformer had before moisture trouble made Fedelco-Sealing necessary. 3. Small relay, arranged for plug-in.

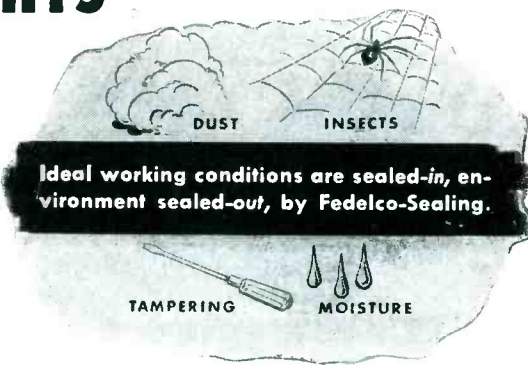

Fedelco-Sealing insures the long life and unfailing performance built into your product, by sealing it into an air tight metal housing that keeps out bugs, dust, fungus, moisture, and tampering.

Designed for Your Requirements

These enclosures are designed and engineered to fit your product and your specific requirements. Cases can be of any required shape, with various provisions for mounting. Terminals can be wired to an octal plug, or to solder terminals. Interior mounting and brackets are specially designed. Cases are exhausted and filled with nitrogen or other gas. Enclosures can be designed to withstand shock and vibration of any degree specified.

We Fedelco-Seal your product, or show you how to do it

Ship your product to us, and we will design the enclosures, and complete the Fedelco-Sealing job. Or, if your quantities justify, you can do your own Fedelco-Sealing, with equipment we will design for you.

Get Details Now

Send us a sample, describe your requirements and problem, and we will give you complete and specific information. Write or phone us today.



FEDERAL ELECTRIC COMPANY, INC.

8700 South State Street, Chicago 19, Illinois • Phone VINcennes 5300

ELECTRICITY

FOR ANY JOB
—ANYWHERE

★ **ONAN ELECTRIC GENERATING PLANTS** supply reliable, economical electric service for electronics applications as well as for scores of general uses.

Driven by Onan-built, 4-cycle gasoline engines, these power units are of single-unit, compact design and sturdy construction. Suitable for mobile, stationary or emergency service.

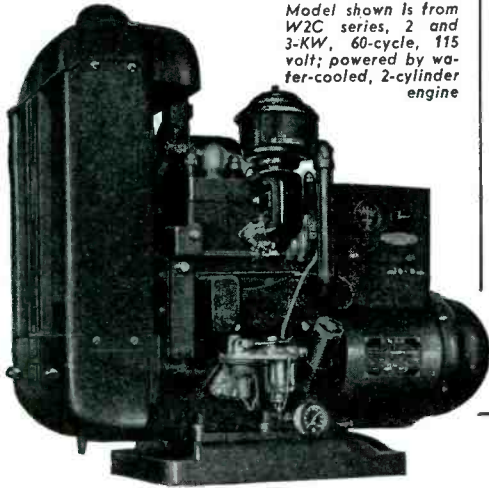

Model shown is from W2C series, 2 and 3-KW, 60-cycle, 115 volt; powered by water-cooled, 2-cylinder engine



"Models range from 350 to 35,000 watts. A.C. types from 115 to 660 volts: 50, 60, 180 cycles, single or three-phase; 400, 500, and 800 cycle, single phase; also special frequencies.

D. C. types range from 6 to 4000 volts.

Dual voltage types available.

Write for engineering assistance or detailed literature".

D. W. ONAN & SONS— 3271 Royalston Ave. Minneapolis 5, Minn.



MOLDITE IRON CORES

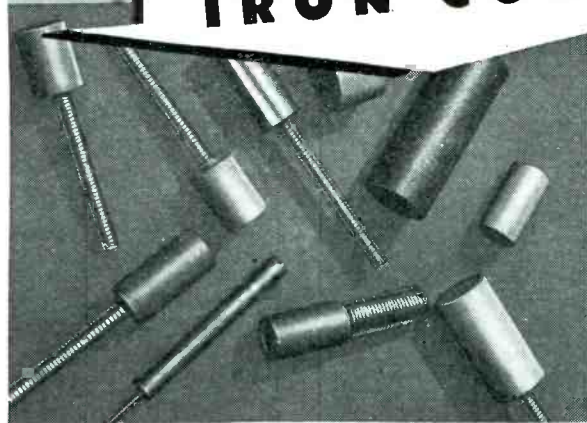

HIGHER Q:

New formulae make possible higher Q at all frequencies.

PERMEABILITY:

Accurate powder control results in uniform density and higher permeability.

FREQUENCIES:

Q and permeability exactly as specified for ultra high, high, medium and low frequencies.

TOLERANCES:

Modern facilities permit rigid adherence to the most critical mechanical and electrical specifications.

TOOLING:

Tools, dies and fixtures designed and built on the premises for unimpeded, uniform production.

PRODUCTION:

Modern, automatic production assures high speed economy; guarantees "on time" delivery at all times.

MOLDITE CAPABILITIES — engineering and production — are integrated to meet your iron core requirements with speed, precision and economy. Any size run and the most critical specifications can be efficiently handled with product uniformity assured throughout. Further, the capable MOLDITE engineering staff offers experienced guidance in meeting present and post-war iron core requirements for any size coil or transformer.

Write for Moldite Engineering Bulletin 100.

NATIONAL MOLDITE COMPANY
25 MONTGOMERY STREET, HILLSIDE 5, NEW JERSEY



N. J. He also plans to resume construction on f-m station WGHF, New York.

AWARDS

Workers of the following concerns in the electronics field have been awarded Army-Navy burgees for excellence in production:

Eastern Amplifier Corp.
New York, N. Y.

National Union Radio Corp.
Robesonia, Pa.

The Workshop Associates
Newton Highlands, Mass.

The Bureau of Ordnance E has been awarded to the following firm for cooperation on the VT-fuze project:
International Resistance Co.
Philadelphia, Pa.

Surplus Parts and Equipment Agents

THREE LISTS handling government surplus electronic parts and equipment of manufacturer-agents have been released by RFC (Reconstruction Finance Corp.). They cover agents for component parts, agents for complete gear of their own make, and agents who will dispose of products of other concerns as well.

COMPONENT PARTS

Company	Address	Component
Advance Transformer	1161 W. Madison St. Chicago, Ill.	Transformers
Air Design & Fabrication, Inc.	241 Fairfield Ave. Upper Darby, Pa.	Transformers
American Phenolic Corp.	1830 So. 54th Ave. Chicago 50, Ill.	
American Transformer Corp.	178 Emmet St. Newark, N. J.	Transformers
Amperex Electronic Corp.	79 Washington St. Brooklyn, N. Y.	Power Tubes
Anco Products Co.	932 Market St. Paterson, N. J.	Transformers
Arco Transformer & Elec. Div. National Mill Supply Co.	207 E. Columbia St. Fort Wayne, Ind.	Transformers
Barker and William-son Co.	235 Fairfield Ave. Upper Darby, Pa.	Capacitors, Coils
Best Mfg. Co.	1200 Grove St. Irvington, N. J.	Transformers, Coils, Speakers, Microphones, Head Sets
James G. Biddle Co.	1211 Arch St. Philadelphia 7, Pa.	Vibrating Reed Tachometers, Vibrating Reed Frequency Meters
Bogue Electric Co.	37 Kentucky Ave. Paterson, N. J.	Electronic Components and Equipments
Burlington Instrument Co.	106 N. 4th St. Burlington, Iowa	Panel Instruments, Meters
Capacitron Co.	849 No. Kedzie Ave. Chicago 51, Ill.	Capacitors

RHEOSTATS

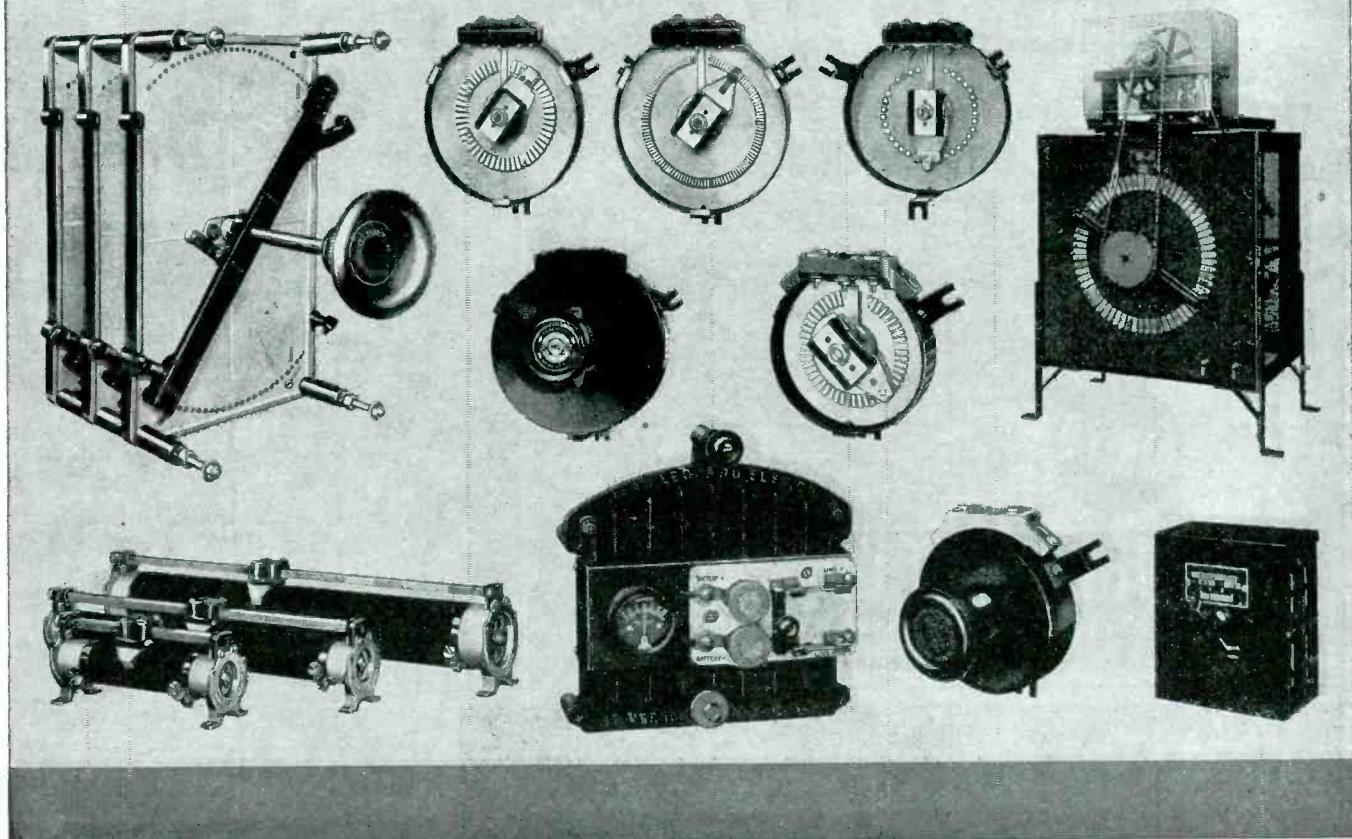

The Ward Leonard line of rheostats includes the widest range of sizes, tapers and current ratings from the tiny types for radio to huge multiple assemblies for the heaviest industrial use. Smooth operation, durable contacts and extreme dependability characterize all Ward Leonard Rheostats, Resistors and Relays. Write for bulletins of interest to you.

WARD LEONARD

RELAYS • RESISTORS • RHEOSTATS



Electric control (WL) devices since 1892.

WARD LEONARD ELECTRIC COMPANY • 32 SOUTH ST. • MOUNT VERNON, N. Y.

**PERFECT YOUR
POST-WAR
PRODUCTS
WITH DIALCO**

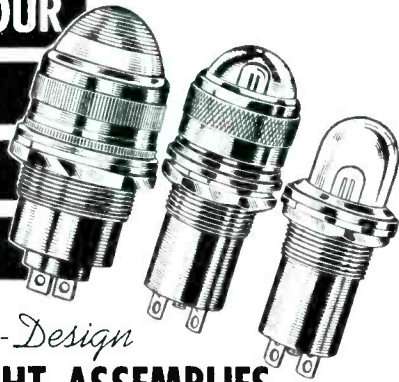

Functional-Design
PILOT LIGHT ASSEMBLIES

HOUSING NEON OR MAZDA LAMPS

GREATER emphasis on functional design is the trend in post-war engineering of Electrical-Electronic Products. Mindful of this fact, Dialco has produced a line of Pilot Lights calculated to meet readily all post-war requirements. Comprising Warning-and-Signal Pilot Lights, Panel Lights, Jewel Assemblies, and Socket Assemblies, the Dialco line offers unlimited variations in functional design, size, shape, electrical characteristics, color, finish, etc. Special emphasis on applications of NEON or MAZDA Lamps.



Let our Engineering Dept. help you select the Pilot Light best suited to the functional design of your post-war product.

PLUS LAMPS: To help speed production, we offer Pilot Lights completely assembled with the required General Electric or Westinghouse Lamps.

WRITE FOR NEW ILLUSTRATED BROCHURE

DIAL LIGHT CO. of America, Inc.

900 BROADWAY • NEW YORK 3, N. Y.

Telephone: ALgonquin 4-5180-1-2-3

Company	Address	Component
Carborundum Co. (Glober Div.)	Hyde Park Blvd. Niagara Falls, N. Y.	Resistors
Allen D. Cardwell Mfg. Co.	81 Prospect St. Brooklyn 1, N. Y.	Capacitors
Chatham Electronics	475 Washington St. Newark, N. J.	Radio Tubes
Chicago Condenser Corp.	3917 Fullerton Ave. Chicago, Ill.	Capacitors
Chicago Industrial Instrument Co.	219 W. Chicago Ave. Chicago, Ill.	Electronic and Associated Equip.
Chicago Transformer Div. Essex Wire Corp.	4216 W. Irving Park Rd. Chicago, Ill.	Transformers, Resistors
Cinch Mfg. Corp.	2335 West Van Buren St. Chicago 12, Ill.	Electronic Component Parts
C. P. Clare & Co.	4719 Sunnyside Ave. Chicago 30, Ill.	Switches, Relays
Cole Instrument Co. (Electric Products Service)	1320 So. Grand Ave. Los Angeles, Cal.	Meters, Test Equipment
Consolidated Radio Products Co.	350 W. Erie St. Chicago 10, Ill.	Head Sets, Transformers, Speakers
Continental Electric Co.	715 Hamilton St. Geneva, Ill.	
Control Corp.	600 Stinson Blvd. Minneapolis, Minn.	Coils, Transformers, Chokes
Cords Ltd., Inc.	126 Orchard St. Newark, N. J.	Cord Sets, Electrical Components
Cosmic Radio Corp.	699 E. 135th St. New York 54, N. Y.	Capacitors
Daven Company	191 Central Ave. Newark, N. J.	Resistors
Dean W. Davis & Co., Inc.	Kentland, Indiana	Transformers, Coils, Solenoids
De Jur Amsco Corp.	Northern Blvd. at 45 St. Long Island City 1, N. Y.	Electric Meters, Potentiometers
Tobe Deutschmann Corp.	863 Washington St. Canton, Mass.	Capacitors, Filters, Noise Meters
Dumont Electric Company	34 Hubert St. New York, N. Y.	Capacitors
Thos. A. Edison, Inc.	51 Lakeside Ave. West Orange, N. J.	Panel Instruments
Eitel-McCullough, Inc.	525 West 13th St. Salt Lake City, Utah	Tubes, Capacitors, Relays
Electrical Reactance Corp.	49 Elm St. Franklinville, N. Y.	Resistors, Capacitors, Choke Assemblies
Electrical Utilities Co.	La Salle, Ill.	Paper Capacitors
Electrical Windings, Inc.	2015 No. Kolmar Ave. Chicago, Ill.	Transformers, Coils
Electricoil Transformer Co.	421 Canal St. New York, N. Y.	Transformers, Reactors, Chokes, Coils, Rectifiers
Electro-Motive Mfg. Co.	So. Park & John Sts. Willimantic, Conn.	Capacitors
Electronic Development Co.	1336 N. Saddle Creek Rd. Omaha 3, Nebr.	Panel Instruments, Test Equipment, Noise Filters
Electronic Engineering Co.	733 W. Ohio St. Chicago, Ill.	Transformers, Chokes, Wave Filters
Electronic Enterprises, Inc.	67 Seventh Ave. Newark 4, N. J.	Transmitting Tubes
Electronic Transformer Co.	205 W. 25 St. New York, N. Y.	Transformers
Electro-Voice Corp.	1239 So. Bend Ave. South Bend, Ind.	Microphones

QUALITY CONTROL

of **MICA**



FOR EVERY RADIO ELECTRICAL AND ELECTRONIC USE

FORD RADIO & MICA CORP.
Joseph J. Long, President

538 63rd St.,
Brooklyn 20, N. Y.
Telephone:
Windsor 9-8300

We have consistently maintained Quality Control over production of fabricated mica parts, including those for the exacting requirements of radio and electronic fields. Close tolerances on dimensional measurements are attained by our use of the most advanced equipment in optical magnification and contour measurement. The raw mica is continuously inspected to assure high dielectric value.

Our entire personnel is trained to be quality-minded, which means ingrained accuracy and integrity. By use of our Incentive System, employees have much to gain by conscientious work. Our thorough Training Program makes it easy for employees to adhere closely to the high standards we demand. We invite discussion of your particular needs.

Established
1917

Two big NEWARK stores well stocked to serve your needs and staffed by people who know and can help solve your problems.

THIS MONTH'S FEATURES



HALLICRAFTERS

SX-28A	Super Skyrider with crystal, less speaker	\$223.00
S-20R	Sky Champion with built-in speaker	60.00
S-22R	Skyrider Marine with built-in speaker	74.50
SX-25	Super Defiant with crystal, less speaker	94.50
S-39	Sky Ranger portable, AC/DC and battery	110.00
SX-36	FM/AM receiver	415.00
S-37	V.H.F. FM/AM receiver	591.75
	10" PM speaker in cabinet for use with SX-25, SX-28A	15.00

HAMMARLUND

HQ-129X (with tubes)	\$129.00
ASPC-210X	318.00
ASP-2105X	318.00

Available for rack mounting at same prices

NATIONAL

NC-2-40C and speaker	\$240.00
----------------------	----------

RME

RME-45 and speaker	\$166.00
--------------------	----------



THORDARSON TRANSFORMER

(POWER TRANSFORMERS AND CHOKES)

T-45556 or T-92R21 leads out of side, 778 V. C. T. at 200 MA. 115 V. 60 Cycle 6.3 V. C.T. at 5A. 5 V. at 30 amp. 9 lbs.	\$5.29
T-13C30 8H. 150 MA. 200 ohm 1600 V. Insulation 2 1/4 lbs.	1.41
T-4557 or T-74C29 leads out of side. 1 5/8. 150 MA. 200 ohm 2000 V. Insulation 5 1/4 lbs.	2.82

WESTERN ELECTRIC MICRO AMMETERS



Bakelite case fits 3/4" hole. Radium dial 150-0-150. Can be used with 0-200 micro and amp scale listed below. Excellent as a 5,000 ohm-per-volt meter or null, sound level and galvanometer indicator. Instructions included. No priority required. \$7.50
0-200 paper scale for above. .15

THE FAMOUS NEWARK BARGAIN OIL-FILLED, OIL-IMPREGNATED

FILTER CONDENSERS

FULLY GUARANTEED AT RATED VOLTAGES

Capacity	Working Voltage	Height	Width	Depth	Wt.	Price
1 mfd.	1500 V. D.C.	2 3/16	1 3/4	1"	4 oz.	\$.79
17 1/2 mfd.	1500 V. D.C.	3 3/8	4 7/8	3 3/8	3 lbs.	2.75
11 1/2 mfd.	1500 V. D.C.	5	3 3/4	1 1/2	1 lb. 10 oz.	2.00
5 mfd.	1500 V. D.C.	4	2 3/8	1 1/4	14 oz.	1.65
5 mfd.	2000 V. D.C.	4	3 3/4	1 1/4	1 lb. 4 oz.	2.15
8 mfd.	2000 V. D.C.	4 1/2	3 3/4	2 1/2	2 1/2 lbs.	2.75
.25 mfd.	2000 V. D.C.	3 3/4	1 3/4	1	6 oz.	.69
Special Porcelain Insulators						
10 mfd.	3000 V. D.C.	4 7/8	3 3/4	3 3/4	3 lbs. 8 oz.*	4.75
15 mfd.	3000 V. D.C.	4 3/4	4 3/8	3 7/8	5 lbs.	5.25
6 mfd.	3000 V. D.C.	6 3/8	6 1/2	3	5 lbs. 6 oz.	3.25
with mounting feet, width includes mounting feet						
8 mfd.	3000 V. D.C.	7 3/8	6 1/2	3 3/8	7 lbs. 4 oz.	3.95
2 mfd. & 4 mfd.	600 V. metal con	4 7/8	2 1/2	1 1/4	14 oz.	.80

McELROY KEY

The DeLuxe — Model CP 810 \$9.75

GENERAL ELECTRIC METERS

0-500 D.C. MA. 2" round Bakelite case.. \$3.50
0-8 RF ammeter, 2" round Bakelite case.. \$4.00

ABBOTT TR-4

Compact, efficient 2 1/2 meter transmitter-receiver \$39.00

GET YOUR NAME ON YOUR MAILING LIST

Be first to get announcements of merchandise available, special bargains, etc., etc. Send name and address on post card. State whether amateur, engineer, school, industrial or service man. Address orders and inquiries to Dept. E, at NEWARK store nearest you.



CHICAGO
Newark **ELECTRIC** Company
NEW YORK

115-117 W. 45th St.
NEW YORK 19
Bryant 9-4735
(Adolph Gross)

"Dependable Service
is the Foundation
of our Business"

323 W. Madison St.
CHICAGO 6
DEArborn 0083
(Sam Poncher)

ALL PRICES SUBJECT TO CHANGE WITHOUT NOTICE



ORIGINALITY WITH ROOTS

Clever in devising forms, assembly and effects in all types of plastics for products, displays and containers. Cleverness that is deep-rooted in long experience, in exceptional facilities and in competent manpower. The kind of cleverness which combines the ability to create with the ability to produce economically, efficiently and in quantity. That is the service we have to offer — originality deep-rooted in practicability.

Northern

INDUSTRIAL CHEMICAL CO.

7-11 ELKINS STREET, SO. BOSTON 27, MASS.

WHAT DO YOU NEED IN A FAN FOR ELECTRONIC APPLICATIONS?

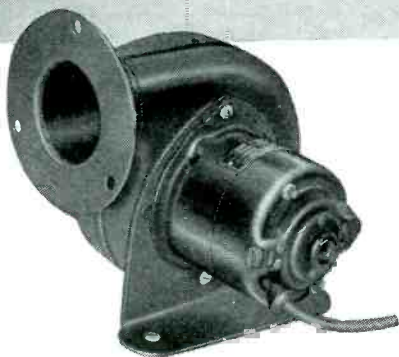

Model 6 S—6 1/2" high



10" Ilgette Model

• Standard types of fans adapted to your needs . . . or special fans engineered to order . . . BOTH are available from ILG! With the thousands of ILG products made for the U. S. Signal Corps, Maritime Commission and Navy

it is possible that we are tooled up for the size, capacity or mounting arrangement you require. Write giving details of your problem or phone nearby Branch Office (consult classified directory) for competent engineering help.



ILG ELECTRIC VENTILATING CO., CHICAGO 41, ILL.
2882 No. Crawford Ave. • Offices in 40 Principal Cities

VITALIZED VENTILATION
AND AIR CONDITIONING



Model 201

The Time-Tested, Reliable **VIBROTEST** Insulation Resistance Tester

Since 1938 VIBROTESTS have proven the soundness of this modern method of testing insulation resistance. Superbly engineered, ruggedly built, this pioneer instrument in CRANKLESS INSULATION TESTING offers the utmost in usefulness and value.

VIBROTEST Is Thoroughly Modern

No hand cranking, no leveling, no shocks to the operators. Wide range 0-200 megohms covering values usually encountered in general testing are instantly available from a self-contained power source providing a constant potential of 500 Volts D.C.

Available in this one compact instrument are a convenient Ohmmeter scale as well as A.C. and D.C. voltage ranges up to and including 600 volts full scale. Other models with 1,000 volts D.C. potential also available.

Many Other VIBROTESTS

are designed for specific uses involving unusual ranges or operating conditions. WRITE for full information at your earliest opportunity.

Engineering Service Representatives in
All Principal Cities



223 So. Green St.
Chicago 7, Ill.

December 1945 — ELECTRONICS

Company	Address	Component
Erie Resistor Corp.	644 W. 12th St. Erie, Pa.	Resistors, Capacitors
John E. Fast & Co.	3123 No. Pulaski Rd. Chicago 41, Ill.	Capacitors, Choke Coils
Federal Telephone & Radio Corp.	591 Broad St. Newark, N. J.	Radio Component Parts
General Electric Co.	Bldg. 267, River Rd. Schenectady, N.Y.	Electron Tubes
General Electronics, Inc.	1819 Broadway New York 23, N. Y.	Power Tubes
Glenn-Roberts Co.	3100 E. 10 St. Oakland 1, Calif.	Transformers, Capacitors, Chokes
Gruen Watch Co.	Cincinnati, Ohio	Panel Indicating Instruments
Guardian Electric Mfg. Co.	1400 Washington Blvd. Chicago 7, Ill.	Relays, Solenoids
Hammarlund Mfg. Co.	460 W. 34 St. New York 1, N.Y.	Resistors, Capacitors
Hercules Electric & Mfg. Co., Inc.	2500 Atlantic Ave. Brooklyn 7, N. Y.	Transformers, Reactors, Choke Coils, Inductors
H.R.S. Radio Products	5707 W. Lake St. Chicago, Ill.	Capacitors
Hudson American Corp.	25 W. 43 St. New York 18, N. Y.	Transformers, Electronic Components
Hytron Radio & Electronics Corp.	76 Lafayette St. Salem, Mass.	Receiving and Transmitting Tubes
Illinois Condenser Co.	1160 No. Howe St. Chicago, Ill.	Capacitors
Industrial & Commercial Electronics	P.O. Box 296, Belmont, Calif.	Transmitting Tubes, Vacuum Condensers, Components
Industrial Condenser Corp.	3243—65 No. Calif. Ave. Chicago 18, Ill.	Capacitors
Industrial Transformer Corp.	2340 Belmont Ave. New York 58, N. Y.	Transformers
Insuline Corp. of America Inc.	3602 35 Ave. Long Island City, N. Y.	Various Electronic Products
International Resistance Co.	401 No. Broad St. Philadelphia, Pa.	Resistors
Jensen Radio Mfg. Co.	6601 So. Laramie Ave. Chicago 38, Ill.	Speakers, Transformers
E. F. Johnson Co.	206 Second Ave., S. W. Waseca, Minn.	Capacitors, Hardware, Inductors
Ken-Rad Div. General Electric Co.	3rd & St. Elizabeth Sts. Owensboro, Kentucky	Receiving and Transmitting Tubes
Lewis Electronics	16 Lyndon St. Los Gatos, Calif.	Transmitting Tubes
Light Electric Company	214 Lackawanna Ave. Newark 4, N. J.	Transformers
Madison Electrical Products Corp.	78 Main St. Madison, N. J.	Resistor
Maguire Industries	500 Fifth Ave. New York, N. Y.	Transformers
Micamold Radio Corp.	1087 Flushing Ave. Brooklyn, N. Y.	Capacitors, Resistors
August C. Miller Co.	9226 Hudson Blvd. N. Bergen, N. J.	Crystal Assemblies
Milwaukee Resistor Company	130-A West Pittsburgh Milwaukee, Wisc.	Resistors
Muter Company	1255 So. Michigan Ave. Chicago, Ill.	Resistors, Coils, Capacitors, Switches
National Scientific Products Co.	5013-25 No. Kedzie Ave. Chicago 25, Ill.	Crystal Oscillators, Headsets, Portable Electric Megaphones



An Announcement To Those Who Require The Best

THIS advertisement is addressed to the manufacturers of electronic equipment whose product demands the best in component parts—who will want the best in transformers, if “the best” is offered at a price that will fit the cost specifications of their finished product. By adapting to peace-time use the major features of the Hermetically-Sealed transformer construction that won war-time leadership, Chicago Transformer is prepared to provide the best in transformers to those who require them. Fully developed basic mounting parts, when utilized on a mass production basis, will provide the element of economy in manufacture.

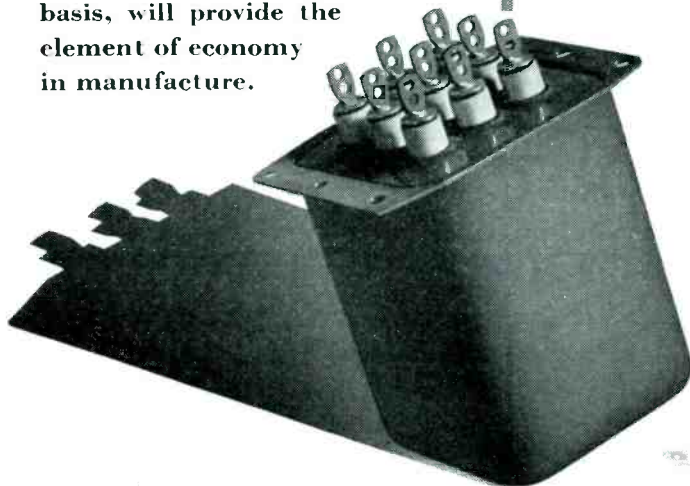

CHICAGO TRANSFORMER

DIVISION OF ESSEX WIRE CORPORATION

3501 WEST ADDISON STREET

CHICAGO, 18



TRADE MARK REG.



NEW SOLDERING GUN

THE SPEED IRON*



Patent Applied For

100 Watts 115 Volts 60 Cycles

Soldering Heat in 5 Seconds

Wherever you have a soldered joint in radio, electrical or electronic repair and service work, the Speed Iron will do the job faster and better.

The transformer principle gives high heat—in 5 seconds—after you press the trigger switch. Convenient to hold with a pistol grip handle, the compact dimensions of this new soldering tool permit you to get close to the

*T.M. Reg. U. S. Pat. Off.

joint. The copper loop soldering tip permits working in tight spots. The heat is produced by the high current flowing through the soldering tip—permitting direct and fast transfer to the soldered connection.

If you want to save time on soldering jobs with a tool that is ready to use in 5 seconds, get a Speed Iron today. See your radio parts distributor or write direct.

WELLER MFG. CO.

DEPT. E-1 • EASTON, PA.

ALDEN RADIO COMPONENTS

CATHODE RAY SOCKETS



211-214 Series

801-S PLUGS

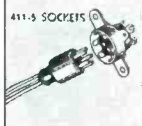

MINIATURE CONNECTORS

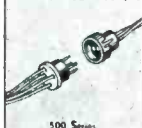

121-S PLUGS



AC OUTLET



AC LINE CORDS

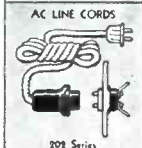

FUSEHOLDER



TUBE CAP CONNECTORS



TUNING EYES



DETACHABLE TERMINAL CONNECTORS

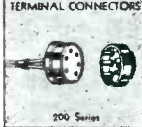

211 and 214 SERIES CATHODE RAY TUBE CONNECTOR WITH LEADS

Any requirements in a cathode ray tube connector complete with the proper leads attached are specially engineered as a complete assembly to insure high safety factors in all kinds of service. For octal, magnum, diaphragm bases and any new cathode ray tube. Have super-long leakage paths, rounded, "coronaless" clips and individual pocket type insulation and strain relief for each lead. Having the complete assembly gives you the best obtainable connector plus the economies of standardization.

801-S SHIELDED PLUGS AND 411-S METAL SOCKETS

Shielded plug and socket for automobile sets or for any other equipment where leads must be shielded and shield grounded to chassis. One to five circuits. Individual insulation for each lead prevents shorting by vibration. Shield is easy to put on and solder to plug. Supplied with or without shielded cable.

MINIATURE CABLE CONNECTORS 500 SERIES

One to four circuit cable connectors—famous for connecting AC motors in combination sets and all kinds of "through-panel" work. Overall diameter only $\frac{3}{4}$ ". Eliminates ponderous "ball and chain" devices. Save labor costs by having our special wire equipment put on leads to your particular needs. Each lead has individual "pocketed" insulation and strain relief. Underwriters approved.

121-S MINIATURE PLUGS AND 441-S SOCKETS

Compact plug and metal seal socket of 1 to 5 circuits. Use when you want connector to come directly out of chassis. Plug supplied with leads to your specifications. Socket has individual "pocketed" insulation on each lead and clip.

AC OUTLET 402AC

Smallest possible outlet that can be eyeletted or rivetted to chassis like other components. Solder tabs designed for easy soldering.

AC LINE CORDS 202 SERIES

Here is a detachable AC line and with socket, that is neat and compact. Socket eyelets or rivets in place like other components. Underwriters approved. Special cords and plugs to your specifications.

FUSEHOLDER 440FH

Here is a fuseholder that rivets or eyelets in place like the other components in your set. Cannot twist or turn, does not require special wrenches for assembly. Has spring to eject fuse if it breaks. Spring makes contact at base of fuse and prevents rattle. Top contact slotted for easy removal of fuse ferrule when glass breaks. Tabs are of special design for ease in attaching primary leads of ample size for any current carrying requirements.

90 SERIES TUBE CAP CONNECTORS WITH LEADS

Any requirement in tube cap connectors supplied with leads of proper voltage handling characteristics. Many made special, hundreds of moldings, stampings and wire to draw on.

206-B TUNING EYES WITH LEADS

Socket supplied with tailor-made leads attached. With or without escutcheon and bracket. Individual insulation and strain relief for each lead.

200 SERIES DETACHABLE TERMINAL CONNECTORS

Two to eight circuit detachable connector. Replaces terminal strips. Supplied with leads attached. Each lead has individual insulation and strain relief.

WIRE AND CABLE

Any kind of wire or cable laced, braided, woven or assembled with any of our components or those of other make. Many types of wire in stock and in process.

NEW ITEMS

When you want to get into production fast, Alden is a specialist in bringing through special electrical assemblies, new items in small or large quantities. Samples made promptly.

REGULATED POWER SUPPLY

250-450 VOLTS

Wide fields of application have been opened up both in research and industry for this unit. A-C ripple is negligible and extreme care has been taken to eliminate high-frequency noise. Regulated power supply units are invaluable for such applications as amplifiers, television pulse generators, constant frequency oscillators, and measuring equipment.

Other G-E regulated power-supplies are available in the following ranges: 180-300 volts 160-1500 volts Dual Regulated

Write today: Electronics Department, Specialty Division, General Electric, Syracuse, N. Y.

GENERAL ELECTRIC

164-D1

Electronic Measuring Instruments

PS-1

Electrical Recording Instruments

Special instruments to record electrical impulses as they occur with all the minute variations of intensity and duration, free from the lag and inertia of present systems. "Electrographic" recorders we can supply, include a complete line of facsimile recorders, specially engineered recorders for high speed signal analysis, slow speed recorders for day by day events, multi-trace recorders for simultaneous recording of any phenomena that can be reduced to electrical impulses.

ALDEN PRODUCTS COMPANY
BROCKTON 64 MASS.

Company	Address	Component
National Union Radio Corp.	15 Washington St. Newark, N. J.	Receiving and Transmitting Tubes
Newark Transformer Co.	17 Frelinghuysen Ave. Newark, N. J.	Transformers, Reactors
Newton Co.	244 W. 23 St. New York 11, N. Y.	Transformers
New York Transformer Co.	26 Waverly Pl. New York 3, N. Y.	Transformers
North American Philips Co., Inc.	100 E. 42nd St. New York, N. Y.	Electron Tubes
Ohio Carbon Co.	12508 Berea Rd. Cleveland, Ohio	Resistors
Oxford-Tartak Radio Corp.	3911 S. Michigan Ave. Chicago, Ill.	Speakers
Permoflux Corp.	4900 West Grand Ave. Chicago 39, Ill.	Headsets, Speakers
Precision Resistor Co.	334 Badger Ave. Newark 8, N. J.	Resistors
Premier Electronics Products, Inc.	4849 North Western Ave. Chicago, Ill.	Transformers
Presto Electric Co.	4511 New York Ave. Union City, N. J.	Resistors
Quam-Nichols Co.	33 Pl. & Cottage Grove Ave. Chicago 16, Ill.	Speakers
Radio Corporation of America RCA Victor Div.	Camden New Jersey	Electron Tubes
Radio Development & Research Corp.	233 W. 53 St. New York, N. Y.	Electronic Equipment
Radionic Controls	3758 W. Belmont Ave. Chicago 18, Ill.	Relays, Transformers
Raytheon Mfg. Co.	55 Chapel St. Newton 55, Mass.	Receiving and Transmitting Tubes, Transformers
R-B-M Mfg. Co. Div. Essex Wure Corp.	Logansport Indiana	Relays
Red Arrow Electric Corp.	132 Lincoln Pl. Irvington, N. J.	Transformers
Reimers Elec. Appl. Co., Inc.	596 56 St. West New York, N. J.	Wire Wound Resistors
Sangamo Electric Co.	11th & Converse St. Springfield, Ill.	Capacitors
Shallcross Mfg. Co.	Jackson & Pusey Ave. Collingdale, Pa.	Resistors
F. W. Sickles Co.	165 Front St. Chicopee, Mass.	Capacitors, Coils, Chokes, Subassemblies, Potentiometers
Simpson Electric Co.	5218 West Kinzie St. Chicago, Ill.	Panel Instruments, Test Equipment
Slater Mfg. Co.	728 Atlantic Ave. Brooklyn, N. Y.	Power Tubes
Sola Electric Co.	2525 Clybourn St. Chicago, Ill.	Transformers
Solar Mfg. Corp.	285 Madison Ave. New York 17, N. Y.	Capacitors
Sonotone Corporation	Elmsford, New York	Tubes, Headsets, Transformers
Speaker Corp. of Chicago	230 W. Superior St. Chicago, Ill.	Speakers
Sperti, Inc.	Beech & Kenilworth Ave. Cincinnati, Ohio	Electron Tubes
Standard Arcturus Corp.	30-34 Court St. Newark 2, N. J.	Receiving Tubes
Standard Coil Products Co.	2329 No. Pulaski Rd. Chicago, Ill.	Radio Coils, Crystals

RADIO PARTS

ELECTRONIC EQUIPMENT

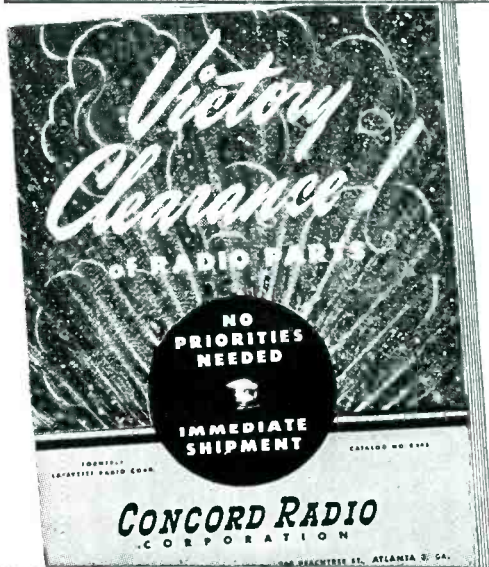

Mail Coupon NOW for CONCORD Victory Clearance Flyer—FREE!

Ready now! 32 Bargain-packed pages listing thousands of standard-make, top-quality radio parts and electronic supplies — now available without priority at low VICTORY CLEARANCE prices. The values listed at the left are typical of the important savings offered in Meters, Condensers, Transformers, Resistors, Controls, Switches, Relays, Test Equipment, Generators, Microphones, Tools, and hundreds of Repair, Replacement, and Accessory Parts. On special requirements, Concord experts are ready to help you in expediting and speeding action on essential needs.

Order Today for Shipment Tomorrow from CHICAGO or ATLANTA

Huge stocks in two convenient warehouses—one in CHICAGO and one in ATLANTA—are ready to supply you quickly with needed parts of dependable, nationally-known quality—and at VICTORY CLEARANCE prices that mean real savings. Mail the coupon below NOW for your FREE copy of CONCORD'S VICTORY CLEARANCE Flyer.

Check These Typical CONCORD VALUES!



D. C. Milliammeters

2 1/4" flange mtg. type. Metal case dull black finish. G. E. 0-200 M. A. C10650 Specially Priced \$4.95



Plate Power Transformer

Pri. tapped at 115, 117 and 120 V.A.C. Sec. output 850 V. at 200 ma. c. t. 4 1/4" L x 3 3/4" W x 3 3/8" H. 5B5035 Your cost \$4.29



Dry Electrolytic Condenser

Hermetically sealed. Size 1 1/2" x 3". Can negative. Cap.: 40 mfd. at 475 volts; 15 mfd at 350 volts; 15 mfd at 150 volts; 20 mfd at 25 volts. 5B-3161 Each 59c

Output Transformer

Hermetically sealed. Six studs. 1, 2, and 3 are pri. 4, 5, and 6 the sec. Pri. ind. at 5 V. 1000 ev. .20 H. Ratio sec. to pri. 3.02:1. size: 3 1/4" x 2 1/4" 5B-5045 Your cost \$1.95



Mobile High Voltage Power Unit

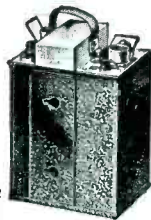

Input 12 V at 10 a m p s. Output consists of two voltage ranges: (1) 275 at 110 ma. (2) 500 at 50 ma. 5B9518 Your cost \$39.50

CONCORD RADIO CORP.

LAFAYETTE RADIO CORPORATION

CHICAGO 7, ILL.

ATLANTA 3, GA.

901 W. Jackson Blvd. ★ ★

265 Peachtree Street



300 Watt Rheostat

Wire wound. Vitreous enameled. Cast aluminum base. 6" dia. 2 1/2" deep. 1400 ohms. 5B9517 Your cost \$3.95

CONCORD RADIO CORPORATION
901 W. Jackson Blvd.
Dept. G-125, Chicago 7, Ill.
Please RUSH FREE copy of
CONCORD'S new 32 page
VICTORY CLEARANCE Flyer.



Name

Address

City..... State.....

W



Let us tell you about our unusual service to manufacturers requiring small sheet metal parts

SEND FOR NEW CATALOG

WATERBURY METAL PARTS

*Eyelets
Ferrules
Terminals*

WATERBURY COMPANIES, INC.
FORMERLY WATERBURY BUTTON CO., EST. 1812
McGRAW AVE., WATERBURY, CONN.

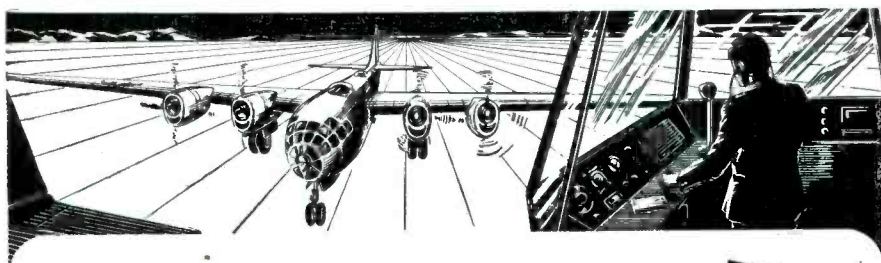

An Invitation to All Electrical Designers to **TRY SILVER GRAPHALLOY**

FOR BRUSHES

High current density, low contact drop, low electrical noise, and self-lubrication are characteristics of this silver-impregnated molded graphite that may be the answer to your electrical brush problems

SAMPLES of Silver Graphalloy will be gladly furnished for test on your applications. Silver Graphalloy is usually silver plated to permit easy soldering to leaf springs or holders. Why not WRITE NOW for your test samples?

FOR CONTACTS

Low contact resistance and non-welding when breaking surge currents are inherent properties of this unique combination of conductive silver and self-lubricating graphite

GRAPHITE METALLIZING CORPORATION
1055 NEPPERHAN AVE • YONKERS, NEW YORK

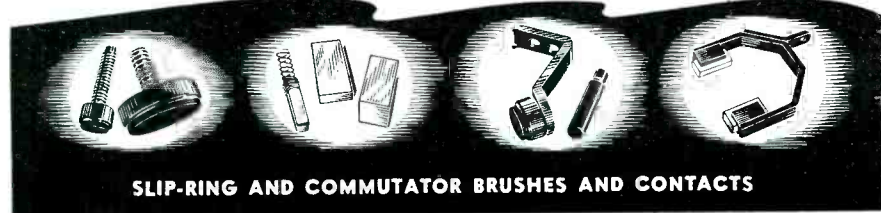

SLIP-RING AND COMMUTATOR BRUSHES AND CONTACTS

What Makes A Mailing Click?

● Advertising men agree —the list is more than half the story.

McGraw-Hill Mailing Lists, used by leading manufacturers and industrial service organizations, direct your advertising and sales promotional efforts to key purchasing power. They offer thorough horizontal and vertical coverage of major markets, including new personnel and plants. Selections may be made to fit your own special requirements.

New names are added to every McGraw-Hill list daily. List revisions are made on a twenty-four hour basis. And all names are guaranteed accurate within two per cent.

In view of present day difficulties in maintaining your own mailing lists, this efficient personalized service is particularly important in securing the comprehensive market coverage you need and want. Ask for more detailed information today. You'll probably be surprised at the low over-all cost and the tested effectiveness of these hand-picked selections.



Mc GRAW-HILL
DIRECT MAIL LIST SERVICE

McGraw-Hill Publishing Co., Inc.

DIRECT MAIL DIVISION
330 WEST 42nd ST.
NEW YORK 18, N. Y.

Company	Address	Component
Standard Transformer Corp.	1500 No. Halstead St. Chicago, Ill.	Transformers, Chokes, Reactors
Super Electric Products Corp.	1057 Summit Ave. Jersey City, N. J.	Electronic Equipment, Transformers, Switches
Supreme Instruments Corp.	Howard St. Greenwood, Miss.	Radio Testing Equipment
Sylvania Electric Products, Inc.	Emporium, Pennsylvania	Electron Tubes
Taylor Tubes, Inc.	2342 Wabansia Ave. Chicago 47, Ill.	Transmitting Tubes
Tech Laboratories	337 Central Ave. Jersey City 7, N. J.	Resistors
Thermador Electrical Mfg. Co.	5119 S. Riverside Dr. Los Angeles 22, Calif.	Transformers, Chokes, Reactors
Thordarson Electric Mfg. Div. Maguire Industries	500 West Huron St. Chicago, Ill.	Transformers Coils
Transformer Products, Inc.	143 W. 51 St. New York, N. Y.	Transformers
Translite, Inc.	639 Kent Ave. Brooklyn 11, N.Y.	Power Tubes
Trefz Mfg. Co.	38-11 Main St. Flushing, N. Y.	Resistors, Test Equipment
Triplett Electrical Instrument Co.	Harmon Road Bluffton, Ohio	Panel Instruments
Tung-Sol Lamp Works, Inc.	95 Eighth Ave. Newark 4, N. J.	Receiving and Power Tubes
Underwood Electric & Mfg. Co., Inc.	3120 W. Grand Ave. Chicago 22, Ill.	Capacitors
United Electronics Co.	54 Spring St. Newark, N. J.	Transmitting Tubes
United Transformer Co.	150 Varick St. New York 13, N. Y.	Transformers, Reactors, Filters
Universal Microphone Co.	Centinela at Warren Lane Inglewood, Calif.	
Ward Leonard Electric Co.	31 South St. Mt. Vernon, N. Y.	Resistors
Weston Electrical Instrument Corp.	614 Frelinghuysen Ave. Newark 5, N. J.	Panel Instruments
Winters & Crampton Corp.	Granville, Michigan	Capacitors

EQUIPMENT OF OWN MAKE

Company	Address
Air Communications, Inc.	2233 Grand Ave. Kansas City, Mo.
A.R.F. Products	7713 West Lake St. River Forest, Ill.
Automatic Radio Mfg. Co., Inc.	122 Brookline Ave. Boston, Mass.
Aviola Radio Corp.	703 W. Ivy St. Glendale, Calif.
Belmont Radio Corp.	5921 West Divkens Ave. Chicago, Ill.
James G. Biddle Co.	1211 Arch St. Philadelphia 7, Pa.
Allen D. Cardwell Mfg. Corp.	81 Prospect St. Brooklyn 1, N. Y.
David Bogen Co., Inc.	633 Broadway New York, N. Y.
Bruno-New York, Inc.	460 W. 34th St. New York 1, N. Y.
Communication Measurements Lab.	120 Greenwich St. New York, N. Y.
Communications Co., Inc.	2700 Ponce de Leon Blvd. Coral Gables, Fla.
Cover Dual Signal Systems, Inc.	5217 North Ravenswood Ave. Chicago, Ill.
Crosley Corp.	1325 Arlington St. Cincinnati, Ohio
Daven Co.	191 Central Ave. Newark, N. J.

Speed Your Production With This Money-Saving Automatic Inspector

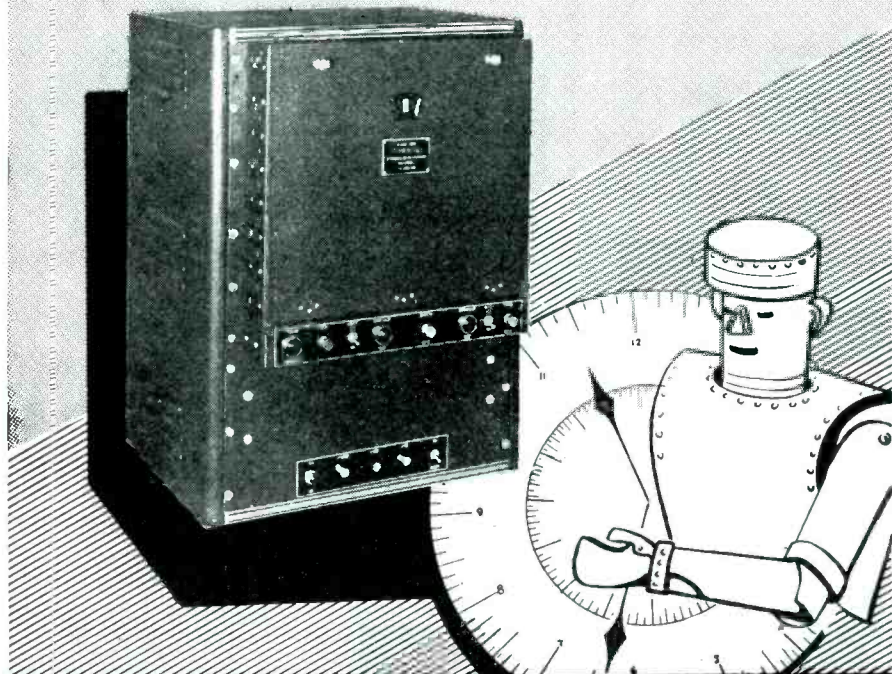

ROTOBRIDGE

Checks a Circuit a Second!

Instantaneous and accurate, the Rotobridge functions with robot-like fidelity in checking wiring errors, resistance and reactance values.

Designed for continuous 24-hour duty, the Rotobridge does your bidding exactly. Do you wish a 10% resistance tolerance at one point? A 25% capacity tolerance at another spot? The Rotobridge gives it to you — automatically and accurately.

An error detected? The Rotobridge stops cold, flashes on a red blinking signal, which winks insistently until the defect is attended to.

The Rotobridge can be put to work on several small sub-assemblies or on a complete set, involving as many as 120 circuits. Want to inspect a 30 or 40 tube set-up? Two or three of these robots, working simultaneously, will do the trick . . . in five minutes flat!

Write for complete details.

Communication Measurements Laboratory

120 Greenwich Street

New York 6, N. Y.



WARD

Antennas

FIRST CHOICE... OF AMERICA'S RADIO DEALERS

Radio dealers, too, recognize the factors that long ago made Ward Antennas most popular with auto manufacturers and dealers. They see the top quality, precision workmanship, and now the new war-created designs that make Ward better than ever! The world's finest antennas for car and home were made, are made, and will continue to be made by Ward. Place your order for Ward Antennas now!



BUY VICTORY BONDS

THE WARD PRODUCTS CORPORATION
1523 EAST 45TH STREET - CLEVELAND 3, OHIO

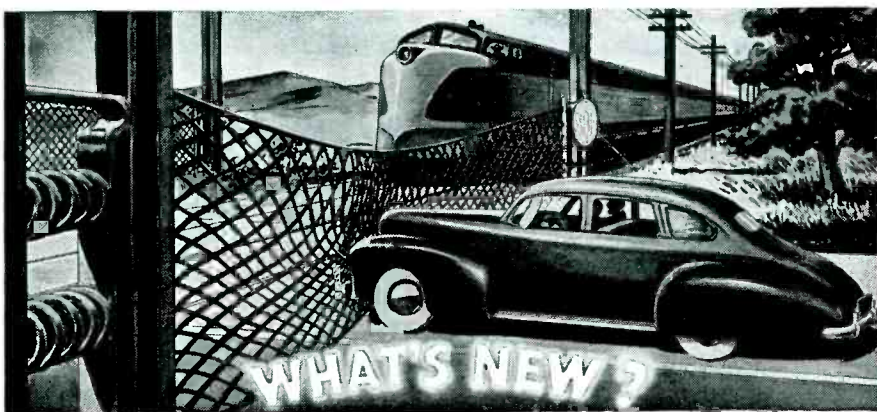

Safety Gates to Make Crossings Fool-Proof

AN INGENUOUS gate of interlacing cables has just been developed by a Mid-West inventor. Lowered automatically as the train approaches, it is sufficiently resilient to absorb contact shocks safely even at speeds of 50 miles per hour.

As industry turns from War to Peace we will witness scores of similar advances in automatic equipment depending on precision parts for efficient operation.

At Ericsson, we are always glad to consult with manufacturers who are pioneering new designs for wide markets... and whose blueprints call for parts of close tolerance that can be produced on a low-cost, mass-production basis.

(Below) Some of the many thousands of our precision parts that helped "Keep 'em flying and fighting."





ERICSSON

SCREW MACHINE PRODUCTS CO., INC.
25 LAFAYETTE STREET, BROOKLYN 1, N. Y.



Company	Address
DeWald Radio Mfg. Corp.	436 Lafayette St. New York, N. Y.
Eastern Amplifier Corp.	794 E. 140th St. New York, N. Y.
Eastern Co.	620 Memorial Dr. Cambridge 39, Mass.
Electronic Corp. o America	45 W. 18th St. New York, N. Y.
Electronic Designs, Inc.	100 Gold St. New York, N. Y.
Electronic Development Lab.	2655 W. 19th St. Chicago 8, Ill.
Emerson Radio & Phonograph Corp.	123 Duane St. New York, N. Y.
Erco Radio Laboratories, Inc.	Fenimore Ave. Hempstead, L. I., N. Y.
Fairchild Camera & Instrument Corp.	475 Tenth Ave. New York, N. Y.
Federal Telephone & Radio Corp.	591 Broad St. Newark, N. J.
Finch Telecommunications, Inc.	Fourth & Virginia Sts. Passaic, N. J.
Galvin Mfg. Corp.	4545 Augusta Blvd. Chicago, Ill.
Gates Radio Co.	220 Hampshire St. Quincy, Ill.
Globe Electronics, Inc.	295 Madison Ave. New York, N. Y.
Guided Radio Corp.	161 Avenue of the Americas New York 13, N. Y.
Hallcrafters Co.	2611 So. Indiana Ave. Chicago, Ill.
Hammarlund Mfg. Co.	460 W. 34th St. New York, N. Y.
Hewlett-Packard Co.	395 Page Mill Rd. Palo Alto, Calif.
Howard Radio Co.	1735 Belmont Ave. Chicago, Ill.
Industrial Instruments, Inc.	17 Pollock Ave. Jersey City 5, N. J.
Link Radio Corp.	125 W. 17th St. New York, N. Y.
Lorain County Radio Corp.	203 Ninth St. Lorain, Ohio
Meguire Industries, Inc.	500 Fifth Ave. New York, N. Y.
Majestic Radio & Television Corp.	2600 W. 50th St. Chicago, Ill.
J. A. Maurer, Inc.	37-01 31st St. Long Island City 1, N. Y.
E. W. McGrade Mfg. Co.	17th and May Sts. Marysville, Kansas
Megard Corp.	1601 So. Burlington Los Angeles 6, Calif.
Monarch Mfg. Co.	2014 No. Major Ave. Chicago 39, Ill.
Northern Radio Co.	2208 4th Ave. Seattle, Wash.
Packard-Bell Co.	1115 So. Hope St. Los Angeles, Calif.
Panoramic Radio Corp.	242 W. 55 St. New York, N. Y.
Pioneer Electric & Research Corp.	7216 Circle Ave. Forest Park, Ill.
Precision Apparatus Co.	92-97 Horace Harding Blvd. Elmhurst, L. I., N. Y.
Radiation Products, Inc.	1142 Wall St. Los Angeles, Calif.
Radio City Products Co., Inc.	127 W. 26th St. New York, N. Y.
Radio Controls, Inc.	110 Greenwich St. New York, N. Y.
Radio Corp. of America RCA Victor Div.	Camden, N. J.
Radio Mfg. Engineers, Inc.	300 First Ave. Peoria, Ill.
Radio Receptor Co., Inc.	251 W. 19th St. New York, N. Y.

STAR *Makes More
Than Just STEATITE*
Find Out Now About
**STAR
CERAMICS**

There are many kinds for special uses, such as applications calling for resistance to electricity, heat, moisture, chemicals or weathering agents. There are more than a score of formulas in actual production at one time in our factory.

Send for "A Brief Survey of Technical Characteristics of Molded Ceramic Products." It is right to the point.

★
**The STAR
PORCELAIN CO.**
Electronics Dept.
Trenton 9, N. J.

Electronics?

See **DONGAN** About Transformers!

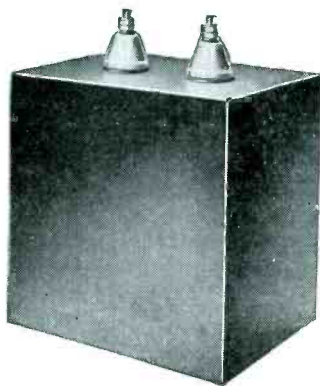

If your product requires heavy duty filter reactors, swinging reactors, or plate transformers, write us for quotation.

We are already booking orders for next year! First come—first served!

DONGAN ELECTRIC MFG. CO.
2977 Franklin Detroit 7, Mich.

**DONGAN
TRANSFORMERS**

The Dongan Line
Since Nineteen-Nine

We Invite
Inquiries

FOR

Perfection

IN PERFORMANCE
AND CLARITY OF TONE

USE —
PERFECTION Brand
SPEAKERS
embodying
ALNICO 5

PERFECTION
ELECTRIC COMPANY
829 SOUTH STATE STREET
CHICAGO 5, ILLINOIS

Blue Ribbon
A NAME WELL-EARNED

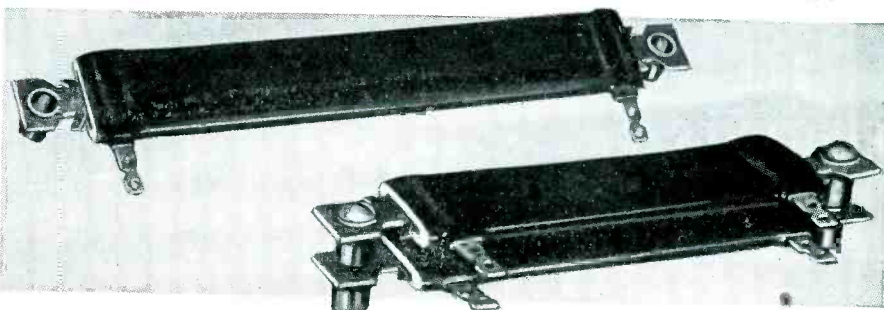

We designed our famous Blue Ribbon Resistor in 1939. It was the first flat or strip resistor in the field. Now there are others of similar type, but our Blue Ribbon still leads the field and still holds first place which its name signifies. It is compact, tough, and its remarkable performance offers you far more than just higher wattage ratings for unit space required. And our other resistors and rheostats offer you exclusive advantages also.

HARDWICK, HINDLE, INC. RHEOSTATS and RESISTORS
DIVISION OF
THE NATIONAL LOCK WASHER COMPANY
NEWARK 5, N. J. ESTABLISHED 1886 U. S. A.

Talk About PRODUCTION Without DIES!

4,000 Parts Per Day with DI-ACRO Bender

Here is an example of "DIE-LESS DUPLICATING" typical of a great variety of formed parts readily made with DI-ACRO Precision Machines,—Benders, Brakes, Shears. Picture below shows an acute right angle bend and photograph above shows the finished part formed to die precision. Women



"Enclosed pictures in our plant prove the DI-ACRO Bender will do a real production job. We are making 4,000 completed parts per day which is competitive to most Power Presses." (Name on request)

operating DI-ACRO units maintain a high out-put on production work.

Send for CATALOG

showing DI-ACRO Precision Machines and many examples of parts made with "DIE-LESS DUPLICATING." Pronounced "DIE-ACK-RU" →



O'NEIL-IRWIN MFG. CO.

321 EIGHTH AVENUE SOUTH • MINNEAPOLIS 15, MINNESOTA

Leading makes of RELAYS and SWITCHES

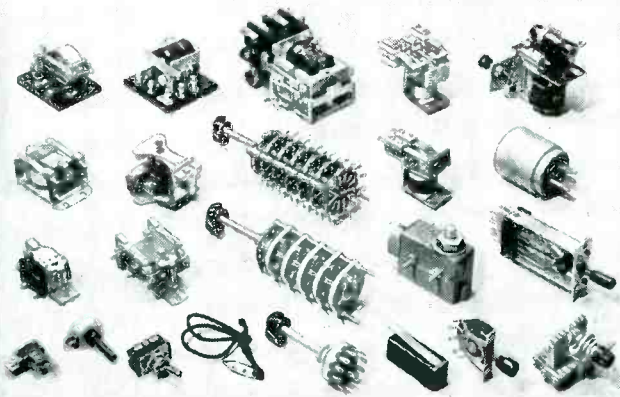

Stocks on Hand for Immediate Delivery

You get faster service from Allied, because many makes and types are centralized here—such as:

RELAYS: POTTER & BRUMFIELD—ALLIED CONTROL—EBY—GENERAL ELECTRIC—CUTLER-HAMMER—SIGMA—GUARDIAN—LEACH . . . Heavy-Duty Power; Plate Circuit, Sensitive; Overload; Keying; Antenna Transfer; Medium Duty in all Combinations of Contacts and Coil Voltages.

SWITCHES: MALLORY—CENTRALAB—CUTLER-HAMMER—HART & HEGEMAN—GENERAL ELECTRIC—FEDERAL—MU-SWITCH—ACRO—UTAH . . . Toggle, Simple Rotary; Multi-Ganged, Multi-Contact; Cam Lever Action; Mercury; Low-Pressure Actuating; Knife, Key, Button.

Save Time and Work—Call ALLIED First. Write, Wire, or Phone Haymarket 6800.

Everything in Radio and Electronics ALLIED RADIO CORP.

833 W. Jackson Blvd. • Dept. 24-M-5 • Chicago 7

Helpful BUYING GUIDE on request Write for it!

Company	Address
Rauland Corp.	4245 N. Knox Ave. Chicago 41, Ill.
Ray Energy Corp.	32 W. 22nd St. New York 10, N. Y.
Ray Jefferson, Inc.	40 E. Merrick Road, Freeport, N. Y.
Raytheon Mfg. Co.	Chapel St. Newton 58, Mass.
Reiner Electronics Co., Inc.	152 W. 25th St. New York, N. Y.
Remler Co., Ltd.	2101 Bryant St. San Francisco, Calif.
Frank Reiber, Inc.	1191 Pico Blvd. West Los Angeles, Calif.
Shallcross Mfg. Co.	Jackson & Pusey Aves. Collingdale, Pa.
Sheridan Electro-Voice Corp.	2850 S. Michigan Ave. Chicago, Ill.
Sherron Electronics Co.	1201 Flushing Ave. Brooklyn 6, N. Y.
Smith-Meeker Engineering Co.	125 Barclay St. New York, N. Y.
Solar Mfg. Corp.	285 Madison Ave. New York, N. Y.
Stromberg-Carlson Co.	100 Carlson Rd. Rochester, N. Y.
Super Electric Products Corp.	1057 Summit Ave. Jersey City 7, N. J.
Taybern Equipment Co.	120 Greenwich St. New York, N. Y.
Technical Apparatus Co.	1171 Tremont St. Boston 20, Mass.
Transmitter Equip. Mfg. Co., Inc.	345 Hudson St. New York, N. Y.
Trav-Ler Karenola Radio & Television	1036 W. Van Buren St. Chicago 7, Ill.
U. S. Television Mfg. Corp.	106 Seventh Ave. New York 11, N. Y.
United Cinephone Co.	Torrington Conn.
Vaidaphone Co.	1323 Venice Blvd. Los Angeles, Calif.
Viewtone Co.	203 E. 18th St. New York, N. Y.
Winslow Co.	9 Liberty St. Newark, N. J.

EQUIPMENT OF ANY MAKE

Aviola Radio Corp.	703 W. Ivy St. Glendale, Calif.
Belmont Radio Corp.	2633 S. Racine Ave. Chicago, Ill.
Communication Measurements Lab.	120 Greenwich St. New York, N. Y.
Electronic Corp. of America	45 W. 18th St. New York, N. Y.
Electronic Designs, Inc.	100 Gold St. New York, N. Y.
Emerson Radio & Phonograph Corp.	123 Duane St. New York, N. Y.
Federal Telephone & Radio Corp.	591 Broad St. Newark, N. J.
Hallcrafters Co.	2611 S. Indiana Ave. Chicago, Ill.
Hoffman Radio Corp.	3430 South Hill St. Los Angeles 7, Calif.
Majestic Radio & Television Corp.	2600 W. 50th St. Chicago, Ill.
Northern Radio Co.	2208 4th Ave. Seattle, Wash.
Packard-Bell Co.	1115 So. Hope St. Los Angeles, Calif.
Remler Co., Ltd.	2101 Bryant St. San Francisco, Calif.
Trav-Ler Karenola Radio & Television	1036 W. Van Buren St. Chicago 7, Ill.
Technical Apparatus Co.	1171 Tremont St. Boston 20, Mass.



For Police Cars and Other Mobile Installations



Premax Antennas

Solid Steel Oil-Tempered Antennas that will stand abuse and yet bring in the type of reception you want. Send for Bulletin 1145, showing Premax Treated Antennas and Mountings.

Premax Products

Division Chisholm-Ryder Co., Inc.
4611 Highland Ave., Niagara Falls, N. Y.

SCREWS



Just "knowing how" is not enough.

Only to a few is granted that combination of experience, organization and equipment which sets them apart as specialists.

We can rightfully claim that distinction — we are specialists in screw production. If you have a special screw problem, consult us.



MACHINE SCREWS PLASTIC INSETS
SHEET METAL SCREWS HOLDING PINS
MACHINE SCREW NUTS SPECIAL RIVETS
ALL TYPES OF HEADS AND THREADS

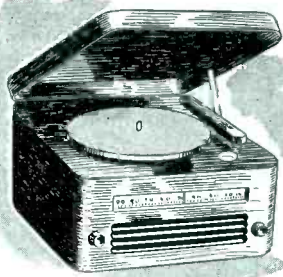

Cellusuede FLOCK HAS MANY USES IN RADIO

Both Cotton and Rayon Flock are available immediately in a variety of colors.

A trial application will show you how easily this versatile material may be handled . . . how practical it is for the above mentioned uses.

Write for Booklet, Color Card, Samples and Prices

1. Coating cabinet interiors dissipates reflections and adds acoustical qualities.
2. Coating the edges of adjoining parts before assembly eliminates vibration.
3. Coating wire grills adds a smart finish at low cost.
4. Coating phonograph turntables adds a soft non-scratching cushion for records.
5. Coating cabinet bases lends a soft velvety "feel" and protection to table and desk tops.



ALNICO-5 "MIRACLE METAL" for SPEAKERS



Cinaudagraph Speakers are known the world over for tone, stamina, engineering perfection and design. Consider the use of Alnico 5, newest miracle metal that gives 4 times the performance without weight or size increase, add this to scores of other Cinaudagraph Speaker achievements and you have the reasons why Cinaudagraph Speakers are "The Finest Speakers in all the World."

Cinaudagraph Speakers

A DIVISION OF Aireon

3911 SOUTH MICHIGAN AVENUE, CHICAGO

"The Finest Speaker in all the World"



NEW BOOKS

Table of Arc Sin X

By MATHEMATICAL TABLES PROJECT, sponsored by National Bureau of Standards, Columbia University Press, New York, N. Y., 1945, 124 pages, \$3.50.

A 12-PLACE TABLE of values of arc sin x , in radian measure, prepared as a companion volume to the values of arc tan x published by the Mathematical Tables Project in 1942. Since, for the principal value, $\arccos x = \frac{1}{2}\pi - \arcsin x$, this volume may also be used for obtaining the inverse cosine. Specifically, the function is tabulated at intervals of 0.0001 in the range between 0 and 0.9890 and at intervals of 0.00001 in the range between 0.98900 and unity.

Also included are 15-place conversion tables for changing radians to degrees, degrees to radians, minutes to radians, and seconds to radians, along with a 15-place table of multiples of $\pi/2$ up to 100.—J.M.

• • •

Principles of Radio

By KEITH HENNEY, *Editor*, ELECTRONICS. John Wiley & Sons, Inc., New York, 534 pages, \$3.50.

THIS FIFTH EDITION of a successful textbook shows promise of increasing its popularity which was well established by former editions over a period of fifteen years.

Although completely revised and brought up to date by the addition of new material on wave guides, microwaves, frequency-modulation broadcasting, klystron tubes, and other advances in the field the contents adhere to the original intention of the author, that of being written for the student who had little background in radio upon which to build and yet who wanted to know the basis on which radio communication existed. The omission in this edition of the chapters on Radio Frequency Amplifiers and Facsimile and Television in favor of new material does not detract from the continuity of the book.

While the contents are wide in scope, the various subjects have been presented in simple, understandable form. The majority of the explanations are followed by

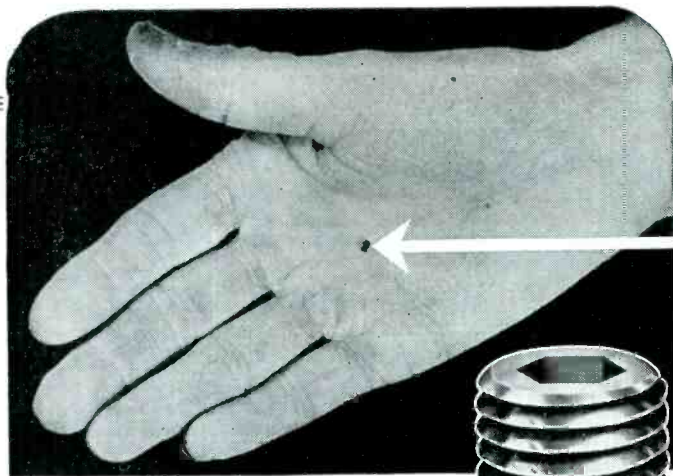

This is a #0 "Unbrako" knurl pointed self-locking Socket Set Screw.



Pat'd & Pats. Pend.



Reg. U. S. Pat. Off.



Too Small to be Effective . . . CERTAINLY NOT!

No matter how small "Unbrako" Self-Locking Socket Set Screws are, their accuracy, hardness and strength are just as outstanding as in the larger sizes. And the smaller they are, the more invaluable they become to the radio, electronics and small electrical manufacturing industries. That Self-Locking feature, provided by the knurling of the cup-point is another definite asset. These knurled points dig-in, holding tightly against all vibration. In sizes from #0 to 1" diameter — all commercial lengths. Write today for our free "Unbrako" Catalog.

Knurling of Socket Screws originated with "Unbrako" years ago.

OVER 40 YEARS IN BUSINESS

STANDARD PRESSED STEEL CO.

JENKINTOWN, PENNA.

BOX 596

Boston • Chicago • Detroit • Indianapolis • St. Louis • San Francisco

CHASSIS • CABINETS • PANELS • RACKS

Skill in **METAL**

PAR-METAL . . . a specialized manufacturing plant employing modern high-speed methods. Nevertheless, Par-Metal products have a definite quality of Craftsmanship—a "handmade" quality born of genuine skill and long experience. Write for Catalogue.



Serving the
Electronics
Field
Exclusively

PAR-METAL PRODUCTS CORPORATION

32-62—49th STREET . . . LONG ISLAND CITY, N. Y.

Export Dept.

100 Varick St., N. Y. C.



**METAL
STAMPINGS.**
IN SMALL LOTS

Die cut metal stampings in limited quantities can be produced to your special requirements at 15% to 20% of the cost of permanent type tools. No matter how small your quantity requirements or how intricate your work, we can show you a definite saving. During our twenty-three years of specialized experience in this service, there has been no other method of producing metal stampings in small lots that can equal the process originated by Dayton Rogers.

Our new, illustrated booklet #176-17 will give you full particulars.

DAYTON ROGERS MFG. CO. 2835 12th Avenue So.
Minneapolis, Minnesota

Draftsman Wanted

Also

**Designer, Detailer,
Tracer and Engineer**

We are one of the largest manufacturers of a wide variety of communication and electronic equipment in the world, fully prepared and ready to go ahead with a very ambitious, expansion program as quickly as we are permitted. There will be unlimited possibilities for creative, ambitious men to advance to key positions both in research development and production field.

Good Starting Salaries

Exceptionally fine working conditions

Apply: Personnel Office, 8 A. M. to 5 P. M.

Federal Telephone & Radio Corp.

the Mfg. unit of the International Tel. & Tel. Corp.

591 BROAD ST., NEWARK, N. J.

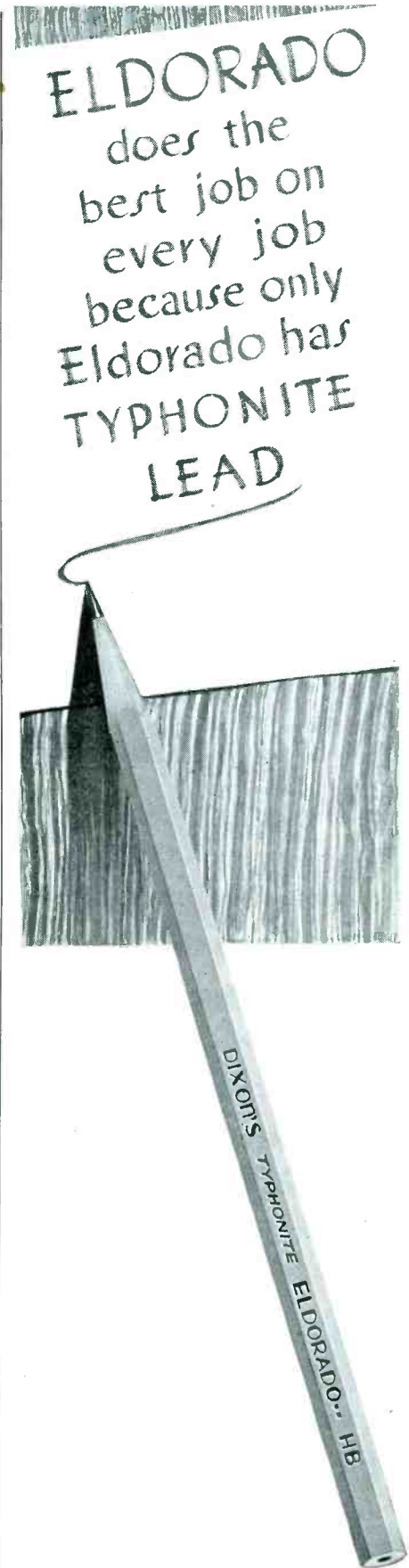

ELDORADO
does the
best job on
every job
because only
Eldorado has
TYPHONITE
LEAD

**DIXON'S TYPHONITE
ELDORADO**

PENCIL SALES DEPARTMENT 59-J12
JOSEPH DIXON CRUCIBLE CO., JERSEY CITY 3, N. J.

SUN RADIO

in
*New and larger
quarters!*

AMERICA'S

most

COMPLETE

SOURCE of

SUPPLY

Where the impossible becomes the usual. 6,000 square feet of space and a considerably enlarged staff, enable us to improve a service that has always been TOP FLIGHT.

With over 10,000 items in stock, of Standard Nationally advertised products, you have a wide selection to fill your every requirement.

Note our New Address

SUN RADIO

& ELECTRONICS CO., Inc.
122 Duane St., New York 7

Tel. BArcley 7-1840

practical examples and problems. The beginner should encounter little difficulty in gaining an understanding of the basic circuits employed in radio communication equipments.

It is noted that the author has been careful in adhering to a consistent form of abbreviation and notation. A minor objection is his refusal to make a clean break with the direction of "conventional current flow." Furthermore, it is considered unfortunate that inductors and capacitors continue to be called coils and condensers respectively. However, these do not measurably lessen the value of the book as a good basic radio textbook.—NELSON M. COOKE.

• • •

The Decibel Notation

By VEPA V. L. RAO, *Addison & Company, Ltd., Madras, India, 179 pages, \$3.00.*

TODAY THE DECIBEL UNIT is widely used in radio engineering and acoustics. In 1924, when it was first used in telephone engineering, it was called a transmission unit. In the intervening twenty years, however, very few textbook authors and technical writers have devoted their efforts to the preparation of a thorough treatment of this important mathematical artifice. To fill this void in engineering literature, Vepa V. L. Rao, radio engineer, Government of Madras, has contributed this excellent monograph, the complete title of which is "The Decibel Notation and Its Applications to Radio Engineering and Acoustics."

As presented, the definitions, mathematical operations and procedures can be easily comprehended by anyone who has studied electrical engineering. The book should serve as a valuable reference work to all who are engaged in fields associated with telecommunications and acoustics.

To orient the reader, the author begins with an exposition contrasting the precision with which pressure, temperature, sound intensity, frequency change, and intensity of illumination can be measured, with the difficulties encountered in measuring the sensations of feeling, heat, loudness, pitch, and brightness. He next surveys the develop-

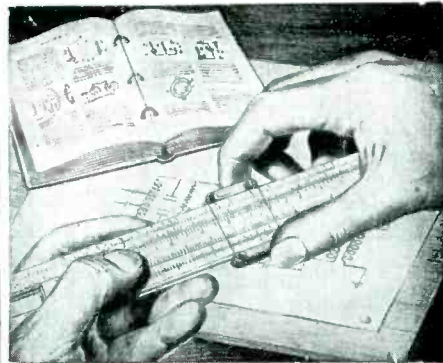

Can You Figure Out Your Own Future?

"Post-War is NOW!" Prepare now with a planned program of CREI technical training . . . get the jump on competition—get that better radio job you want—enjoy security!

NOW is the time to take the time to prepare yourself for the important, career jobs in radio-electronics engineering. You will find the knowledge gained from your CREI course useful almost from the beginning. Student C. Whitehead writes: "Your course has been of great value to me in that the knowledge I have gained has enabled me to meet technical situations satisfactorily and has given me the confidence to accept greater responsibility."

In our proved home-study course, you learn not only *how* . . . but *why!* Easy-to-read-and-understand lessons are provided you well in advance, and each student has his personal instructor who corrects, criticizes and offers suggestions on each lesson examination. This is the successful CREI method of training for which more than 10,000 professional radiomen have enrolled since 1927.

Your ability to solve tough problems on paper and then follow up with the necessary mechanical operation, is a true indication that you have the confidence born of *knowledge* . . . confidence in your ability to get and hold an important job with a secure, promising future. Investigate now the CREI home-study course best suited to your needs, and prepare for security and happiness in the New World of Electronics! *Write for all the facts today.*

• WRITE FOR NEW, FREE 36-PAGE BOOKLET

If you have had professional or amateur radio experience and want to make more money—let us help you qualify for a better radio job. TELL US ABOUT YOURSELF, so we can intelligently plan a course best suited for your needs.—PLEASE STATE BRIEFLY YOUR BACKGROUND OF EXPERIENCE, EDUCATION AND PRESENT POSITION.



CAPITOL RADIO ENGINEERING INSTITUTE

Home Study Courses in Practical Radio-Electronics Engineering for Professional Self-Improvement

Dept. E-12, 3224—16th St., N. W.
WASHINGTON 10, D. C.

Contractors to U. S. Navy—U. S. Coast Guard
—Canadian Broadcasting Corp.—Producers of
Well-trained Technical Radiomen for Industry

THERE'S A **DRAKE** SOLDERING IRON FOR EVERY TYPE OF ELECTRONIC WORK

From that mighty mite



the Drake No. 400 to the high-speed production "honey"



the Drake No. 600-10 there is a high quality Drake Soldering Iron "just right" for the job.

Drake Heat Controls and the Drake "Magic Cup" Stand are important soldering aids.



SEE
YOUR RADIO
PARTS JOBBER

DRAKE ELECTRIC WORKS, INC.
3656 LINCOLN AVE. CHICAGO, ILL.

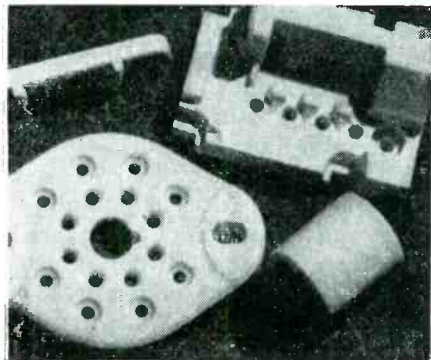

Lavite STEATITE CERAMIC

Properties and Characteristics of Our
LAVITE SI-5 Steatite Ceramic Body

Compressive Strength	96,000 lbs. per square inch
Tensile Strength	7,200 lbs. per square inch
Flexural Strength	10,500 lbs. per square inch
Modulus of Rupture	20,000 lbs. per square inch
Dielectric Strength	235 volts per mil
Dielectric Constant	6.42
Loss Factor	2.90
Power Factor	446
Bulk Specific Gravity	2.664
Density (from above gravity)	0.096 lbs. per cubic inch
Hardness (Mohr scale)	7.0
Softening Temperature	2,350°F.
Linear Coefficient of Expansion	8.13x10 ⁻⁶
Moisture Absorption (ASTM D-116-42-A)	0.009%

Design engineers and manufacturers in the radio, electrical and electronic fields are finding in LAVITE the precise qualities called for in their specifications... high compressive and dielectric strength, low moisture absorption and resistance to rot, fumes, acids, and high heat. The exceeding low loss-factor of LAVITE plus its excellent workability makes it ideal for all high frequency applications.

We will gladly supply samples for testing.

D. M. STEWARD MFG. COMPANY
Main Office & Works: Chattanooga, Tenn.
Needham, Mass. Chicago Los Angeles

COMPLETE CLOSURES AND MULTIPLE HEADERS!



PROMPT DELIVERY NOW ON COMPLETE ENCLOSURES AND MULTIPLE HEADERS

E-1 multiple headers and complete component closures are now available for fast delivery. Square closures are supplied with any number of contacts up to 14. Round closures are furnished up to a maximum of 8 contacts. The terminals are brought out through sealed headers and header bridges can be incorporated for component mounting in the can interior. Plug in headers are included. Can lengths to 6 inches inclusive, are standard. For complete details of E-1 hermetically sealed multiple headers write today for the new comprehensive six-page E-1 folder.

Round can closures are supplied with up to 8 contacts. Can lengths to 6 inches available.

Square can closures are furnished with any number of contacts up to 14 maximum.

**ELECTRICAL
INDUSTRIES • INC**
42 SUMMER AVENUE
NEWARK 4, NEW JERSEY

AIRCO GAS PROPORTIONER

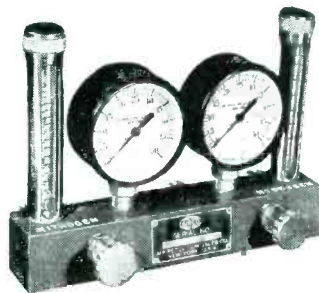

CONVENIENT—ACCURATE GAS MIXING DEVICE

Designed to meet the needs of electronic tube manufacturers using gas mixtures for protective atmospheres, this new Airco development produces an accurately proportioned mixture at a pressure not in excess of 5 psi. A complete line of flowmeters is available to permit flows of hydrogen from about 2 to 200 cfh. and of nitrogen from about 6 to 140 cfh.

For full details, write today for a descriptive folder (ADI-892). Address:

AIR REDUCTION

60 East 42nd Street
New York 17, N. Y.



OFFICES IN
PRINCIPAL CITIES

In Texas: Magnolia Airco Gas Products Company
Gen'l. Office: Houston 1, Texas
Represented Internationally by Airco Export Corp.

ELECTRONICS to your order!

Veterans of pre-war and wartime electronics, we serve aviation, marine and related companies to C. A. A. and F. C. C. standards. Ask us...

To DESIGN, DEVELOP and MANUFACTURE ...

Radio Receivers and Transmitters
Industrial Electronic Equipment
Airport Radio Control Equipment
Marine Radio Telephone Equipment

Your inquiries will receive immediate action

**ISLIP RADIO MFG.
CORPORATION**

ISLIP, L. I., NEW YORK



N-LINE INSPECTION

guarantees performance

All of the engineering and production facilities of the Potter & Brumfield Mfg. Co. are devoted to the manufacture of electric relays. This intense specialization has enabled them to develop practical procedures of inspection at important assembly points. Each individual relay is carefully tested for every critical value right in the assembly line.

This complete and thorough inspection procedure guarantees dependable and reliable service from every Potter & Brumfield relay you buy. Relays play an important part in the successful operation of your equipment. . . . IT PAYS TO BUY THE BEST.

For complete information and specifications on Potter & Brumfield relays, write for catalog.

Potter & Brumfield MANUFACTURING CO., INC.

105 NORTH 10TH STREET, PRINCETON, INDIANA

IN-RES-CO RESISTORS

**Close tolerance units for
precision performance**

IN-RES-CO resistors are engineered to meet all important electronic application needs. They are wire wound for permanent, exact resistance value and both inductive and non-inductive types are standard. Standard tolerances are 1 and 2%—closer tolerances on special order. Rigid quality control assures a uniform standard of excellence and modern manufacturing facilities result in low unit cost and prompt delivery. Manufacturers of electrical and electronic instruments and equipment should investigate the advantages of designating IN-RES-CO as their exclusive wire wound resistor source.

TYPES RN AND SN Tropi-pruf resistors—
RN: 3/4" long x 5/8" dia., Max. Res. 1/2 Megohm, 1/2 watt; SN: 1-3/16" long x 5/8" dia., Max. Res. 1 Megohm, 1 watt



INSTRUMENT RESISTORS CO.

25 AMITY STREET, LITTLE FALLS, N. J.

ment of the neper, bel, and decibel units, and then establishes their conversion relationships. The decibel notation and its formulas that relate to electrical quantities like power, voltage and current are explained.

Following a discussion and definition of the important terms used in acoustics, the phon or loudness unit is introduced and its development traced. For a plane progressive wave, comparative values are given in tabular form, for the intensity level, phons, corresponding effective value of pressure fluctuations, and sound particle velocity. The zero phon loudness level is defined and a comparison made of the loudness levels in phons of the thresholds of hearing, feeling, and pain.

In showing how the decibel notation is used in radio engineering and acoustics, the author takes the opportunity to describe the principles underlying the use of many well known devices and their characteristics. The applications include the output power meter, audio amplifiers, radio receivers, audio transformers, gramophone record cutters and pickups, output tubes, microphones, loudspeakers, transmitters, transmission lines and feeders, antennas, studio acoustics, attenuators, equalizers, and filters.

An appendix is devoted to a description of the types of graphs used in radio and acoustic engineering, an explanation of the logarithmic notation and its limitations, a discussion of the differences between the British and American standard cables, and a statement of the laws of logarithms with tables of common logarithms and anti-logarithms.—J.K.

The Electrolytic Capacitor

By ALEXANDER M. GEORGIEV, *Murray Hill Books, Inc., New York 16, N. Y., 191 pages, \$3.00.*

ENGINEERS WHO DESIGN and develop electrical apparatus and products that make use of electrolytic capacitors will appreciate the broad scope of this book. The well-balanced presentation of fundamental principles and practical considerations is convincing evidence that the author is an authority in this field.

The author has drawn exten-

RAWSON TWIN MULTIMETER

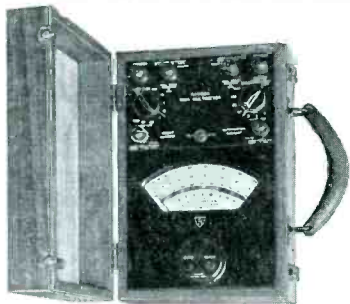

Type 5012 Accuracy $\frac{1}{2}$ of 1% DC
Size 12"x8"x6" 1% AC

A Combination AC, Multimeter and DC
Multimeter

Range of Measurements

DC 1 microampere to 1 Ampere.

20 Microvolts to 1000 volts.

AC (thermocouple type)

2 Milliamperes to 3 Amperes.

60 Millivolts to 1000 volts.

Write for bulletin

WE ALSO SUPPLY

REGULAR DC METERS

THERMOUPLA AC METERS

MULTIMETERS

FLUXMETERS

ELECTROSTATIC VOLTMETERS

Special apparatus built to order

RAWSON ELECTRICAL INSTRUMENT COMPANY

111 POTTER ST. CAMBRIDGE, MASS.

Representatives

CHICAGO

NEW YORK CITY

Announcement

Bowser, Inc. and Kold-Hold Manufacturing Company are pleased to announce that the sub-zero industrial equipment formerly manufactured by the Kold-Hold Manufacturing Company will in the future be manufactured and sold exclusively by Bowser, Inc.

Kold-Hold Manufacturing Company will devote its entire facilities to the manufacture of evaporator plates and cabinet liners.

BOWSER, INC., Woodside, Long Island
KOLD-HOLD MANUFACTURING CO.,
Lansing, Michigan



In future peace-time production, Radex will uphold its war-won reputation by the scope and caliber of its service to the radio and electrical industries.

Radex Corporation

53 W. Jackson Blvd., Chicago 4, Ill.

INDICATOR LAMPS

Indicate and identify circuit operations on radio transmitters and electronic devices. Lock-on caps, available in five different colors, cannot shake loose. Caps and bases of sturdily constructed molded plastic. Easy to mount. With or without "dim-out" feature. For further details write

Electronics Department, General Electric, Schenectady 5, N.Y.

GENERAL ELECTRIC
177-DL-1

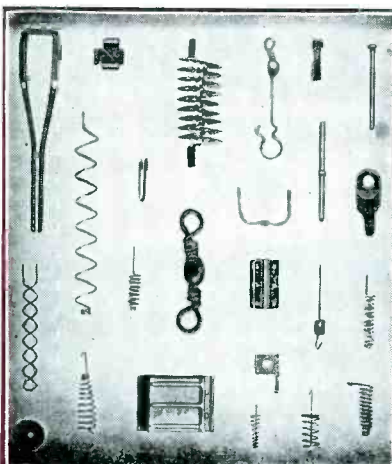

SMALL PARTS

Filaments, anodes, supports, springs, etc. for electronic tubes. Small wire and flat metal formed parts to your prints for your assemblies. LUXON fishing tackle accessories, double pointed pins, fine sizes wire straightened. Inquiries will receive prompt attention.

**ART WIRE AND
STAMPING CO.**

227 High St.

Newark 2, N. J.

ANTENNAS

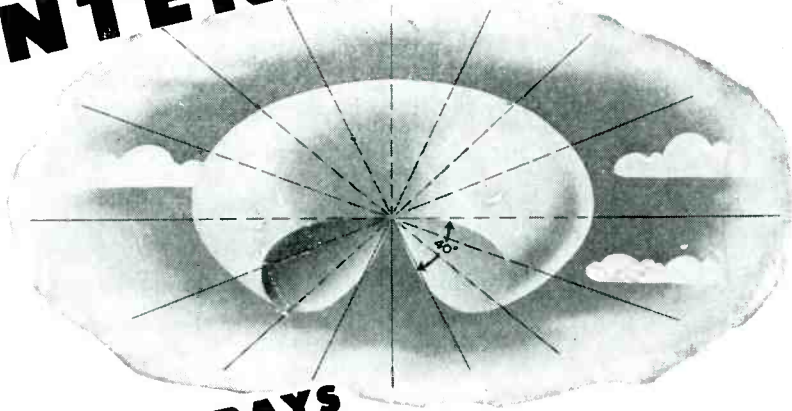

BEACON ARRAYS

The design of a beacon array necessary to produce a predetermined pattern involves many factors not easily reconciled to each other. The exacting techniques developed at the Workshop during the war for readily controlling these factors makes it possible for us to meet the most rigid specifications. Manufacturers who require beacon arrays, or any other type of antenna to operate in the high frequency spectrum—from 30 mc up—will find our exceptional measurement and test facilities well-adapted to a quick solution of their problems. Just write, or phone the details.

The **WORKSHOP ASSOCIATES**

Antenna Manufacturers FOR THE ELECTRONIC INDUSTRY
66 NEEDHAM STREET, NEWTON HIGHLANDS 61, MASSACHUSETTS



sively from his observations and experiences acquired in the development and manufacture of capacitors. He describes the construction, manufacture, function, and testing of dry and wet electrolytic capacitors, explains the operating characteristics of the various types, and indicates both their useful applications and their limitations.

Several theories are outlined concerning the nature of the dielectric film, and the properties of the film treated in detail. Film-forming electrolytes that are generally used in the electrolytic capacitor industry are thoroughly surveyed as well as those employed in other branches of the anodizing process. The batch method and the continuous method, and associated equipment, used in the formation of capacitor anodes are set forth.

Much detailed and useful information is included in the chapters dealing with chemical and electrochemical methods of etching aluminum electrodes to increase capacitance, properties of papers suitable for electrode spacers in dry electrolytic capacitors, properties and requirements of materials used for the operating electrolyte, precautions and considerations that must be observed in winding capacitor sections and their connections if satisfactory performance is to be obtained, factors governing the effectiveness of the impregnation and precautions necessary to produce desired results, methods of impregnating dry capacitors and their respective advantages and drawbacks, and the requisites for an efficient container including a discussion on methods of venting the assembly.

For the laboratory technician and the maintenance man, chapters are included that cover electrical measurements, routine tests and special tests for electrolytic capacitors, causes and detection of troubles, emergency repairs, and replacements.

Of special interest to designers of electrical apparatus and assemblies are the sections devoted to the choice of type and design of electrolytic capacitors as governed by expected operating conditions, available space for mounting, permissible weight, cost, and similar factors, trends in the development of electrolytic capacitors during the

RADIO

PRODUCTION
and REPRODUCTION

will be better because of

MONARCH

MEASURING • TESTING • CALIBRATING
EQUIPMENT



2014 N. MAJOR AVE. • CHICAGO 39, ILL.

HIGH VACUUM!

Our complete and modern equipped high-vacuum and glass-working laboratory is now available for conducting work on special research and experimental problems or for the manufacture of special high-vacuum devices of all kinds to your specifications.

Experienced technicians are available for work on:

HIGH VACUUM AND GASEOUS DISCHARGE TUBES

Ionization Gauges, Pirani Type Gauges, Vacuum Thermocouples and T.C. Gauges, Bolometers, using Wollaston or Fine Wires, Spectroscopic Research, Discharge Tubes, Geiger Counters, Mass Spectograph Tubes, Etc.

EVAPORATING AND SPUTTERING TECHNIQUES

SCIENTIFIC AND LABORATORY GLASS APPARATUS

In Soft Glass, Pyrex and Quartz.

We Welcome Your Inquiries

BALLANTINE LABORATORIES, INC.
Bocnton, New Jersey



Streamlined

... in appearance
... in assembly

ELECTRIX PLUGS offer

- ⊗ Superior features of mechanical design
- ⊗ Quick, easy assembly
- ⊗ Lowest cost per finished unit

ELECTRIX
Corporation

140-158 MIDDLE STREET
PAWTUCKET • RHODE ISLAND

UNITED STATES RUBBER COMPANY
Exclusive Selling Agents

JOB AHEAD

... and we're equal to it!
Each day we are shipping more for civilian use.



WIRES

MADE BY *Engineers*
FOR *Engineers*

cornish
WIRE COMPANY, INC.

15 Park Row,
New York City

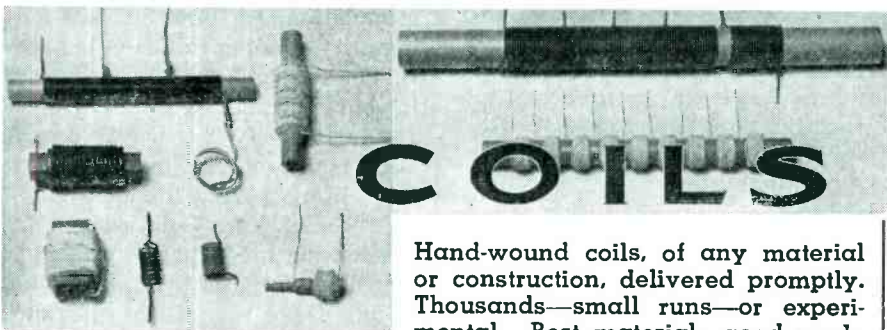

COILS

Hand-wound coils, of any material or construction, delivered promptly. Thousands—small runs—or experimental. Best material—good workmanship. Send prints or specifications for quotation. State delivery requirements.

BITTERMANN ELECTRIC CO.

50 Henry St. Brooklyn, N. Y.
TRiangle 5-4767

"If it's a COIL—We'll Make It"



CUP WASHERS
for Binding Screws

WHITEHEAD STAMPING CO.

1691 W. Lafayette Blvd.

Detroit 16, Michigan



Preferred

as a source of precision - made WASHERS and STAMPINGS manufactured to your specifications

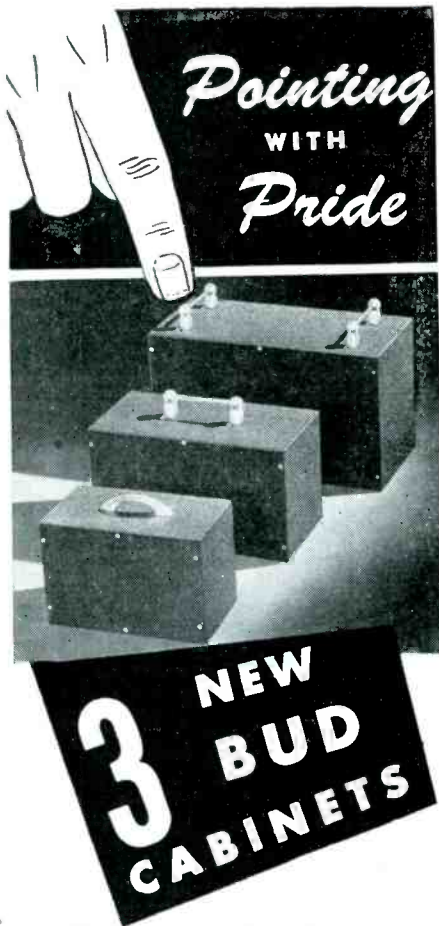

Modern . . . attractive . . .
and twice as useful!

This new series of BUD Portable Steel Utility Cabinets has innumerable uses in laboratories, factories, and ham shacks. BUD takes pride in presenting these new cabinets knowing they reach a new high in appearance while providing even finer operation for the equipment that is housed within them.

Cabinets are extremely useful for portable or fixed electronic test equipment, small transmitters and receivers, field strength meters, or for other applications requiring a cabinet of outstanding appearance and durability.

Front and rear panels are removable for easy access to interior.

CC-1091 Size 5" x 6" x 9" has a streamlined chrome handle.

CC-1092 Size 6" x 7" x 12" has a "FULL GRIP" handle.

CC-1093 Size 7" x 9" x 15" has two "FULL GRIP" handles.



last twenty years, and applications and uses for electrolytic capacitors in radio receivers, electrical apparatus, and induction motors.

An informative glossary having eight pages of pertinent technical terms and nomenclature is included, along with an excellent bibliography of reference books and periodicals and a long list of United States and foreign patents.—J.K.

• • •

Willis Rodney Whitney

By JOHN T. BRODERICK. *Fort Orange Press, Inc., Albany, New York, 324 pages, \$3.00.*

IN THE FOREWORD of this book, Karl T. Compton states "Few scientists have so impressed their ideals upon their contemporaries and followers as has Willis R. Whitney. He has largely set the pattern and philosophy of the modern industrial research laboratories, one of the unique achievements of this century. That Whitney was able to do this may be explained very simply; he was the right man at the right place at the right time.

"I am one of the many scientists to whom Dr. Whitney's intellectual stimulation, complete honesty and humility, abiding faith in the scientific method and unbounded interest in young men have been a continued inspiration. I am therefore glad that many others may come to know him through this biography."

Much of this interesting and fascinating biography is related in the dual form of narration—first telling the story of an individual and then letting him speak to the reader for himself in his own words—his own testimony concerning himself and his own interpretation, direct and in sidelights, of the work to which his life has been dedicated.

The author has not attempted to present an elaborate biography, but instead has produced a narrative sufficiently restrained to be in keeping with the character of its subject and yet extended enough to familiarize a reader with the career of a man who, as much as any other single individual, has made physical research both fascinating and fruitful.

Records of conversations and some typical Whitney writings supplement this picturesque volume. In these pages the doctor tells in his

NOW! MAKE PHOTO-COPIES OF ANYTHING

in your own office—quickly, accurately, at low cost!



Photo-Copier
\$55
Copies up to
18" x 22"

Also continuous cabinet models for prints of any length, up to 12" wide.

Copies Anything! With this modern equipment in your office or plant, you can get photo-exact copies of anything written, typed, printed, drawn or photographed—even if on both sides! No waiting—no costly *doing without* copies you need. APÉCO safeguards valuable originals—delivers copies at 1-a-minute speed, for less than the cost of a phone call to an outside source of photocopying!

Expedites Work in Every Department! Executives, in a nation-wide survey, reported 137 tested uses for APÉCO—uses for every department of your business, that speed work, save typing and drafting time.

Permanent, Error-proof! APÉCO can't make mistakes. You get legally accepted copies—with no proof-reading or steno-copying required.

Any Boy or Girl Can Operate It! No film, no camera, no focusing—no dark-room or technical knowledge needed. It's so easy that anyone can learn to operate it in a few minutes!

Send for your free copy of this informative book



... tells how APÉCO photocopying can serve you

See how you can save time, money, labor, and expedite work with this most modern method of copying. APÉCO'S interesting, 20-page, fully illustrated book gives you the story of Photocopying—shows graphically the "what" and "how" of this amazingly simple procedure. Yours for the asking—no strings attached. Write for your copy, today.

AMERICAN PHOTOCOPY EQUIPMENT CO.
2849 North Clark St., Dept. AG-125, Chicago 14, Illinois
Representatives in principal cities and Canada

The **APÉCO**
PHOTOEXACT
"Copies Anything!"

AMERICA'S MOST WIDELY USED
PHOTOCOPY EQUIPMENT
DRYERS • TRAYS • PAPER • CHEMICALS
TIMERS • AND OTHER PHOTOCOPY
SUPPLIES

- BLUE PRINTS
- PENCIL SKETCHES
- LETTERS
- SPECIFICATIONS
- TRACINGS
- DIAGRAMS
- GRAPHS
- CHARTS
- (OVER 100 OTHERS)

Use C. T. C.'s NEW TIME-SAVING All-Set TERMINAL BOARDS

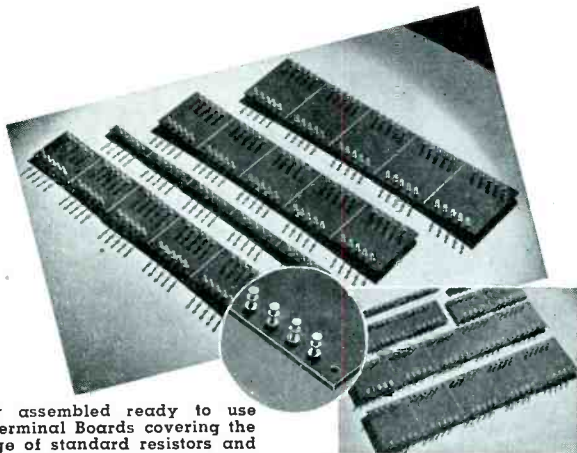

Completely assembled ready to use Mounted Terminal Boards covering the entire range of standard resistors and condensers. Specially designed for experimental laboratories and manufacturers to speed development of model equipment and assembly of established products. C.T.C. All-Set Terminal Boards are made of 3/32", 1/8" and 3/16" linen bakelite only and are available in four widths 1/2"; 2" (lug row spacing 1 1/2"); 2 1/2" (lug row spacing 2"); 3" (lug row spacing 2 1/2").

Made in five-section boards which can be broken into fifths by bending back on scribed line. Each fifth is drilled for twelve lugs. Available in sets of four widths, or in lots of 6 or multiples of 6 in any single width. Extra lugs and stand-offs supplied. C.T.C.'s new All-Set Terminal Boards can be supplied with any size C.T.C. Turret Terminal Lug—as listed in catalog #100, drawing #1724.



WRITE FOR C.T.C. CATALOG NO. 100
CAMBRIDGE THERMIONIC CORPORATION
439 Concord Avenue • Cambridge 38, Mass.

Teach yourself MATHEMATICS for big new jobs in radio television radar

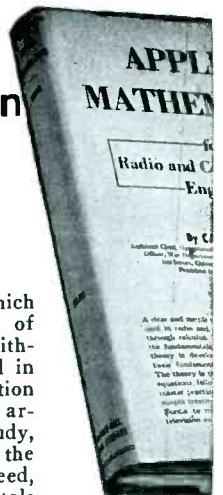

Here's the manual which can make you master of mathematics, from arithmetic to calculus, used in radio and communication engineering. Especially arranged for home study, the book gives all the mathematics you need, from basic fundamentals to more detailed concepts—to help you get ahead in radio, television, frequency modulation, radar development.

Just Published!

APPLIED MATHEMATICS

For Radio and Communication
Engineers

By **CARL E. SMITH**

Assistant Chief, Operational Research Branch, Office of the Chief Signal Officer, War Department; Development and Research Engineer (on leave), United Broadcasting Co., Cleveland.

336 pages, 5 1/4 x 8 1/4, \$3.50

You will find it easy to learn by yourself through this method of presentation. Useful design equations are solved in the text, and 150 exercise problems help you build a sure working knowledge of each subject. There is a simplified treatment of calculus and the last chapter on series and wave forms meets the modern trends to frequency modulation, television and radar development. An unusually full appendix of useful charts and tables contains all necessary reference material.

CHAPTERS

Arithmetic	Quadratic Equations
Logarithms	Hyperbolic Trigonometry
Algebra	Differential Calculus Treat-
Geometry	ing Algebraic Functions
Trigonometry	Differential Calculus Treat-
Vector Addition	ing Transcendental func-
Complex Quantities	tions
Curves and Graphs	Integral Calculus
Simultaneous Equations	Series and Wave Forms

Includes 97 figures, 20 tables and charts. The presentation has been streamlined to include only the subject matter most useful in the field of radio and communication engineering.

See it 10 days—Send coupon

McGraw-Hill Book Co., 330 W. 42nd St., N.Y.C. 18
Send me Smith's Applied Mathematics for Radio and Communication Engineers for 10 days examination on approval. In 10 days I will send \$3.50, plus few cents postage, or return book postpaid (postage paid on cash orders.)

Name

Address

City and State

Company

Position L 12-45

GASES

HYDROGEN NITROGEN · OXYGEN

COMPLETE GAS PRODUCTION PLANTS INSTALLED FOR LOWEST COST OPERATION

FORMING MIXTURES
CARBON DIOXIDE
ACETYLENE

HIGHEST QUALITIES • ANY QUANTITY DELIVERED ANYWHERE

AMERICAN GAS & CHEMICAL CO.

HARRISON, NEW JERSEY • Contracted Complete Service on All Gases

ARGON · NEON
HELIUM · KRYPTON
XENON

C&D 1

PERMANENT MAGNETS

All Shapes—All Sizes—for All Purposes
COBALT—CHROME—TUNGSTEN
Stamped, formed and cast

Alnico (Cast or Sintered)

Also: Laminations for Radio Transformers
TOOLS—DIES—STAMPINGS
Heat Treating of Metals and Alloys

THOMAS & SKINNER STEEL PRODUCTS COMPANY
1116 EAST 23RD STREET • INDIANAPOLIS 5, INDIANA

Polyweld

MORE THAN A CEMENT
... It welds!

Amphenol Polyweld is the perfect solder dope for R.F., U.H.F. and V.H.F. applications... applied by brush or dipping... no baking needed.

Amphenol Polyweld "912" is pure polystyrene in solution. Will not disturb circuit

constants when used on coils, ceramics, wire or insulation... Polyweld is the finest protection for all types of coils—plus a perfect cement.

Amphenol Polyweld is available in 30 gallon drums—also in smaller containers. Write for special folder of Polyweld characteristics.

AMERICAN PHENOLIC CORPORATION

Chicago 50, Illinois

In Canada • Amphenol Limited • Toronto

U. H. F. Cables and Connectors • Conduit • Fittings • Connectors (A-M., U. H. F., British.) • Cable Assemblies • Radio Parts • Plastics for Industry.



Integrity of Design

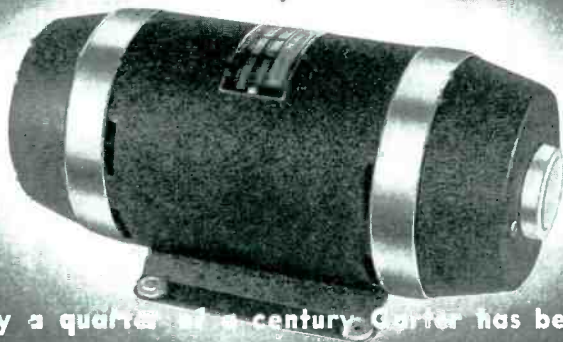

For nearly a quarter of a century, Carter has been a well known name in radio and has led the industry in designing and manufacturing the finest Rotary Electrical Power Supplies.

The preference and specification of Carter Products is an attribute to their precision performance and integrity of design. Write for latest catalog today.

Carter Motor Co.

Chicago, Illinois

1606 Milwaukee Ave. Carter, a well known name in radio for over twenty years. Cable: Genemotor

own language the story of his life and activities, sometimes with homespun humor, sometimes with deep seriousness, but usually with a novel, inspiring and instructive message.

The narrative is not confined solely to the objectives of pure research and the values derived therefrom. It also deals with the relation of research to atoms and electrons, biology and physiology, education and religion, technological progress and industrial promotion, human life and turtle life, and the wide range of subjects that have engaged Dr. Whitney's attention as an assiduous student and original thinker.

This authentic record of Whitney's experiments, methods of work, ideas and practical accomplishments should be educational for readers, young or adult, who are ambitious to give their energies full and effective play but do not know what they are best fitted to do.

Mr. Broderick has contributed to our literature not only a vivid, graphic account of the activities and philosophy of one of the outstanding scientists of our time, but also a lucid explanation of the benefits that have been bestowed upon civilization by the research work conducted by modern men of science.—J.K.

• • •

ELECTRONIC STOP WATCH

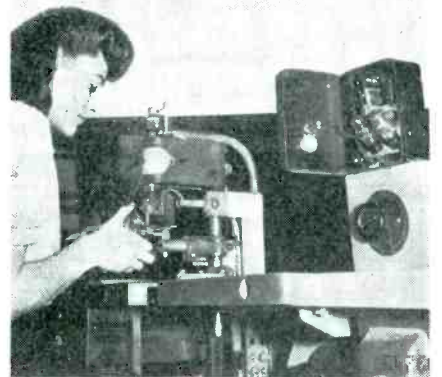

For the relatively small welding currents required in assembling internal structures of radio tubes, the switchbox-size RCA electronic interval timer at the upper right provides a simple and positive method of control. The timing is controlled by an R-C network in the grid circuit of a vacuum tube, and can be varied as required for different thicknesses of metal by changing the setting of the rheostat on the cover of the timer.

**RADIO
HARDWARE**
*Wires and
Cables*

Quality
since 1923

... also pioneers
in the design and
manufacture of

Ceramic, Porcelain & Steatite Insulators, Antennas, Hook-Up Wires, Shielded Microphone Cable and S. J. Cable.

Specify and use
"Birnbach" products.
Complete Stock at
your jobber

BIRNBACH RADIO CO., Inc.
145 HUDSON ST. NEW YORK, 13, N. Y.

Why **POTTER**
TRANSMITTING CAPACITORS
**ARE PREFERRED FOR
RELIABILITY**

Over 20 years of specialized engineering concentration, design and construction accounts for the outstanding reputation of POTTER Capacitors for dependable performance under most exacting requirements.

War-time records have thoroughly justified the selection of POTTER Capacitors for U. S. military and naval equipment. POTTER Capacitors are contributing to the supremacy of our newest fighting machines under every demand and emergency.

The superiority of POTTER Oil-Filled Capacitors of conservative design rating, and high safety factor is evidenced by their performance wherever used. They are capable of withstanding wide range of temperatures and operating conditions. All official specifications complied with. All standard and special mountings available.

Special Capacitors of all types for every purpose.

Send us your Specifications for Prompt Service!

THE POTTER COMPANY
ESTABLISHED 1925
1950 SHERIDAN ROAD, NORTH CHICAGO, ILLINOIS

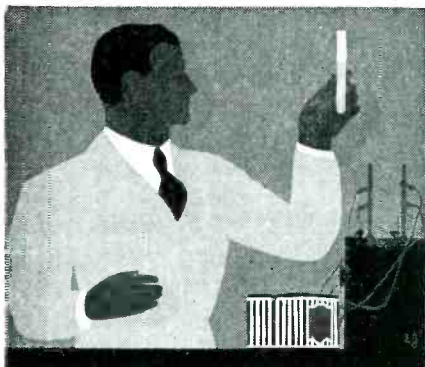

*Accuracy
in Washers*

Especially important in electrical products,
where VIBRATION is an enemy.

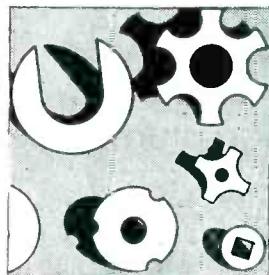

QUADRIGA QUALITY WASHERS

Made exactly to your specifications for greatest precision.
PROMPT DELIVERY any washer material, any type, any quantity, large or small.

Also SMALL METAL STAMPINGS, any design.

Send for QUADRIGA Catalog

Many photographs. Valuable engineering data.

THE QUADRIGA MANUFACTURING CO.

Incorporated 1894
WASHERS & SMALL METAL STAMPINGS
221A West Grand Ave. • Chicago 10, Illinois



PREFERRED
BY ENGINEERS

**BURGESS
BATTERIES**

RECOGNIZED BY THEIR
STRIPES • REMEMBERED
BY THEIR SERVICE

NORCO COAXIAL TRANSMISSION LINES
AND FITTINGS

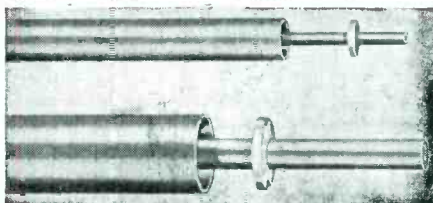

NORCO coaxial cables, of the rigid gas filled type, for radio communication, radar, television, and FM. A complete line of fittings, both solder, and improved solderless types can be supplied for NORCO Transmission Lines, including improved End Seals and Junction Boxes. Your inquiry invited.

NORTHERN COMMUNICATIONS MANUFACTURING CO.

210 EAST 40th STREET NEW YORK 16, N. Y.
Manufacturers of Transformers • Special Coils • Reactors • Sound Systems
Recorders • Equalizers • Full Range Phonograph • Coaxial Transmission Lines

MODEL 2405

Volt • Ohm Milliammeter

25,000 OHMS PER VOLT D. C.

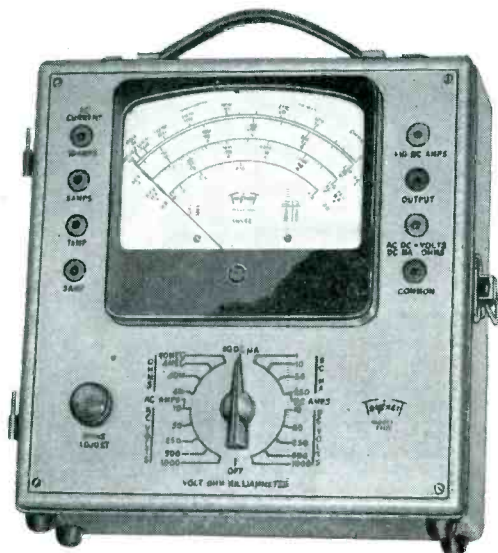

NEW ENGINEERING NEW DESIGN • NEW RANGES 30 RANGES

- Voltage: 5 D.C. 0-10-50-250-500-1000 at 25000 ohms per volt.
- 5 A.C. 0-10-50-250-500-1000 at 1000 ohms per volt.
- Current: 4 A.C. 0-.5-1-5-10 amp.
- 6 D.C. 0-50 microamperes—0-1-10-50-250 milliamperes—0-10 amperes.
- 4 Resistance 0-4000-40,000 ohms—4-40 megohms
- 6 Decibel -10 to +15, +29, +43, +49, +55
- Output Condenser in series with A.C. volt ranges

STANDARDS ARE SET BY



SPECIFICATIONS

NEW "SQUARE LINE" metal case, attractive tan "hammered" baked-on enamel, brown trim.

■ PLUG-IN RECTIFIER — replacement in case of overloading is as simple as changing radio tube.

■ READABILITY—the most readable of all Volt-Ohm-Milliammeter scales—5.6 inches long at top arc.

Model 2400 is similar but has D. C. volts Ranges at 5000 ohms per volt.

Write for complete description

Triplet

ELECTRICAL INSTRUMENT CO.

BLUFFTON OHIO

Backtalk

This department is operated as an open forum where our readers may discuss problems of the electronics industry or comment upon articles which ELECTRONICS has published.

Slow-Motion Tele

DEAR MR. HENNEY:

IT SEEMS YOU just can't keep a dead dog buried. After everyone agrees to the fact that you can only transmit a given amount of intelligence by means of a system of a given bandwidth in a certain limited time, and while the fight is on as to whether or not to call it the Hartley Law, Palmer Craig pops up with a suspicion that it just ain't so.

I think that Mr. Craig's proposed exception can be shown to be quite invalid with a moment's thought. The television system that I think he describes has been put forward before, and has never been of any practical use. Let's consider just one out of the 240,000 elementary areas. The information determining the density of this area would have to be passed through a narrow-band filter; in the example given this filter is one-quarter cycle wide.

Now it is a well known fact that the amplitude of a wave passing through a band-pass filter can be changed at a maximum rate deter-

• • •

RADAR ANTENNAS



Now it can be told. Above, the forward detection antenna blister and one of the side blisters in the land-based patrol bomber, the Privateer PB4Y-2

W



Let us tell you—
about our unusual
PLASTICS SERVICE
to Manufacturers

SEND FOR NEW CATALOG

WATERBURY

MOLDINGS OF MERIT

*Compression
Transfer
Injection*

WATERBURY COMPANIES, INC.
FORMERLY WATERBURY BUTTON CO., EST. 1812
MCGRAW AVE., WATERBURY, CONN.

2 VITAL AIDS

TO THE MANUFACTURER OF
Miniature Tube Radios

★ **STAR**



DOUBLE-CHECK SYSTEM

#JE-10—Miniature socket wiring plug for accurate alignment of miniature socket contacts during wiring. Precision cast of zinc base alloy—Pins of stainless steel.

#JE-12 — (Hardened tool steel insert) or JE-13 (Stainless steel insert) Miniature tube pin straightener to obtain a perfect fit when the tube is placed in the set.



For complete information and prices—write

RADIO ACCESSORY DIVISION

STAR EXPANSION PRODUCTS CO.
147 Cedar St., New York 6, N. Y.

JONES BARRIER TERMINAL STRIPS



2-142



2-142-3/4 W

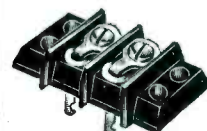

2-142-Y

Bakelite Barriers placed between Terminals increase the leakage path and prevent direct shorts from frayed wires at Terminals. Terminals and screws are of nickel plated brass. Insulation is of BM 120 molded Bakelite.

Illustrated are three types: Screw Terminals, Screw and solder Terminals and Screw Terminal above panel with solder Terminal below. For every need.

Six series cover every requirement: No. 140 — 5-40

screws, No. 141—6-32 screws, No. 142—8-32 screws, No. 150—10-32 screws, 151—12-32 screws and No. 152—1/4-28 screws.

These sturdy Terminal Strips will not only improve your electrical connections but will add considerably to the appearance of your equipment. A truly modern Terminal.

Write today for catalog No. 14 listing our complete line of Barrier Strips in addition to other Electrical Connecting Devices.

HOWARD B. JONES COMPANY
2460 W. GEORGE ST. CHICAGO 18

THE NEW POST WAR PORTABLE

ELECTRIC *Megaphone**

will be available soon for Ships—Towboats—Piers and all marine applications. Also Fire and Police Departments—Athletic Games—and other uses too numerous to mention.

This Megaphone gives your voice 2500 times its normal power.

This equipment is a development of a megaphone used exclusively by U. S. Navy and Amphibious Forces and was developed, manufactured and patented by us.

— WATCH FOR ANNOUNCEMENT —



GUIDED RADIO CORPORATION

161 Sixth Avenue

New York 13, N. Y.

* Patent No. 2,301,459—After the war any infringement of this patent will be prosecuted.

● INSTRUMENT HOUSINGS

● PANELS

● CHASSIS

● STAMPINGS

● SCREW MACHINE PARTS

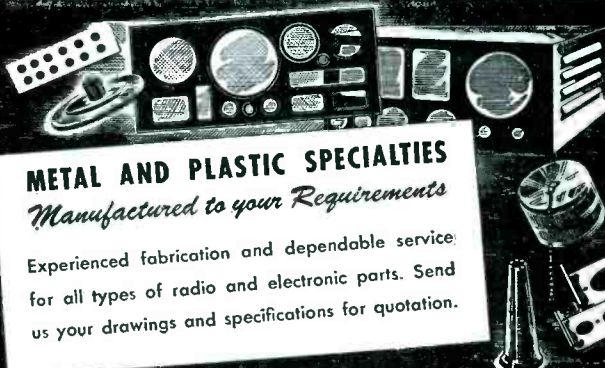

METAL AND PLASTIC SPECIALTIES
Manufactured to your Requirements

Experienced fabrication and dependable service for all types of radio and electronic parts. Send us your drawings and specifications for quotation.

STAMFORD METAL SPECIALTY CO., 428 BROADWAY, N. Y. 13

Metal Work of Every Description

WHAT MAKES A MAILING CLICK?



Mc GRAW-HILL
DIRECT MAIL LIST SERVICE

Advertising men agree . . . the list is more than half the story. McGraw-Hill Mailing Lists, used by leading manufacturers and industrial service organizations, direct your advertising and sales promotional efforts to key purchasing power.

In view of present day difficulties in maintaining your own mailing lists, this efficient personalized service is particularly important in securing the comprehensive market coverage you need and want. Investigate today.

McGraw-Hill Publishing Co., Inc.

DIRECT MAIL DIVISION

330 West 42nd Street

New York, 18, New York

PROFESSIONAL SERVICES

INDUSTRIAL ENGINEERING SPECIALISTS

Engineering Research & Development
 Product Design Market Research
 Sales Brochures Technical Manuals
 Field Surveys Laboratory Analysis
 Complete Engineering Service For All Industries
ASSOCIATED ELECTRONICS COMPANY
 132 Nassau Street, New York 7, N. Y.

J. L. A. McLAUGHLIN

Designer of
Communications Receivers
 Specializing in the elimination of heterodyne interference.
 P. O. Box 529, La Jolla, Calif.

MICHAEL BOZOIAN

Consulting Service In Electronics
 Instrumentation & Controls Design—Development—Models Literature & Patent Surveys
 Recommendations For New Laboratories.
 Telephone 8521
 702 Fifth Street Ann Arbor, Mich.

NATIONAL DESIGN SERVICE

Designers and Developers of
FACTORY TEST EQUIPMENT,
TELEVISION R.F. SWEEP GENERATORS
F.M. SIGNAL GENERATORS
COMPLETE CENTRALIZED MODULATED SYSTEMS
 96 Liberty St. New York 6, N. Y.

COOPER & FLEMING

Consulting Electronic Engineers.
 AM & FM Broadcasting,
 Industrial & Medical Electronics
 420 Market St. Sutter 8854 San Francisco, Calif.

ALBERT PREISMAN

Consulting Engineer
 Specializing in Television and Pulse Techniques, Video Amplifiers, Industrial Applications.
 616 St. Andrews Lane, Silver Spring, Md.

E. STUART DAVIS

Consulting Engineer
Research—Design—Development
 Radio - Carrier Current - Supersonics - Radiant Energy - Control and Measurement - Methods and Devices, Communication - Transportation & Industrial applications.
 Marine Laboratory facilities aboard the yacht "ELECTRON"
 122 N. E. River Drive Ft. Lauderdale, Florida

JOSEPH RAZEK, Ph.D.

Consulting Physicist
 Electrical and Mechanical Engineering Problems
 Instruments and Control Devices Electronics
 Specialists in Colorimetry, Spectrophotometry and Industrial Color Control
 Laboratory and Shop Facilities
 202 Darby Road Lanerch, Pa.
 Phone Hilltop 6916

ELECTRONIC RESEARCH ASSOCIATES

ERA will apply progressive, war-proven developments in electronic research . . . counting . . . timing . . . measuring . . . industrial controls . . . to your manufacturing advantage.
 Box 333, 305 Linden Av., So. San Francisco, Cal.

STANLEY D. EILENBERGER

Consulting Engineer
INDUSTRIAL ELECTRONICS
Design—Development—Models
Complete Laboratory and Shop Facilities
 6309-13—27th Ave.
 Kenosha, Wis. Telephone 2-4213

ELM LABORATORIES

Research and Design
RADIO TRANSMITTERS AND RECEIVERS
 Designs for Home Radios, Electro-Mechanical Devices and Components.
 20 South Broadway Dobbs Ferry, New York
 Phone—Dobbs Ferry 4058

ELECTRONIC ENGINEERS

Designers and Consultants
 Radio and Electronic Product Design
 Radio Equipment to Order
 Industrial Electronic Devices to Order
 Broadcast Station Allocation
 Complete Research and Constructional Facilities
 Phone Citrus 1-6884
 611 E. Garfield Ave. Glendale 5, California

HODGSON & ASSOCIATES

Physics, Mathematics, Research, Development & Patent Consultants.
 Satisfaction guaranteed. Submit your problem for a preliminary survey without cost.
 Box 874 Sherman Oaks, California

DON FOSTER

Engineering Consultant
 Electrical Specialists In Mechanical
 Analysis Sound and Electronics Development
 30 Burns Ave., Wyoming 15, Ohio

SEYMOUR C. HYMAN, Chem. Eng.

Consultant for Industry on
MOISTURE AND FUNGUS PROBLEMS
 For the duration of the war, Chief of Moisture and Fungus Proofing Section developing and applying tropic-proof materials for U. S. Army communications equipment. Now available to manufacturers and materials suppliers for consultation on protective coatings, insulation and choice of engineering materials.
 P. O. BOX 111 Long Branch, N. J.

PAUL E. GERST & CO.

CONSULTING ENGINEERS
 Specialists in
Electrical Product Design
 El. Machinery, Apparatus & Applications
 El. Appliances, Hi-Frequency Apparatus
 Electronics, Radio Communication
 205 W. Wacker Dr. Chicago 6, Ill.

mined by the bandwidth of the filter. "You can't get 20-kc audio signals out of a radio having an i-f bandwidth of 4 kc" is another way of saying the same thing. A band-pass filter having a bandwidth of about one-quarter cycle would require 8 to 10 seconds for the output to build up to a value approximating the final steady-state value if a suddenly changed voltage were applied to the input.

This means that if the picture at the transmitter were suddenly changed, the receiver would require 8 to 10 seconds to remove the old picture and reproduce the new one. In order to transmit a new picture each one-thirtieth of a second, the band-pass associated with each picture element would have to be approximately 60 cycles wide. Actually, according to present day practices, a bandwidth of 30 cycles would be sufficient. This would still require a total spectrum about 7 mc wide, or about the order of magnitude of present day practice.

The system described by Mr. Craig might be fine for a Hollywood clinch with a long fadeout at the end, but I'd hate to watch a boxing match or baseball game on it.

WM. H. UNGER
 Philharmonic Radio Corp.
 New York, N. Y.

[The motion is still before the house that the following statement be called the Hartley Law: "The total amount of information which can be transmitted over a system whose transmission is limited to frequencies lying in a restricted range is proportional to the product of the frequency-range which it transmits by the time during which it is available for transmission." Any further comments?—Ed]

INSTRUMENT FLYING



Wave Jean Gaum gives directions to a Naval officer shut in the Link trainer in the background

CONTACTS

FOR THE FIELD OF ELECTRONICS

Strip Insulated Wires
QUICKER... BETTER

with "Speedex"
AUTOMATIC WIRE STRIPPER
... Speeds Production
Strips insulation from all types of wire — Instantly, easily, perfectly. Just press the handles and the job is done. Cuts wire too. Strips 800 to 1000 wires per hour. Available for all size solid or stranded wires — No. 8 to No. 30. List Price \$6.00.
Write Dept. E for Full Particulars



GENERAL CEMENT MFG. CO.
Rockford, Illinois, U.S.A.

MORE RF KILOWATT HOURS
PER DOLLAR WITH

F & O
TRANSMITTING TUBES

Inquiries Invited—Let us explain how Savings are effected and the F & O greater guarantee.

FREELAND & OLSCHNER PRODUCTS Inc.

611 Baronne St., New Orleans 13, La.

Raymond 4756

High Power Tube Specialists Exclusively
(5 KW To 100 KW)



REX
RHEOSTATS

REX RHEOSTAT COMPANY, BALDWIN, L. I. N. Y.

PROTECTED & UNPROTECTED

RHEOSTATS

WITH LUBRICATED CONTACTS

ROTARY DRIVE RHEOSTATS

WITHOUT BACK LASH

PROTECTED & UNPROTECTED

ADJUSTABLE RESISTORS

UP TO 1000 WATT

PROMPT SHIPMENTS

We manufacture a complete line of equipment

SPOT WELDERS, electric from ¼ to 50KVA
TRANSFORMERS, special and standard types
FLUORESCENT LAMP manufacturing equipment
FLUORESCENT TUBE MAKING EQUIPMENT
ELECTRONIC EQUIPMENT, vacuum pumps, etc.
WET GLASS SLICING and cutting machines for laboratory use
GENERAL GLASS working machines and burners
COLLEGE GLASS working units for students and laboratory
EISLER ENGINEERING CO.

731 So. 13th St. (near Avon Ave.)

AC ARC
WELDERS
from 100 to
400 Amps

Newark, New Jersey



FINE RIBBONS

OF

TUNGSTEN and MOLYBDENUM

Quality and accuracy in our fabrication of Tungsten & Molybdenum Ribbons have characterized our service to the Electronic industry.

A development of

H. CROSS CO.

15 Beekman St., New York 7, N.Y.

Electron Tube Machinery

of every type,—standard, and special design

Specialists in Equipment for the manufacture of Radio Tubes, Cathode Ray Tubes, Fluorescent Lamps, Incandescent Lamps, Neon Tubes, Photo Cells, X-ray Tubes and other glass or electronic products, on production or laboratory basis.

Kahle

ENGINEERING COMPANY

1307-1309 Seventh St., North Bergen, N. J.

MICROMETER
FREQUENCY
METER

for checking
Transmitters
from 1.5 to 56 mc.,
within 0.01 per cent

LAMPKIN LABORATORIES

Bradenton, Fla., U. S. A.

BRAZILIAN

QUARTZ CRYSTALS

CRYSTAL TRADING COMPANY

Importers

118 Liberty St.

New York 6, N. Y.

HETERODYNE ELIMINATORS

If you are troubled by heterodyne interference consult

J. L. A. McLaughlin

P. O. Box 529,

La Jolla, Calif.

Make it a **HABIT** . . . to check this page—**EACH ISSUE**

THIS WHERE TO BUY SECTION supplements other advertising in this issue with these additional announcements of products and services essential to efficient and economical operation in the field of

ELECTRONICS.

Burned Out or Broken Electric Heating Elements



repaired with **NICHRO-CITE PASTE**. Simply overlap ends, apply paste, turn on current. Used by utility companies, etc. Family size, \$1.00, 4 oz. size \$2.50. Satisfaction guaranteed.

Armstrong Mfg. Co., Box 861G Minneapolis, Minn.

MINIATURE PRECISION BALL BEARINGS

(WORLD'S SMALLEST BALL BEARING)

For precision instruments, industrial laboratory equipment, radio and electronic devices, to minimize friction, space, weight and overcome starting torque. Radial and Pivot types.

ENLARGED SIX DIAM.



Radial Series (5 Sizes)
1/8" to 5/16" O. D.

Pivot Series (6 Sizes)
2 mm to 10 mm O. D.

Write for data sheet and catalog E

MINIATURE Precision BEARINGS

KEENE, NEW HAMPSHIRE, U. S. A.

FREE
TO
RADIO MEN

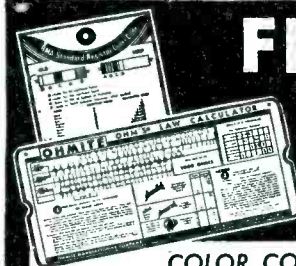

COLOR CODE and OHMS LAW CALCULATOR

Burstein-Applebee of Kansas City offers you this great convenience **FREE**. Easy to work. Solves many problems in a jiffy. **FREE** to radio men, electronic engineers and others in the business. Attach coupon to your letterhead.

MAIL COUPON NOW



BURSTEIN-APPLEBEE CO.
1012 McGEE, KANSAS CITY 6, MO.

Send me **FREE** Color Code and Ohms Law Calculator along with latest catalog.

I am _____
STATE CONNECTION IN INDUSTRY
NAME: _____
ADDRESS _____
TOWN _____ STATE _____

SEARCHLIGHT SECTION

EMPLOYMENT • BUSINESS • OPPORTUNITIES • EQUIPMENT—USED or RESALE

UNDISPLAYED RATE:

15 cents a word, minimum charge \$3.00.
(See § on Box Numbers.)

POSITIONS WANTED (full or part-time salaried individual employment only), 1/2 above rates.

PROPOSALS, 50 cents a line an insertion.

INFORMATION:

BOX NUMBERS in care of any of our New York, Chicago or San Francisco offices count 10 words additional in undisplayed ads.

DISCOUNT of 10% if full payment is made in advance for four consecutive insertions of undisplayed ads (not including proposals).

DISPLAYED—RATE PER INCH:

The advertising rate is \$7.50 per inch for all advertising appearing on other than a contract basis. Contract rates quoted on request.

AN ADVERTISING INCH is measured 7/8 inch vertically on one column, 3 columns—30 inches—to a page.

NEW ADVERTISEMENTS received by 10 A. M. December 7th will appear in the January issue, subject to limitation of space available.

POSITIONS VACANT

(Additional Positions Vacant ads on pages 405 and 421)

WANTED: ENGINEERS with experience in Audio Circuit work for engineering development on hearing aids and associated devices. Experience on hearing aids not actually necessary. Apply to Chief Engineer Zenith Radio Corporation, 6001 W. Dickens Avenue, Chicago 39, Illinois, giving details of education, age and experience. These positions offer excellent opportunities for interested personnel.

WANTED: CAPABLE engineer in radio, television and tube design. Must be able to work in own home or shop. P-953, Electronics, 68 Post Street, San Francisco 4, Cal.

EMPLOYMENT SERVICE

SALARIED POSITIONS \$2,500-\$25,000. Reconversion is creating lifetime opportunities now. This thoroughly organized confidential service of 35 years' recognized standing and reputation carries on preliminary negotiations for supervisory, technical and executive positions of the calibre indicated, through a procedure individualized to each client's requirements. Retaining fee protected by refund provision. Identity covered and present position protected. Send only name and address for details. R. W. Fixby, Inc., 278 Delward Bldg., Buffalo 2, N. Y.

POSITIONS WANTED

RADIO ENGINEER. Interested in V.H.F. development, particularly multi-channel telegraph operation over V.H.F. radio links. (see page 237 August Electronics.) Recently returned from 3 years in charge of V.H.F. development section of British Admiralty. Desires position with company who might be interested in developing new ideas for V.H.F. communication. PW-936, Electronics, 68 Post Street, San Francisco 4, Cal.

ELECTRICAL ENGINEER: 6 years experience desires position in South in design and production small electric or electronic equipment possibly leading toward sales work. PW-954, Electronics, 330 W. 42nd St., New York 18, N. Y.

PHYSICIST, NOW head of research in large concern, desires responsible position as technical director in any research or manufacturing establishment. Age below forty. PW-955, Electronics, 330 W. 42nd St., New York 18, N. Y.

ELECTRONICS ENGINEER: M.A. in Physics, six years experience in the development and design of test equipment for radio and electronics manufacturers desires permanent position in electronic development in New England. PW-956, Electronics, 330 W. 42nd St., New York 18, N. Y.

E.E. COLLEGE graduate now employed in electronic industry desires permanent West-Coast position. Five years varied experience in circuit development, organization, and public contact. Excellent references and records available. \$5,000. PW-957, Electronics, 330 W. 42nd St., New York 18, N. Y.

ELECTRICAL ENGINEER

Graduate, age 35 with 12 years experience, seeks position as Quality Control Manager or Chief Engineer, electrical and radio fields. Past 5 years executive and production experience directing inspection organization of 600 employees for company producing aircraft accessory equipment. (Small motors, electrical controls, radio). Previous experience design, development with leading radio manufacturers.

PW-949, Electronics
520 North Michigan Ave., Chicago 11, Ill.

Curt E. Patton Personnel Engineers

53 W. Jackson Blvd. Chicago 4

offer industry a confidential Personnel Service, selecting and presenting men for positions open—on either a fee or retainer basis.

Outstanding men in electronic and allied fields, with legitimate reasons for seeking a change, are invited to file applications at NO CHARGE, in confidence, so we may present their qualifications to our clients.

WANTED

PHYSICISTS AND ENGINEERS

Unusual opportunities are offered to technical men in advanced fields of exploration, geophysics, applied physics and industrial electronics who wish, to live in a town of 20,000 and maintain a stimulating contact with associates of widely diverse technical skills.

Excellent laboratory facilities including equipment for electron microscopy, x-ray diffraction, mass and optical spectroscopy are available to a small but expanding group.

Opportunities are offered to physicists and engineers of imagination to gain wide recognition for their contributions to the solution of advanced problems.

PHILLIPS PETROLEUM COMPANY
RESEARCH DEPARTMENT
BARTLESVILLE, OKLAHOMA

LOUDSPEAKER DESIGN ENGINEER AND PRODUCTION MAN

Excellent present and future opportunity for the qualified men. Profit sharing and participation in company stock. Must have proved performance and dependability; good judgment plus know-how for straight line economical production. Our organization knows of this ad. Your fully detailed answer held in strict confidence.

P-947, (Agency) Electronics
330 West 42nd St., New York 18, N. Y.

POSITIONS WANTED

ENGINEER, INDUSTRIAL or low-frequency electronics, wants permanent position commuting distance New Canaan, Conn. Some experience production, development, laboratory, but most satisfactory in sales, technical writing. Prefers work involving people more than things. Johnson O'Connor tested; results available to prospective employer. Reason for availability—present employer closing New York branch. J. B. Campbell, P.O. Box 834, New Canaan, Conn.

MAN INHERENTLY Lazy, no college graduate, no correspondence schooling, but 20 years in U. of H.K. (University of Hard Knocks), in installation, maintenance service and troubleshooting on wiring, motors and generators, radio and radar. Anything in electronics considered (particularly industrial electronic control equipment) where I stand around and watch the other fellow work. More money and less work desirable. Midwest location. Present salary \$6,000 per year. Available within the next 60 or 90 days. Give complete details in first letter. PW-958, Electronics, 330 W. 42nd St., New York 18, N. Y.

RADIO ENGINEER, M.S., E.E. degrees, experience in practical design and development, desires to join manufacturers of electronic instruments, transmitters, receivers, heating, tubes, or parts as sales engineer and technical representative in China, many years radio business experience in China. PW-959, Electronics, 330 W. 42nd St., New York 18, N. Y.

(Continued on page 422)

Industrial designers!

Do you want to join a company which is out to give the buying public of the present and future the very best in product appearance? If you do, General Electric has a career job for you. The wide range of G-E products for the home offers fertile ground for imaginative, diversified designing. Industrial Designers on our payroll will therefore have an unprecedented opportunity to employ their talents in the creation of designs for G-E electrical appliances and apparatus and radio cabinets. Write now, giving your qualifications, to Mr. M. B. Tracy, Appliance & Merchandise Department, General Electric Co., Bridgeport, Conn.

ELECTRONIC ENGINEER

As research and design engineer with vacuum tube hearing aid company. Must be graduate E.E. Some electronic and acoustical experience desired. Unusual opportunity to progress with aggressive company. Compensation secondary to provable ability. Permanent position. Describe education, experience, aptitudes and age. State salary desired. Apply in complete confidence.

P-873, Electronics
330 West 42nd St., New York 18, N. Y.

for CAMERAS and PROJECTORS

Highly rated firm in the East manufacturing established line of amateur photographic equipment is interested in securing executive engineers or designers now commanding good salaries in camera goods or kindred type of work. Consideration given to original letters giving complete necessary details including home phone number, names of present or former employer, etc.

P-963, Electronics
330 West 42nd Street, New York 18, N. Y.

ENGINEER HIGH QUALITY RADIO RECEIVERS

We need a high grade engineer who is thoroughly familiar with the design and production of radio receivers and has had several years experience. Knowledge of power and audio transformers also highly desirable. Small company located close to New York.

P. O. Box 430
Elizabeth, N. J.
or Elizabeth 2-1735

(Additional Positions Wanted & Selling Opportunity Advertising on Page 422)



WANTED

SENIOR DEVELOPMENT ENGINEER

Large Midwest manufacturer has immediate openings in domestic radio and television receiver development for two Senior Radio Project Engineers and one Mechanical Engineer. Confidential inquiries respected.

P-813, Electronics
520 North Michigan Ave., Chicago 11, Ill.

WANTED

Assistant Chief Engineer

Midwest radio manufacturer requires an engineer to assume complete supervision of household and auto radio receiver development. Extensive prewar experience in above lines imperative. Television receivers will be in our line. All inquiries confidential.

P-814, Electronics
520 North Michigan Ave., Chicago 11, Ill.

Radio Engineers Wanted

for design and development of home radio receivers.

Can use men with exp. in design laboratories on communications and entertainment receiving sets. CALL OR WRITE

Mr. Frank A. Hinners
Vice pres: Chge. of Engineering

Air King Products

1523 63rd St., Bklyn 19, N. Y.

Permanent Employment ELECTRONIC DEVELOPMENT ENGINEERS

Well-established Eastern Massachusetts concern desires graduate electronic engineers with flair for research and eye to future. Permanent position concerned at present with important development work for government with increased opportunities after the war. Unusual openings for men with capacity and initiative. Must be U. S. Citizens.

P-670, Electronics
330 West 42nd St., New York 18, N. Y.

WANTED

RESEARCH ENGINEERS

Prominent Radio Receiver Manufacturer located in Midwest has immediate openings for two research men with prewar development experience in the radio receiver or television field. Confidential inquiries respected.

P-815, Electronics
520 North Michigan Ave., Chicago 11, Ill.

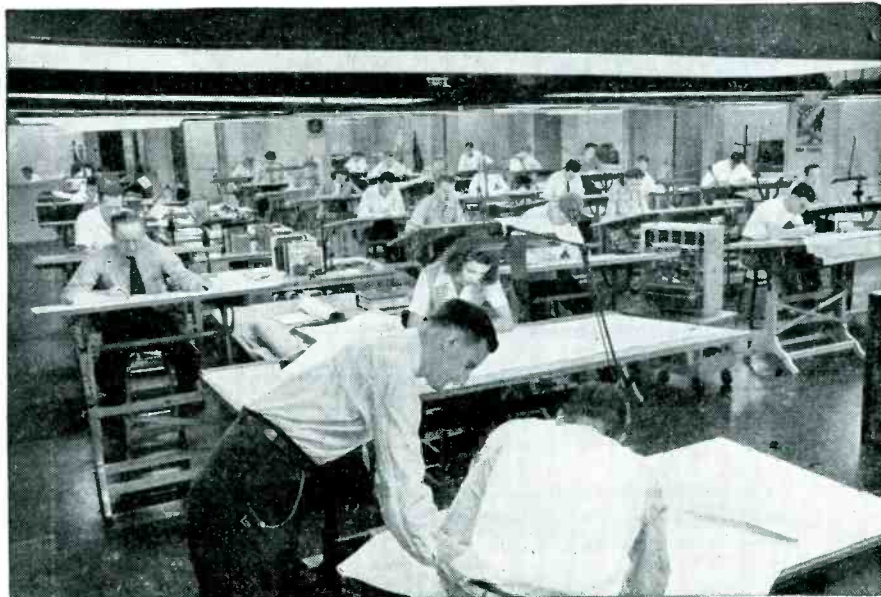

Experienced Mechanical Drafting Design Engineers, Design Draftsmen, Junior and Senior Draftsmen

The Collins Radio Company has always been a pioneering organization—an *engineer's* engineering and manufacturing outfit.

It was the pioneering urge that led us to introduce professional standards of design and performance in transmitters and receivers for radio hams in the early thirties . . .

To plan and build special radio equipment that stood up to the rough-and-tumble of Admiral Richard E. Byrd's second expedition to Little America . . .

To take high quality broadcast equipment out of the laboratory and make it economically practicable for any broadcasting station . . .

To meet the individual requirements of some of the great airlines with specially engineered communication equipment, including the ingenious Collins Autotune.

To be prepared on December 7, 1941, to go into production of airborne and ground based radio gear of highly advanced design for the Armed Forces—the result of research and development looking years ahead.

We are looking far ahead today in the field of high quality radio communication equipment. Our post-war plans, well advanced, offer a very substantial opportunity for additional

junior and senior draftsmen with at least three to five years of practical mechanical drafting, design, draftsmen with at least five years of experience in design drafting, and mechanical drafting design engineers with eight to ten years of mechanical design experience. Our work involves the production of small, intricate mechanical and electrical mechanisms.

This is a splendid opening for men and women who are able to make neat, accurate parts drawings with complete specifications, assembly drawings and layouts, who will assume responsibility, and who have knowledge of general standard shop and field practices. Cedar Rapids is a human, wholesome city of about 65,000. People enjoy living here. And people enjoy working, without being distracted by weather variations, in the modern controlled-conditions Collins plant.

If you feel that you could fit happily and capably into this organization, write us fully. Tell us about your education, experience, age, desired compensation and draft status. W.M.C. regulations, of course, must apply.

Address E. H. Reinschmidt,
Superintendent of Design,
Collins Radio Company,
Cedar Rapids, Iowa.



Efficient Manufacturing Facilities Available

for sub-contracting

- ★ Sub-assembly and Complete Assembly Operations
- ★ Automatic - Screw Machines
- ★ Drilling, Tapping and Centerless Grinding
- ★ Electro-Plating

Facilities of three "E" Award manufacturing plants - conveniently located to insure "on schedule" production at the lowest costs - expert engineering service accustomed to precision manufacturing.

Company Representative will call to Discuss Details

John R. Wald Company

PHONE 682
HUNTINGDON, PENNSYLVANIA

POSITIONS WANTED (Continued from page 420)

TRANSFORMER ENGINEER: long experience design, production radio—luminiscent tube and specialty transformers. Exp. design setup mass production equipment. PW-960, Electronics, 330 W. 42nd St., New York 18, N. Y.

ELECTRONIC ENG. 15 years experience in Europe, 3 years in U. S. manufacturing vac. cathode ray tubes etc. Exhaust, emission and glass working problems wants position as first assistant to chief eng. or technical adviser. PW-961, Electronics, 330 W. 42nd St., New York 18, N. Y.

SELLING OPPORTUNITY WANTED

ELECTRONIC ENGINEER: 14 years experience as executive research and installation. Maintenance engineer of airborne and ground equipment. Desire sales representation or installation and maintenance engineering position. Prefer Central or South America. Speaks Spanish fluently. SA-962, Electronics, 330 W. 42nd St., New York 18, N. Y.

Established electronic representative sales agency has OPENING FOR A FIELD MAN

For Connecticut, Western Massachusetts and Vermont. Knowledge of and experience with radio-electronic parts helpful. A position with a future under contract for the qualified man.

RW-948, (Agency) Electronics
330 West 42nd St., New York 18, N. Y.

TECHNICAL SALES ENGINEER

Experienced in electronics, or preferably electronic physics. Permanent position and good opportunity for man who has technical qualifications and ability to establish firm lasting inter-company contacts. Salary open. In replying give full details of your experience.

SW-950, Electronics
520 North Michigan Ave., Chicago 11, Ill.

SALES REPRESENTATION WEST COAST

If you are a manufacturer of electrical or electronic equipment for industrial applications, let our staff of experienced engineering consultants represent your products on the west coast. Address

RA-934, Electronics
68 Post St., San Francisco 4, Calif.

RADIO and TELEVISION

Leading Danish manufacturer of radio sets and parts: wants connection with American manufacturers in the Radio, P.M., Television and Electrical Music industry, who would be interested in cooperating to exploit present potentialities of Denmark market.

A/S Rasmus Rudholt
Howitzvej 11—Copenhagen F.
Denmark

MERKURIANA

is our cable address. Wholesale Dealers and large industry consumers are our clients. We act as Manufacturers' Agent on your behalf against a small commission. Open to offers on all Electronic products.

TEKNO - MERKUR
Industrial Agencies
Postbox 617 Stockholm I. Sweden

FOR SALE

Controlling Stock Interest

in well known transformer manufacture. Excellent opportunity to enter this active business

BO-876, Electronics
330 West 42nd St., New York 18, N. Y.

FOR SALE

PAPER CONDENSER PLANT

Machinery, equipment and materials for manufacturing paper condensers. This is an opportunity for an experienced condenser man to start in business with limited capital.

BO-964, Electronics
520 North Michigan Ave., Chicago 11, Ill.

NAVAL OFFICER

Released from active duty desires to purchase interest in currently operating or proposed AM and/or FM Radio Station. Will also consider Mfg. or Distribution of Electronic Equipment.

BO-952, Electronics
330 West 42nd Street, New York 18, N. Y.

REPRESENTATION IN TURKEY

A well known Turkish radio company desires to represent American manufacturers of transmitters, receivers, sound systems, recorders, test and measuring equipment, dynamotors, converters and other electronic products. Write details to:

Mors Telsiz Atelyesi
Sisli P. K. 66

Istanbul Turkey

NATIONAL DISTRIBUTION AVAILABLE

For Manufacturers who make products suitable for sale to radio and electronic jobbers. We have a complete sales staff for national and export distribution. Reply with samples or description of products.

RA-870, Electronics
330 West 42nd St., New York 18, N. Y.

SALES REPRESENTATION EAST COAST

A group of experienced engineering consultants desire to represent manufacturers of Radio & Electronic products. Please reply with description of products.

RA-951, Electronics
330 West 42nd Street, New York 18, N. Y.

BEST QUALITY, USED

ELECTRON TUBE MACHINERY

Equipment for the manufacture of all kinds of electron tubes, radio tubes, incandescent lamps, neon tubes, photo electric cells, X-ray tubes, etc.

AMERICAN ELECTRICAL SALES CO., INC.
65-67 East 8th St. New York, N. Y.

WANTED

Your Business

"ANYTHING containing IRON or STEEL"

MORE FOR YOUR DOLLAR
IRON & STEEL PRODUCTS, INC.

40 years' experience
13422-A S. Brainard Ave., Chicago 33, Ill.



Export for Profit

Roburn Agencies, Inc. have represented leading manufacturers of radio and electrical equipment, parts and accessories, in world-wide markets since 1935. Extensive facilities relieve you of all export headaches - correspondence, advertising, sales, finance, packing and shipping. A few additional clients seeking experienced, reliable representation are invited. Write for information on Profits Through Exports.



Roburn Agencies, Inc.

115E Fulton Street New York 7, N. Y.

WRITE FOR 24 P. CATALOG OF

METERS

AND INSTRUMENTS

- | | |
|--------------|----------------------|
| VOLTMETERS | BRIDGES (Wheatstone) |
| AMMETERS | MEG OHMMETERS |
| MICRO | RHEOSTATS |
| AMMETERS | VARIABLE |
| OHMMETERS | TRANSFORMERS |
| FREQ. METERS | RELAYS |

ELECTRO-TECH Equipment Co.

329 CANAL ST., N. Y. 13, N. Y.

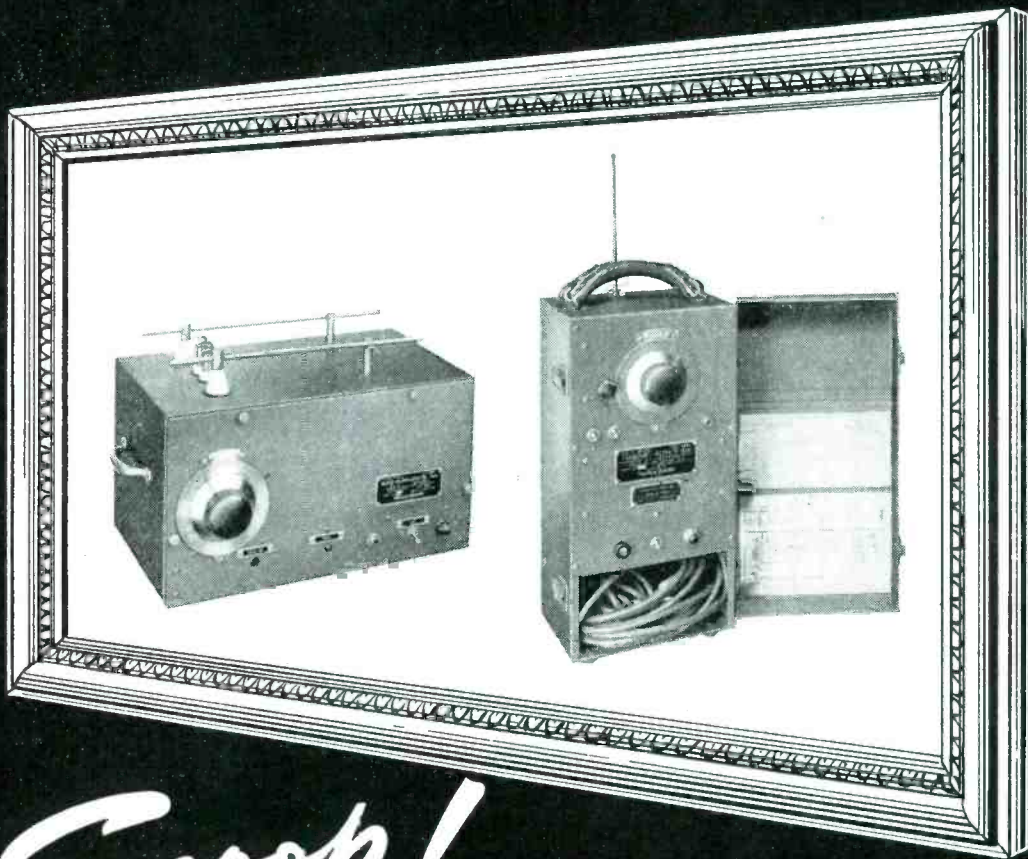

Scoop!

Left: Radio Modulator BC-423. High frequency signal generator operating from 195 to 205 mc., modulated at approximately 5000 cycles. Ruggedly built in steel case. Designed so that it can be re-adapted to many applications. Can be used as high frequency receiver, transceiver or frequency meter. Good for lab demonstrations requiring low power, ultra high frequency generator. Can be converted to 2½ or 1¼ meter receiver.

Right: Frequency Meter BC-438. Ultra-high frequency signal generator operating from 195 to 205 mc. with crystal calibration. Aluminum chassis in steel case. Removable nickel plated 19" telescopic antenna. Use as high frequency receiver or transmitter. Can be converted to cover any frequency range. Takes dry batteries for portable use. Precision tuning control make it ideal for "on the nose" ECO transmitter control unit.

hallicrafters RADIO

THE HALLICTRAFTERS CO., AGENT FOR RFC UNDER CONTRACT SIA-3-24
MANUFACTURERS OF RADIO AND ELECTRONIC EQUIPMENT

THESE VALUABLE ITEMS *Available Now*
or very soon. Write, wire or phone for further information • head phones • test equipment • component parts • marine transmitters and receivers • code practice equipment • sound detecting equipment • vehicular operation police and command sets • radio beacons and airborne landing equipment.

CLIP THIS COUPON NOW

RFC DEPARTMENT 417 HALLICTRAFTERS
5025 West 65th Street • Chicago 38, Illinois
 Send further details on merchandise described above
 Send listings of other available items
Especially interested in _____
STATE _____
NAME _____
CITY _____ ZONE _____
ADDRESS _____



Now - MATCH THEIR BEST WITH YOUR MOST IN THE VICTORY LOAN!

Top off your good work on your Payroll Savings Plan with an outstanding showing in the Victory Loan—our last all-out effort!

Help bring our boys back to the homes for which they

fought—and give our wounded heroes the best of medical care—by backing the Victory Loan! You know your quota! You also know by past war-loan experience that your personal effort and plant solicitation are required to make your quota.



Sell the New F.D. Roosevelt Memorial \$200 Bond through your PAYROLL SAVINGS PLAN!

In rallies, interdepartmental contests, and solicitations, promote the new Franklin Delano Roosevelt Memorial \$200 Bond! Better than "cash in hand," Victory Bonds enable the buyers to build for the future—assure a needed nest egg for old age.

Keep on giving YOUR MOST to the Victory Loan! All Bond payroll deductions during November and De-

cember will be credited to your quota. Every Victory Bond is a "Thank You" to our battle-weary men overseas—also a definite aid in making their dreams of home come true! Get behind the Victory Loan to promote peacetime prosperity for our returning veterans, your nation, your employees—and your own industry!

The Treasury Department acknowledges with appreciation the publication of this message by



ELECTRONICS

An official U. S. Treasury advertisement prepared under auspices of Treasury Department and War Advertising Council

December 1945 — ELECTRONICS

INDEX TO ADVERTISERS

	Page		Page
Acheson Colloids Corporation	197	Connecticut Telephone & Electric Division	311
Acro Electric Co.	304	of G. A. I.	273
Aerovox Corporation	38	Consolidated Molded Products Corporation	375
Agaloy Tubing Company	251	Continental-Diamond Fibre Co.	178
Air Reduction	407	Cook Electric Co.	87
Aircraft-Marine Products, Inc.	257	Cornell-Dubilier Electric Corp.	62
Aireon Manufacturing Corp.	211	Corning Glass Works	411
Alden Products Company	396	Cornish Wire Company, Inc.	220
Allegheny Ludlum Steel Co.	183	Coto-Coil Co., Inc.	387
Allied Control Co., Inc.	53	Croname, Inc.	419
Allied Radio Corp.	402	Cross, H.	288
Allis-Chalmers, Electronic Devices Section B,	9	Crystal Research Laboratories, Inc.	419
Altec Lansing Corporation	320	Crystal Trading Co.	419
Aluminum Company of America	219		
Amalgamated Radio Television Corp.	200		
American Electrical Heater Co.	278		
American Gas & Chemical Co.	413		
American Lava Corporation	19		
American Lens Co., Inc.	68		
American Phenolic Corp.	55, 414		
American Photocopy Equipment Co.	412		
American Platinum Works	310		
American Radio Co.	314		
American Screw Co.	206		
American Time Products, Inc.	174		
American Transformer Co.	275		
Amperex Electronic Corporation	Inside Front Cover		
Amperite Co.	278		
Anaconda Wire & Cable Co.	177		
Andrew Co.	192		
Arkwright Finishing Co.	184		
Armstrong Mfg. Co.	419		
Arnold Engineering Co.	248		
Art Wire & Stamping Co.	409		
Associated Research, Inc.	394		
Astac Corporation	372		
Audak Co.	427		
Audio Development Co.	328		
Audio Devices, Inc.	233		
Auto Engraver Co.	314		
Automatic Electric Sales Corp.	34		
Automatic Mfg. Corporation	74		
Bakelite Corporation	193		
Baker-Phillips Co.	290		
Ballantine Laboratories, Inc.	280, 411		
Barker & Williamson	180		
Belden Manufacturing Co.	227		
Bell Telephone Laboratories	86		
Bendix Aviation Corp., Pacific Div.	199		
Bendix Aviation Corp., Radio Div.	189		
Bentley, Harris Mfg. Co.	203		
Benwood-Linze Co.	258		
Birnback Radio Co., Inc.	415		
Bittermann Electric Co.	411		
Boonton Radio Corp.	332		
Bowser, Inc.	409		
Bradley Laboratories, Inc.	339		
Brand & Co., William	261		
Breeze Corporations, Inc.	317		
Bruning Company, Inc., Charles	215		
Buchmann Spark Wheel Corp.	324		
Bud Radio, Inc.	412		
Burgess Battery Co.	415		
Burlington Instrument Co.	362		
Burdy Engineering Co., Inc.	263		
Burstein-Applebee Co.	419		
Callite Tungsten Corp.	60		
Cambridge Thermionic Corporation	413		
Capacitron Company	334		
Capitol Radio Engineering Institute	406		
Carborundum Company	355		
Cardwell Mfg. Corp., Allen D.	292		
Carter Motor Co.	414		
Celanese Corp. of America	77		
Cellusuede Products, Inc.	403		
Central Paper Co., Inc.	374		
Centralab, Div. of Globe-Union, Inc.	54		
Chace Co., W. M.	360		
Chatham Electronics	41		
Cherry Rivet Company	313		
Chicago Metal Hose Corp.	346		
Chicago Telephone Supply Co.	42		
Chicago Transformer Corp.	395		
Cinaudagraph Corporation	36, 37		
Cinaudagraph Speakers, Div. of Aireon	403		
Cinch Mfg. Corp.	163		
Cinema Engineering Co.	318		
Clare & Co., C. P.	66		
Clarostat Mfg. Co., Inc.	340		
Clippard Instrument Laboratory	376		
Cohn & Co., Sigmund	270		
Collins Radio Co.	80		
Communication Measurements Laboratory	399		
Conant Electrical Laboratories	348		
Concord Radio Corporation	397		
Condenser Products Company	310		
Dalis, Inc., H. L.	282		
Daven Company	Inside Back Cover		
Dayton Rogers Mfg. Co.	405		
De Mornay Budd, Inc.	309		
Deutschrann Corp., Tobe	6		
Dial Light Co. of America, Inc.	392		
Diamond Instrument Co.	69		
Diebel Die & Mfg. Co.	298		
Distillation Products, Inc.	245		
Dixon's Typhonite ELDORADO Pencils	405		
Dongan Electric Mfg. Co.	401		
Dow Chemical Co.	269		
Dow Corning Corporation	277		
Drake Electric Works, Inc.	407		
Drake Manufacturing Co.	384		
Driver-Harris Co.	45		
Dumont Electric Co.	28		
DuMont Laboratories, Inc., Allen B.	22		
Durez Plastics & Chemicals, Inc.	15		
DX Radio Products Co.	262		
Dynamic Air Engineering, Inc.	237		
Dzus Fastener Co., Inc.	221		
Eastern Air Devices, Inc.	247		
Eastern Amplifier Corporation	194		
Eastern Electronics Corp.	47		
Eby, Inc., Hugh H.	290		
Eicor, Inc.	216		
Eisler Engineering Co.	282, 419		
Eitel-McCullough, Inc.	89		
Elastic Srop Nut Corporation of America	67		
Electric Indicator Co.	370		
Electrical Industries, Inc.	407		
Electrical Insulation Co., Inc.	378		
Electrical Reactance Corp.	294		
Electrix Corporation	411		
Electronic Engineering Co.	384		
Electronic Enterprises, Inc.	240		
Electronic Mechanics, Inc.	7		
Electronics Research Publishing Co.	306		
Electrons, Inc.	316		
Engineering Company	306		
Erco Radio Laboratories, Inc.	354		
Ericsson Screw Machine Products Co., Inc.	400		
Erie Resistor Corp.	56		
Essex Electronics	425		
Fairchild Camera & Instrument Corp.	361		
Farnsworth Television & Radio Corp.	289		
Federal Electric Co., Inc.	389		
Federal Tel. & Radio Corp.	175, 305, 405		
Fenwal, Inc.	322		
Ferranti Electric, Inc.	40		
Follinsbee Steel Corporation	212		
Ford Radio & Mica Corp.	392		
Formica Insulation Mfg. Company	207		
Foster Company, A. P.	222		
Franklin Airloop Corporation	179		
Freeland & Olschner Products, Inc.	419		
Gates Radio Company	325		
Gear Specialties	59		
General Cable Corp.	64, 65		
General Cement Mfg. Co.	419		
General Ceramics & Steatite Corp.	291		
General Electric Co.	11, 12, 13, 14, 48, 49, 231, 236, 297, 396, 409		
General Industries Co.	310		
General Instrument Corp.	249		
General Magnetic Corp.	274		
General Plate Div. of Metals & Controls Corp.	337		
General Radio Company	351		
General Tire & Rubber Co.	307		
Gibbs & Company, Thomas B.	238		
Glaser Lead Co., Inc.	366		
Goat Metal Stampings, Inc.	278		
Goodrich Chemical Co., B. F.	432		



Showing our complete manufacturing facilities from raw materials to finished product! ➔

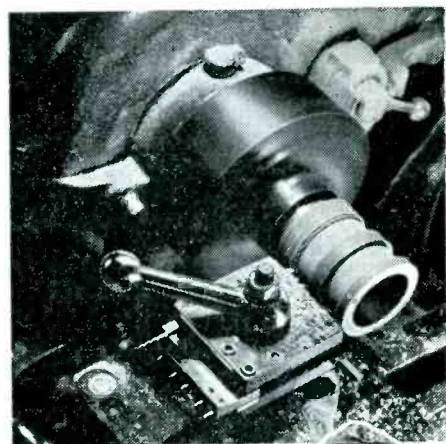

Lathe Facilities for turning coil forms for all types of coils



Production techniques in the Radio industry have reached high degrees of perfection during the war . . . and the same qualities that made Victory possible, are now being translated into peacetime radios that will stand head and shoulders above yesterdays product. Here at ESSEX, all the facilities are available to make precision components for these new, more perfect instruments. Yes . . . ESSEX is ready to serve your most exacting requirements.

Precision manufacturers of all types of IF and RF coils, chokes, and transformers.

ESSEX ELECTRONICS
1060 Broad St., Newark, N. J.

HARRISON HAS RECEIVERS!

110 KC TO 210 MC!

FOR IMMEDIATE DELIVERY

Here's the good news we've all been waiting for. Harrison can ship you **WITHIN 24 HOURS** a brand new, latest improved model Communications Receiver.

110 KC TO 18 MC

HALLICRAFTERS S-22R

Complete \$74.50

550 KC TO 42 MC

HALLICRAFTERS SX-28A

\$223

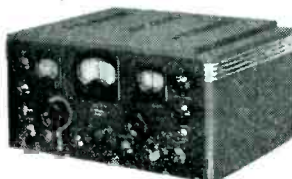

27.8 TO 143 MC

HALLICRAFTER S-36A

\$415



130 TO 210 MC

HALLICRAFTERS S-37

\$591.75

HAMMARLUND SUPER PRO

The world famous standard of dependability. 18 tubes, noise limiter, electrical band-spread, variable IF selectivity, wide range audio system. Designed for 24 hours a day service!

ASP-210-X 540 KC to 20 MC
ASP-210-SX 1250 KC to 40 MC

Either model, complete with power supply and speaker \$318

HAMMARLUND HQ-129-X

The improved version of the well liked HQ-120. Complete with speaker \$129

RME-45

Here's the old, reliable RME-69—refined and brought up-to-the-minute through valuable experience gained in military service. Better than ever! Complete \$166

NATIONAL H R O

Nine tubes, 1.7 to 30 MC Table model, complete with tubes, speaker and pack \$226.35

TRANSCRIPTION AND RECORDING ASSEMBLY

Rek-O-Kit RK-D16. Dual speed, 16" dynamically balanced turn table, constant speed motor, completely assembled on cast iron mounting base \$148.38

RECORD CHANGERS

Webster Model 56. Plays 10" or 12" records. Spindle drop type \$34.50

BRUSH PL-20 CRYSTAL PICK-UP

For transcriptions up to 17/4" dia. With equalizer \$27.00

Literature describing these Receivers is available upon request.

(Prices subject to change without notice)

Have you our new 800 page BUYERS GUIDE? Write today!

INDEX TO ADVERTISERS

Continued

	Page		Page
Gothard Manufacturing Company	378	National Carbon Co., Inc.	385
Gould-Moody Co.	320	National Company, Inc.	335
Gramer Company	314	National Moldite Company	390
Graphite Metallizing Corp.	398	New England Screw Co.	403
Greenlee Tool Co.	310	New Haven Railroad	371
Guardian Electric Mfg. Co.	301	New York Transformer Co.	195
Guided Radio Corporation	417	Newark Electric Co.	393
		Northern Communications Mfg. Co.	415
		Northern Industrial Chemical Co.	394
Hallicrafters Co.	39		
Hammarlund Mfg. Co., Inc.	10	Ohio Electric Mfg. Co.	342
Hanovia Chemical & Manufacturing Co.	260	Ohmite Mfg. Company	331
Hardwick, Hindle, Inc.	401	Oiljak Manufacturing Co., Inc.	226
Harris Products Co.	196	Onan & Sons, D. W.	390
Harrison Radio Corp.	426	O'Neil-Irwin Mfg. Co.	402
Harvey Radio Company	380	Operadio Manufacturing Co.	204
Harvey Radio Laboratories, Inc.	167	Oster Mfg. Co., John	353
Hassall, Inc., John	258	Owens-Corning Fiberglas Corporation	321
Heinemann Circuit Breaker Co.	201		
Heintz & Kaufman, Ltd.	29	Pan-Electronics Laboratories, Inc.	368
Helipot Corporation	285	Par-Metal Products Corporation	404
Hewlett-Packard Company	57	Peerless Electrical Products Co.	208
Hudson American Corporation	386	Peerless Roll Leaf Co., Inc.	302
Hudson Wire Co.	258	Perfection Electric Co.	401
Hunter Pressed Steel Co.	31	Permo, Inc.	266
Hytron Radio & Electronics Corp.	82	Permoflux Corporation	352
		Petersen Radio Co.	290
Ilg Electric Ventilating Co.	394	Phillips Screw Manufacturers	50
Indiana Steel Products Co.	191	Photox Silk Screen Supply Co.	380
Industrial Condenser Corp.	224	Piezo Manufacturing Corp.	274
Industrial Transformer Corp.	287	Pioneer Gen-E-Motor Corp.	272
Insl-X Co., Inc.	338	Plastic Manufacturers, Inc.	242
Instrument Resistors Company	408	Plastic Wire & Cable Corp.	255
Insulation Manufacturers Corp.	51	Potter & Brumfield Mfg. Co., Inc.	408
Insuline Corporation of America	264	Potter Company	415
International Nickel Co., Inc.	214	Premax Products	403
International Resistance Co.	169	Press Wireless, Inc.	253
Irvington Varnish & Insulator Co.	271	Presto Recording Corp.	44
Islip Radio Mfg. Corp.	407	Printloid, Inc.	333
		Progressive Mfg. Co.	294
		Pyroferic Co.	288
Janette Manufacturing Co.	298		
Jelliff Mfg. Corp., C. O.	266	Quadrige Mfg. Co.	415
Jennings Radio Mfg. Co.	190	Quaker City Gear Works, Inc.	344
Jensen Radio Mfg. Co.	63		
Jerome Engineering Co.	383	Radex Corporation	409
Johnson Co., E. F.	303	Radiart Corporation	299
Joliet Chemicals, Ltd.	377	Radio Condenser Co.	79
Jones Co., Howard B.	417	Radio Corp. of America, Victor Div.	16, 32
			181, Back Cover
		Radio Development & Research Corp.	315
Kahle Engineering Co.	419	Radio Engineering Lab's, Inc.	319
Karp Metal Products Co., Inc.	26	Radio Receptor Co., Inc.	369
Ken-Rad Div. of General Electric Co.	250	Radio Supply & Engineering Co., Inc.	388
Kenvon Transformer Co., Inc.	210	Radio Wire Television, Inc.	386
Kester Solder Co.	228	Railway Express Agency, Inc.	262
Keuffel & Esser Co.	3	Rauland Corporation	209
Kold-Hold Manufacturing Co.	409	Rawson Electrical Instrument Co.	409
		Rathenon Mfg. Co.	35, 259
Lampkin Laboratories	410	R-B-M Manufacturing Company	58
Langwin Company, Inc.	63	Reiner Electronics Co.	223
Lapp Insulator Co., Inc.	17	Reliable Spring & Wire Forms Co.	350
Lavoie Laboratories	365	Revere Copper & Brass, Inc.	329
Leach Relay Company	217	Rex Rheostat Co.	419
Leland Electric Co.	359	Rice's Sons, Inc., Bernard	341
Lewis Electronics	295	Richardson Company	276
Lewyt Corporation	327	Ripley Company, The	270
Linde Air Products Co.	306	Robinson Aviation, Inc.	379
Littelfuse, Inc.	213	Rockbestos Products Corp.	281
Lord Manufacturing Co.	230	Rogan Brothers	262
L-R Manufacturing Co.	270	Roller-Smith Co.	187
		Russell Electric Co.	70, 267
Maas & Waldstein Company	182		
Macallen Company	284	Singamo Electric Co.	20, 21
Machlett Laboratories, Inc.	75	Santay Corporation	61
Madison Electrical Products Corp.	312	Schweitzer Paper Co.	279
Mallory & Co., Inc., P. R.	90, 165, 254	Scientific Electric Div. of "S" Corrugated	
Manross & Sons, F. N.	188	Quenched Gap Co.	46
Marion Electrical Instrument Co.	52	Scovill Mfg. Co., Electronic Div.	343
MB Manufacturing Co., Inc.	235, 286	Scovill Mfg. Co., Waterville Screw Products Div.	173
McGraw-Hill Book Co.	413	Screenmakers	282
McLaughlin, J. L. A.	302, 419	Seeburg Corporation, J. P.	230
Measurements Corporation	266	Selenium Corporation of America	298
Metallic Arts Co.	376	Shakeproof, Inc.	84
Micro-Ferrocot Products, Div. of Maguire Industries, Inc.	81	Shallcross Mfg. Co.	376
Millen Mfg. Co., Inc., James	374	Shure Brothers	171
Miniature Precision Bearings	419	Sickles Company, F. W.	30
Mitchell-Rand Insulation Co., Inc.	241	Sigma Instruments, Inc.	356
Monarch Mfg. Co.	410	Signal Indicator Corp.	314
Monsanto Chemical Co., Plastics Div.	205		
Multicore Solders, Ltd.	283		
Mycalex Corporation of America	85		

HARRISON
RADIO CORPORATION
 12 WEST BROADWAY • NEW YORK CITY 7
 BARCLAY 7-9854
 JAMAICA BRANCH — 172-31 Hillside Ave. — REPUBLIC 9-4102

	Page
Sillcocks-Miller Co.	382
Smith Mfg. Co., Inc., F. A.	294
Sola Electric Co.	23
Sorensen & Company, Inc.	381
Sound Equipment Corp. of Calif.	252
Speer Carbon Company	357
Spencer Thermostat Company	367
Spencer Wire Co.	243
Sprague Electric Co.	73
Stackpole Carbon Co.	373
Stamford Metal Specialty Co.	417
Standard Piezo Company	363
Standard Pressed Steel Co.	404
Standard Transformer Corp.	176
Star Expansion Products Co.	417
Star Porcelain Co.	401
Sta-Warm Electric Co.	270
Stedman Machine Works, Robert L.	302
Stephens Manufacturing Co.	256
Sterling Manufacturing Company	202
Stevens-Walden, Inc.	382
Steward Mfg. Co., D. M.	407
Stokes Machine Co., F. J.	274
Struthers-Dunn, Inc.	33
Stupakoff Ceramic & Mfg. Co.	246
Sun Radio & Electronics Co., Inc.	406
Superior Electric Co.	347
Supreme Instruments Corp.	306
Sylvania Electric Products, Inc.	349

Tech Laboratories	286
Telesivo Products Co.	244
Thermador Electrical Mfg. Co.	71
Thomas & Skinner Steel Products Co.	413
Thordarson Electric Mfg., Div. of Maguire Industries, Inc.	27
Tinnerman Products, Inc.	185
Transmitter Equipment Mfg. Co., Inc.	43
Triplett Electrical Instrument Co.	416
Tung-Sol Lamp Works, Inc.	72
Turner Company	336

Ucinite Company	198
Union Carbide & Carbon Corp.	193, 306, 385
United Transformer Corp.	2

Victoreen Instrument Co.	388
Victory Manufacturing Co.	256

Waldes Kohinor, Inc.	293
Walker-Turner Co., Inc.	296
Wallace & Tienan Products, Inc.	18
Waltham Screw Co.	358
Ward Leonard Electric Co.	391
Ward Products Corporation	400
Warren Telechron Co.	323
Waterbury Companies, Inc.	398, 416
Webster Chicago	225
Webster Electric Co.	268
Weller Mfg. Co.	396
Western Electric Co.	24, 25, 88
Westinghouse Electric Corporation	4, 5, 265
Weston Electrical Instrument Corp.	218
Whistler & Sons, Inc., S. B.	229
Whitaker Cable Corp.	76
White Dental Mfg. Co., S. S.	345
Whitehead Stamping Co.	411
Willor Manufacturing Corp.	308
Wilson Co., H. A.	78, 186
Workshop Associates, The	410

Zenith Optical Laboratory	208
Zophar Mills, Inc.	286

PROFESSIONAL SERVICES	418
-----------------------	-----

SEARCHLIGHT SECTION
(Classified Advertising)

BUSINESS OPPORTUNITIES	422
CONTRACT WORK	422
EMPLOYMENT	405, 420, 421, 422
USED EQUIPMENT	422-423
American Electric Sales Co., Inc.	422
Electro-Tech. Equipment Co.	422
Hallicrafters Co.	423
Iron & Steel Products Inc.	422

5

letter-word for PICK-UP PERFORMANCE

Audax

... the substantially unanimous verdict of experts and music lovers who have put the

RELAYED-FLUX Microdyne



to the only test that really matters . . . the EAR TEST

"The Standard
by Which
Others
Are Judged
and
Valued"

SPECIALIZATION

has made AUDAX a leader in its field. World-wide recognition such as ours could never "just happen". Rather it is the product of KNOW-HOW that comes only through years of specialization.

For twenty years—since pick-ups first became important commercially—the distinguished products of AUDAX have been SELECTED wherever the requirements were exacting.

The leadership which we have won the hard way will never be jeopardized by making pick-ups a side line. Of future MICRODYNE improvements—and of course we are planning them now—we can tell you one thing NOW:—They will uphold and carry forward the AUDAX quality tradition of *fac-simile* performance, regardless of external conditions.

Send for complimentary copy of
"PICK-UP FACTS"

AUDAX COMPANY

500 Fifth Avenue, New York 18

"Creators of Fine Electronic-Acoustical Apparatus since 1915"

Index to **electronics** Volume XVIII

January to December issues, inclusive, 1945

Cumulative Index (April 1930—December 1944) available at 75 cents

McGraw-Hill Publishing Company

330 West 42nd St., New York City, 18

A

Acoustics:

- Acoustics of small rooms and studios. Feb. *286
- Curve-tracer for acoustic device. R. K. HellmannDec. *130

Aeronautics:

- Army target plane controlled by radio transmitterDec. *300
- Automatic position indicator for aircraftMay *180
- Aviation's electronic requirements. D. W. RentzelOct. 288
- Civil Aeronautics Administration instrument landing system. The. Peter Caporale, pt. 1, Feb. *116; pt. 2Mar. *128
- Combination instrument for direction findingAug. *214
- Computing gunsight Model K-8. H. E. HaleJan. *94
- Electronic equipment for commercial aircraft. D. W. MooreJuly *184
- Electronic joy stick for large aircraft. June *156
- Electronic timer for aircraft de-icer. Blosser & HoltDec. *152
- Electronics in gunnery control for the B-29Jan. *190
- Fingertip control for formation flying. Taylor & VolkenantOct. *98
- Ground-controlled approach for aircraft. Capt. C. W. WatsonNov. *112
- High-frequency aircraft ignition systemDec. *264
- Human centrifugeApr. *95
- Liquid level indicator for aircraft industryJuly *152
- Magnetostriiction compass. R. G. RoweJuly *123
- Motor noise unit for aircraft trainer. B. E. PhelpsAug. *96
- Operational flight trainer uses 200 tubesFeb. *214
- Plane-to-ground radio telemetering. D. W. Moore, Jr.Nov. *125
- Temperature control in aircraft. Feb. *146
- Tympanometer developed to count a flier's swallowsSept. *192
- Universal electronic indicator for aircraftOct. 280
- Very high frequency omnidirectional radio rangesSept. *206

Amplifiers:

- AVC amplifiers for bridge null detectors. Lawrence FlemingJan. *198
- Amplifier theory applied to regulators. J. M. CagleJan. *140
- Audible audio distortion. H. H. Scott, Jan. *126
- Crystal-driven modulator for d-c amplifiers. J. A. WilliamsDec. *128
- D-c amplifier of high-current, low-impedance output. Lawrence FlemingAug. *212
- Photoelectric galvanometer amplifier. Gabrielle AssetFeb. *126
- Phototube amplifier. Lt. J. F. Scully, Oct. *168
- Stabilized negative impedance. E. L. Ginzton, pt. 1, July *140; pt. 2, Aug. *138; pt. 3Sept. *140
- Survey of d-c amplifiers. Maurice ArtztAug. *112
- Volume expander design. R. W. EhrlichDec. *124
- Zero phase shift amplifier design. L. R. MallingMar. *136

Antennas:

- Anti-fade antenna systemAug. 272
- Artificial antenna. Sidney Wald. Nov. *150
- Calculating antenna impedance. Jan. 268
- Frequency modulation antenna coupler. J. P. TaylorAug. *107

- Pretuned turnstile antenna. Brown & EpsteinJune *102
- Square-loop frequency modulation antenna. J. P. TaylorMar. *96
- Very high frequency dummy antenna. Stanley CutlerMay *129

Atomic Power:

- Facts about atomic powerSept. *238
- Technical basis of atomic explosives. Oct. *109

B

Broadcasting:

- Air terminal sound system. Brockway & BrockwayJune *138
- Audio mixer design. R. W. Crane, June *120
- Automatic fader. Dan HunterOct. *119
- Broadcast band satellite transmitters. R. H. SevilleJuly *94
- Canada's international short-wave plant. H. M. SmithSept. *112
- Chicago Stadium's broadcast systems. George McElrathJan. *116
- Planning a frequency modulation station. P. B. LaeserFeb. *92
- Post-war equipment plans for broadcastingJan. *92
- Reduction of heterodyne interference. H. W. BellesDec. *150
- Sixty kilowatts on wheels serves Signal CorpsJuly *208
- Studio and control-room design. W. R. HutchinsAug. *126

C

Cables:

- Coaxial cable design. N. D. Kenney, May *124

Capacitors:

- Contours of capacitor rotor plates. L. J. McDonaldMar. *126
- Determining Q of capacitors. E. L. PepperbergSept. *146
- Manufacture of silvered mica capacitors. A. T. ChapmanNov. *146

Carrier Currents:

- Carrier current versus space radio for railroadsFeb. *152

Cathode Ray Tubes:

- Armature faults found by cathode ray tubeJan. 234
- Cathode-ray tube solves production problemsDec. *234
- 50,000 hours for cathode-ray tube. May *192
- High-frequency deflection system. Dec. *332
- Improved electron gun for cathode-ray tubes. L. E. SwedlundMar. *122

Circuits:

- Discriminator linearity. L. B. ArguimbauMar. *142
- Dual-triode trigger circuits. B. E. PhelpsJuly *110
- Low-frequency multivibrators. Dec. *350
- Multiple magnetic circuits. J. F. ManfidiNov. *160
- Square-wave differentiating circuit analysis. G. P. OhmanAug. *132
- Stabilized negative impedances. E. L. Ginzton, pt. 1, July *140; pt. 2, Aug. *138; pt. 3Sept. *140
- * Illustrated

- Stabilized pulse circuitOct. *230
- Three-phase power from single-phase source. R. W. WoodsAug. *284
- Ultra high frequency converter analysis. Harry StockmanFeb. *140

Component Parts:

- Coaxial cable tests. P. H. WareOct. *130
- Computing mutual inductance. M. J. Di ToroJune *144
- Effects of humidity on terminal-strip design. L. L. George, Jr.Mar. *116
- Fungus and moisture protection for electronic equipment. Proskauer & SmithMay *119
- The engineer's place in distribution. Jan. 139
- High Q iron-cored inductor calculations. S. L. JavnaAug. *119
- High-speed components tester. Dec. *244
- Permeability of iron at radio frequenciesOct. 268
- Production tester for small values of capacitance. L. Y. HanopolSept. *160
- Stripping fine wire of formex insulationJan. 242
- Vibration control for electronic productsSept. *134
- Winding universal coils. A. W. Simon, Nov. 170

Controls:

- Automatic liquid level controls. T. A. CohenApr. *120
- Balancing operation speeded by motor controlOct. *154
- Built-in electronic control on milling machineApr. *150
- Computing gunsight Model K-8. H. E. HaleJan. *94
- Electronic control for magnetic clutches. R. L. JaeschkeAug. *102
- Electronics in gunnery control for the B-29Jan. *190
- Milling machine with built-in electronic controlAug. *150
- Phototube-controlled flame cutter. D. S. WalkerJuly *100
- Phototubes for railroad operations. July *152
- Practical electronic industrial controls. P. G. WeillerApr. *96
- Selsyn indicating systems for remote readings. F. WiskDec. *276
- Temperature control in aircraft. Feb. *146
- Transmitter-receiver in nose used to explode shells, rocketsNov. *110
- Vacuum-tube anticipator controls furnace temperaturesAug. *188

D

- Directory of electronic and allied productsNov. D-2

E

Electron Tubes:

- Australia—tubes at workJan. 234
- Case studies of production. Michael LechnerDec. *140
- Casting metal electrodes for vacuum tubesJan. 168
- Controlling activation schedules at exhaust. M. SilvermanSept. *180
- Disk-seal tubes. E. D. McArthur, Feb. *98
- Grid emission in vacuum tubes. Sorg & BeckerJuly *104
- Orbital-beam ultrahigh-frequency tubes. R. M. SmithMay *103
- Postwar electron tube business. W. C. WhiteSept. *92
- Phototube for ultravioletOct. 212

Pulse emission characteristics of oxide cathodes.....Sept.	*270
Quality control in tube manufacture. Eugene Goddess.....Jan.	*122
Report on wartime electronic developments.....Nov.	*92
Electron Tube Applications:	
Betatron, The. T. J. Wang.....June	*128
Electronic ignition systems. G. V. Eltgroth.....Apr.	*106
Highway radio control of truck traffic.....Dec.	*248
Lie detector. Dr. J. F. Kubis.....Apr.	*192
Non-metallic mine detector. T. E. Stewart.....Nov.	*100
Photoelectric Fourier analysis.....Apr.	*254
Phototimer for time-motion study.....Sept.	196
Phototubes for railroad operations.....July	*152
Traffic control system.....Sept.	*150

Electronic Heating:	
Automatic control of glazing furnace.....June	188
Characteristics of steel during induction heating.....June	*252
Chicago conference on induction and dielectric heating.....Mar.	*148
Defrosting food for bakeries.....June	*154
Dielectric fundamentals. Douglas Venable.....Nov.	*120
Dielectric heating in woodwork industry.....Apr.	180
Electronic welding of glass. E. M. Guyer.....June	*92
Induction and dielectric heating equipment.....Aug.	*110
Induction hardening. Otto Weitmann.....Mar.	*101
Induction heating in manufacture of cathode ray tubes.....Jan.	176
Load rematching in electronic heating. Eugene Mittelman.....Feb.	*110
Moulding sponge rubber with dielectric heating.....Aug.	196
Penicillin drying machine in production.....Sept.	*154
Shielding of dielectric heating installations. Klingaman & Williams.....May	*106
Unusual methods of applying electronic heat. E. D. Tillson.....Apr.	*150

F

Facsimile:	
Transmission of color pictures by facsimile.....Apr.	236
Filters:	
Band-pass filter design. C. J. Merchant.....Mar.	*146
Filters for electronic equipment. G. J. Wheeler.....July	*200
Harmonic suppression for aircraft generators. F. W. Jaksha.....Aug.	*124
High and low-pass filter design. C. L. Merchant.....Feb.	*144
Resistance-capacitance filter chart.....Nov.	*164

Frequency Allocation:	
Federal Communications Commission announces final Mc allocations.....July	92
FCC allocation plan.....Mar.	*92
FCC releases proposed allocations below 25,000 kc.....July	290

Frequency Modulation:	
Field survey techniques. P. B. Laeser.....May	*110
Pulse-time modulation. Deloraine & Labin.....Jan.	*100
Resonant circuit response to frequency modulation signal.....Feb.	*304
50-kw f-m transmitter. P. B. Laeser.....Apr.	*100

H

Hearing Aids:	
Deficiencies of group hearing aids. A. G. Norris.....Feb.	262
High Frequency:	
Measurement of very high frequency bursts.....Jan.	*105
Orbital-beam ultrahigh-frequency tubes. R. M. Smith.....May	*103

I

Industrial Electronics:	
Aniseikon for detection of cracks and flaws.....Jan.	172
Automatic metal pouring in foundries.....June	*152
Balls for bearings sorted by electronic gage.....Sept.	*192
Capacitor-discharge roll welder.....Dec.	*232

Circuit analyzers failure and how to avoid it. Ted Powell.....Oct.	*135
Crack detector for bottles and jars.....May	150
Crack detector for production testing. J. H. Jupe.....Oct.	*114
Electronic applications in industry (table).....May	92
Electrostatic deposition of phosphor powders.....Aug.	184
Gaging of piston rings.....May	*148
Increased speed for electronic recorders.....Aug.	*152
Infrared spectroscopy for rapid analysis.....Dec.	*232
Lens coating process controlled by electronics.....Jan.	*164
Mercury vapor detector.....Apr.	*176
Mobile testing of railroad rails.....Feb.	*146
Phototube-controlled flame cutter. D. S. Walker.....July	*100
Pipe gaskets tested for pressure.....July	*158
Production testing swivel joints.....Apr.	*184
Remote water-stage indicators. M. B. Kennedy.....Feb.	*130
Sandpaper made by electrostatic process.....Aug.	208
Tensile testing of textiles with electronic control.....June	*151
Vacuum-tube anticipator controls furnace temperatures.....Aug.	*188
Waterproofing radio and electronic equipment. E. C. Warrick.....Apr.	*212
Wire splice detector. F. S. Hird.....Sept.	*98

Institute of Radio Engineers:	
Meetings.....Jan. 252, Mar.	*198

M

Magnets:	
Magnetic current investigation.....Apr.	*266
Mathematics:	
Equivalent series and parallel impedances. R. L. Peek, Jr.....June	*254
Laplace transforms for the electronic engineer. G. J. Wheeler.....Feb.	*304
Parabolic graph paper for square-law functions. Albert Leon.....Feb.	*314
Pi-network calculator. W. H. Brune.....May	*140
Correction.....July	404
Vectorial treatment of transmission lines. J. P. Shanklin.....Dec.	*162

Measurements:	
A-c galvanometer. Quirk & Hall.....Dec.	*147
Automatic liquid level controls. T. A. Cohen.....Apr.	*120
Bridge null-indicator. E. W. Herold.....Oct.	*128
Cathode-ray null detector for Wien bridge. C. J. Markey.....Mar.	*125
Conversion from series to parallel impedance. G. J. Wheeler.....Oct.	*254
Curve tracer for acoustic device. R. K. Hellmann.....Dec.	*130
Decibel calculator. G. J. Wheeler.....Sept.	*294
Dielectric constant meter. F. C. Alexander, Jr.....Apr.	*116
Direct-indicating comparison bridge for production testing.....Dec.	*272
Direct-reading a-f meter.....Jan.	*264
Direct-reading color densitometer. M. H. Sweet.....Mar.	*102
Electronics aids waterway development. E. H. Woodman.....Sept.	*120
Electronic engine-pressure indicator. J. W. Head.....Jan.	*132
Electronic fuel gaging.....Dec.	*234
Electronic inspection of magnetic materials.....Feb.	*164
Electronic wattmeter. L. B. Malling.....Nov.	*133
Electronic width-gage for strip materials.....Feb.	*196
Elongation recorder for materials testing. Jens Sivertsen.....July	*154
Five r-f bridge circuits.....July	*264
Frequency meter for use by factory personnel. W. R. Strauss.....May	*150
Frequency monitor stroboscope. Wiggins & Guenther.....May	*138
Frequency-response curve tracer. H. B. Shaper.....Mar.	*118
Geiger counter spectrometer for industrial research. H. Friedman.....Apr.	*132
Generation of millimeter waves.....Sept.	298
Geophysical prospecting equipment. David Sheffer.....Dec.	*116
Graphical analysis of complex waves. L. S. Cole.....Oct.	*142
Improved vacuum-tube voltmeters. J. T. McCarthy.....July	*137
Industrial oscillograph for impulse testing. Otto Ackerman.....May	*154
Interference-free weatherometer. W. E. Agnew.....Dec.	*160
Liquid level indicator.....July	*152
Magnetostriction compass. R. G. Howe.....July	*123
Measurement applications of the dynatron. W. M. Ross.....Dec.	*320
Measurement of electric carrier.....Jan.	272
Measurement of stresses in rotating shafts. W. F. Curtis.....July	*114
Measurement of VHF.....Jan.	*106

Measuring radio frequency power with three ammeters. J. L. Hollis.....June	*142
Measuring temperature of steel.....Oct.	*164
Measuring uhf fields.....Apr.	*246
Microanalytic measurement of oxygen production.....Dec.	*340
Midget oscilloscope.....Sept.	*202
Millisecond timer for high speed operations.....Jan.	*148
Multiple X-Y recorder for testing quartz crystals. George Keinath.....Jan.	*106
Non-ferrous magnetometer.....Dec.	*330
Penetration measures thickness and density with gamma rays.....Aug.	*154
Photoelectric galvanometer amplifier. Gabrielle Asset.....Feb.	*126
Plane-to-ground radio telemetering. D. W. Moore, Jr.....Nov.	*125
Power measurements at very high frequencies. William Maron.....Oct.	*216
Practical strain-gage applications. R. O. Fehr.....Jan.	*112
Precision gaging by blind.....Oct.	*156
Pressure sensing unit developed from strain gage.....Dec.	*252
Production tester for small values of capacitance. L. Y. Hanopol.....Aug.	*160
Rapid technique for measuring line characteristics.....June	252
Reactor measurements. H. L. Daniels.....Oct.	*146
Recorded sound waves locate bomb hits.....Oct.	*218
Remote measurement and control with vibrating wire instrument.....June	*160
Resistance measurement at high impulse voltages. S. L. Shive.....Nov.	*158
Smoke density indicator and recorder.....Feb.	*148
Subsurface prospecting for hydrocarbon oil sands.....July	*252
Square-wave modulator.....Oct.	*260
Synthetic yarn measuring. Silverman & Ballou.....Feb.	*103
Testing lathe spindles for accuracy.....Aug.	150
Time-base calibration. W. W. Ludman.....Sept.	*117
Transient peak voltmeter. Ryerson & Aronson.....Sept.	*110
Tubeless probe for vacuum tube voltmeters. H. L. Daniels.....Feb.	*125
Tubes calibrate heavy artillery.....July	240
Turbidity measurement.....June	180
Tympanometer developed to count a flier's swallows.....Sept.	*192
Uhf impedance measurements. Marchand & Chapman.....June	*97
VHF impedance measurements. D. S. Henry.....Dec.	*156
Vibration meter for precision tap plant.....Jan.	*184

Medical Applications:	
Application of high-frequency phenomena in medicine.....Jan.	236
Electro-encephalograph detects brain waves.....Sept.	*234
Engineers discuss radar and surgical metal locator.....May	234
Medical probe. R. E. Ricketts.....Oct.	300
Tympanometer developed to count a flier's swallows.....Sept.	192
Microscope:	
Electron-microphotography of atoms.....Aug.	*276
Specimen stage for the electron microscope. Smith, Picard & Runge.....Feb.	*234
Techniques for electron microscopy.....Jan.	276

N

Networks:	
Artificial delay-line design. J. B. Trevor, Jr.....June	*135
Design of L-C phase-shift networks. R. W. Woods.....Apr.	*144
Woofer-tweeter crossover network. F. W. Klipsch.....Nov.	*144

O

Ordnance:	
Generator-powered proximity fuze. Hunston & Miller.....Dec.	*98
Machine gun rate-of-fire indicator. A. D. Peterson.....Dec.	*134
Transmitter-receiver in nose used to explode shells, rockets.....Nov.	*110
Wartime electronic developments.....Nov.	*92
Oscillators:	
Butterfly circuit in very high frequency oscillator.....Feb.	*216
Cathode-coupled oscillator circuit.....May	*234
Checking UHF oscillator stability. L. E. Pinney.....Dec.	*139
Design of stable heterodyne oscillators. J. B. Moore.....Oct.	*116
Double-beat oscillator for intermodulation measurements. H. H. Scott.....Jan.	*126
Oscillator for 25 c-m.....Jan.	*210

Timing action of the blocking oscillator. Emanuel Last. Oct. *184			
Variable frequency oscillator for 25 centimeters Jan. *210			
Wide-range generator with automatic amplitude. H. T. Stirling. May *210			
P			
Power Supply:			
Power supplies for photoelectric controls. Daniel Schulman. Feb. *177			
Power supply—two-voltage regulated. Oct. *254			
Q			
Quartz:			
Multiple X-Y recorder for testing quartz crystals. George Kelnath. Jan. *106			
Predimensioning quartz crystal plates. Haines, O'Neil & Robinson. June *112			
Quartz blanks multiplied by division. Mar. 196			
Quartz crystal improvements. C. W. Franklin. Aug. *130			
Quartz etching technique. L. A. Eibl. Jan. *120			
Test set for quartz crystals. W. E. McNatt. Apr. *113			
R			
Radar—see Radio Location			
Radio Communication:			
Drafting aids to relay profiling. F. H. Bingley. Dec. *216			
Future of citizens radio communication service. May 194			
Industrial control with intercommunicator. Sept. 156			
Microwave radio relay to replace telegraph lines. Dec. *300			
Microwave techniques. F. A. Jenks. Oct. *120			
Modulation by feedback. R. C. Shaw. Dec. *360			
Multi-channel high-speed communications. W. M. Ross. Aug. 238			
Radio for emergency use in mining operation. Aug. *152			
Radiotelephone for vehicles. Sept. 302			
Railway communications on 2660 mc. Dec. *256			
Rock Island Railroad radio tests. Ernest Dahl. May *96			
SCR-300 frequency modulation walkie-talkie. D. E. Noble. June *204			
Single-sideband generator. M. A. Honnell. Nov. *166			
Time division multiplex system. July *212			
Two-way radio for vehicles. Jan. 180			
Wire splice detector. F. S. Hird. Sept. *98			
Radio Location:			
Enemy radiosondes compared to ours. Feb. 224			
Fire-control radar MPG-1. H. A. Straus & others. Dec. *92			
Ground-controlled approach for aircraft. Capt. C. W. Watson. Nov. *112			
Loran system (Long Range Navigation). Pt. 1, Nov. *94; pt. 2. Dec. *110			
Radar equation. Apr. *92			
Radar fire hazard. Apr. 212			
Radar navigator for commercial shipping. Oct. *154			
Radar principles described by R. L. Smith-Rose. Mar. *180			
Radar SCR-268. Sept. *100			
Radar specifications. Nov. *116			
Radar terms and abbreviations. May 252			
Radar tube made in America. Sept. *230			
Radar warfare. Oct. *92			
SCR-584 radar. Pt. 1, Nov. *104; pt. 2. Dec. *104			
Ship-search radar for troopships. Dec. *260			
Sound equipment spots German guns. Feb. *226			
Tube for SCR-270 radar. Dec. *308			
VHF omnidirectional radio ranges. Sept. *206			
Receivers:			
Adopting f-m receivers to proposed FCC allocation. May *194			
Automatic gain control noise consideration in receiver design. J. B. Moore. May *116			
Crystal tuned f-m receivers. William Maron. Oct. *138			
Germany Army entertainment receiver. Capt. Gifford-Hull. June *216			
Improved bass for small radios. July *224			
Interference in f m receivers. R. N. Johnson. Sept. *129			
Permeability tuning. W. J. Polydoroff. Nov. *155			
Post-war receivers. J. H. Jupe. Oct. 234			
Receiver with 2 megacycle i-f amplifier. Harvey Kees. Apr. *129			
Remote tuning with reactance tubes. H. B. Bard Jr. Aug. *100			
Sensitivity limits in radio manufacturing. A. S. Blatterman. Nov. *141			
Suggestions for design of volume expanders. R. W. Crane. May *236			
Recording:			
Calculation of distortion due to phonograph needle wear. July *250			
Compressed recordings for carrier pigeons. July 220			
Crystal pickup compensation circuits. B. B. Bauer. Nov. *128			
High-speed code recording. Aug. *230			
Moving-coil pickup design. Theodore Lindenberg, Jr., June *108; discussion. Sept. 416			
Supersonic bias for magnetic recording. Holmes & Clark. July *126			
Tracing angle in phonograph pickups. B. B. Bauer. Mar. *110			
Two-speed turntable. Jan. *220			
Rectifiers:			
Gaseous rectifier circuits. P. T. Chin, pt. 1, Apr. *138; pt. 2. May *216			
Shunt diode for bias voltage. Sept. *216			
Wave-form demonstrator for controlled rectifier circuits. Chin & Moyer. Apr. *154			
Relays:			
Capacitance relay as punch press safety control. Jan. *172			
Relays in industrial tube circuits. U. R. Furst, pt. 2, Jan. *136; pt. 3, Feb. *133; correction. Apr. 438			
Suggested standards for telephone-type relays. A. W. Clement. Jan. *150			
Voice-operated electronic relay. Lt. C. J. Quirk. June *236			
S			
Supersonics:			
Supersonic bias for magnetic recording. Holmes & Clark. July *126			
Surplus equipment disposal. G. T. Montgomery. Aug. *92			
Symbols for electronic diagrams. Aug. *136			
T			
Television:			
Engineering aspects of television programming. V. M. Bradley. Mar. *107			
London letter. J. H. Jupe. Apr. 270			
Projection systems for television. May 218			
Restorer-circuit operation. Emanuel Last. Sept. *132			
Retractable c-r tube in recent television receiver. July *248			
Sensitive television camera tube. Dec. *330			
Television receiver symposium. Aug. 252			
VHF multiple-relay television network. F. J. Bingley. Oct. *102			
Training:			
Motor noise unit for aircraft trainer. B. E. Phelps. Aug. *96			
Navy radio-technical training. Ruth Lawyer. Sept. *278			
Simplified training for assembly-line workers. S. F. Auerbach. July *168			
Transformers:			
Coupling coefficient chart. L. E. Pepperberg. Jan. *144			
Hermetically sealed transformers. R. M. Hanson. Feb. *136			
Transmission Lines:			
Hyperbolic chart. P. H. Ware. Apr. *148			
Stroboscopic depiction of electron motion on transmission lines. J. F. Kline. June *258			
Transmission-line calculator. R. C. Paine. Mar. *140			
Transmission lines as tuning elements. H. E. Newell, Jr. Oct. *150			
Vectorial treatment of transmission lines. J. P. Shanklin. Dec. *162			
V			
Voltage Regulator:			
Electronic a-c voltage regulator. L. D. Harris. Dec. *147			
W			
Wave Guides:			
Circular wave guide fields. G. R. Cooper. Feb. *106			
Transmission line parameter for wave guide behavior. Apr. *246			
Welding:			
Electronic welding of glass. E. M. Guyer. June *92			
X			
X-rays:			
Electronic control of x-ray exposure time. Jan. *146			
Electronic x-ray current regulator. Mar. 176			
Industrial radiography. W. T. Sproull. June *122			
Industrial x-ray installations in Ford plant. May *148			
Industrial x-ray tubes. Z. J. Atlee. Nov. *136			
DISCUSSIONS RELATING TO 1944 ARTICLES			
Cathode follower calculations. H. P. Pacini, Oct. 1944, p. 137; discussion May 1945, p. 398. July 402			
Influence of feedback on source impedance. R. W. Crane, Sept. 1944, p. 122; correction. Jan. 382			
Neon counter for medical research. O. C. Gruner, Dec., 1944, p. 204. Aug. 426			
PI networks as coupled tank circuits. F. D. Schottland, Aug. 1944, p. 140; correction. Jan. 388			
RC oscillator performance. J. H. Hewitt, Mar. 1944, p. 128; correction. Jan. 399			
Secondary electron radiation. J. H. O. Harries, Sept., 1944, p. 100. Feb. 414			
AUTHORS' INDEX			
ACKERMAN, OTTO. Industrial oscillograph for impulse testing. May *154			
Agnew, W. Ritchie. Interference-free weatherometer. Dec. *160			
Alexander, Frank C., Jr. Dielectric constant meter. Apr. *116			
Arguimbau, L. B. Discriminator linearity. Mar. *142			
Aronson, M. & C. Ryerson. Transient peak voltmeter. Sept. *110			
Artzt, Maurice. Survey of d-c amplifiers. Aug. *112			
Asset, Gabrielle. A photoelectric galvanometer amplifier. Feb. *126			
Atlee, Z. J. Industrial x-ray tubes. Nov. *136			
Auerbach, S. Frederick. Simplified training for assembly-line workers. July *168			
BALLOU, J. W. & Shirleigh Silverman. Measuring the elasticity of synthetic yarns. Feb. *103			
Bauer, B. B. Crystal pickup compensation circuits. Nov. *128			
Tracking angle in phonograph pickups. Mar. *110			
Becker, George A. & H. E. Sorg. Grid emission in vacuum tubes. July *104			
Belles, H. W. Reduction of heterodyne interference. Dec. *150			
Beville, Ross H. Broadcast band satellite transmitters. July *94			
Bingley, F. J. Drafting aids to relay profiling. Dec. *316			
VHF multiple-relay television network. Oct. *102			
Blatterman, A. S. Sensitivity limited in radio manufacturing. Nov. *141			
Blosner, G. W. & G. R. Holt. Electronic timer for aircraft de-icer. Dec. *152			
Bradley, Virginia M. Engineering aspects of television programming. Mar. *107			
Brockway, Don C. & W. W. Brockway. Air terminal sound system. June *138			
Brown, George H. & J. Epstein. A re-tuned turnstile antenna. June *102			
Bruene, Warren B. Pi-network calculator. May *140			
Correction. July 404			
CAGE, JOHN M. Amplifier theory applied to regulators. Jan. *140			
Caporale, Peter. The Civil Aeronautics Administration instrument landing system, pt. 1, Feb. *116; pt. 2. Mar. *128			
Chapman, Aian T. Manufacture of silvered mica capacitors. Nov. *146			
Chapman, R. & N. Marchand. Ultra-high-frequency impedance measurements. June *97			
Chin, P. T. Gaseous rectifier circuits, pt. 1, Apr. *138; pt. 2. May *132			
Chin, P. T. & E. E. Moyer. Wave-form demonstrator for controlled circuits. Apr. *154			
Clark, Donald L. & L. C. Holmes. Supersonic bias for magnetic recording. July *126			
Clement, A. W. Suggested standards for telephone-type relays. Jan. *150			
Cohen, Theodore A. Automatic liquid level controls. Apr. *120			
Cole, Larry S. Graphical analysis of complex waves. Oct. *142			
Cooper, George R. Circular wave guide fields. Feb. *106			
Crane, Richard W. Audio mixer design. June *120			
Suggestions for design of volume expanders. May *236			
Curtis, W. F. Measurement of stresses in rotating shafts. July *114			
Cutler, Stanley. Very high frequency dummy antenna. Oct. *129			
DAHL, ERNEST. Rock Island Railroad radio test. May *96			
Daniels, Howard L. Reactor measurements. Oct. *146			
Tubeless probe for vacuum tube voltmeters. Feb. *125			
Davis, R. J. & others. Fire-control radar MPG-1. Dec. *92			

Deloraine, E. M. & E. Labin. Pulse-time modulation	Jan.	*100	Last, Emanuel. Restorer-circuit operation	Sept.	*132	Ryerson, C. & M. Aronson. Transient peak voltmeter	Sept.	110
DiToro, Michael J. Computing mutual inductance	June	*144	Lawyer, Ruth. Navy radio-technician training	Sept.	*278	SCHULMAN, DANIEL. Power supplies for photoelectric controls.	Feb.	*177
EGERT, S. S. Electronic sales engineering	June	111	Lechner, Michael. Case studies of production	Dec.	*140	Scott, H. H. Audible audio distortion.	Jan.	*126
Ehrlich, Lt. Robert W. Volume expander design	Dec.	*124	Leen, Albert. Parabolic graph paper for square-law functions	Feb.	*314	Scully, Lt. John F. Phototube amplifier	Oct.	*168
Eibl, L. A. Quartz etching technique.	Jan.	*120	Lindenberg, Theodore, Jr. Moving-coil pickup design	June	*108	Shanklin, J. P. Vectorial treatment of transmission lines	Dec.	*162
Eltgroth, G. V. Electronic ignition systems	Apr.	*106	Discussion	Sept.	416	Shaper, Harry B. Frequency-response curve tracer	Mar.	*118
Epstein, J. & G. H. Brown. A pretuned turnstile antenna	June	*102	Ludman, Walter W. Time-base calibration	Sept.	*117	Shaw, Robert C. Modulation by feedback	Dec.	*360
FEHR, R. O. Practical strain-gage applications	Jan.	*112	MALLING, L. R. Electronic wattmeter	Nov.	*133	Sheffet, David. Geophysical prospecting equipment	Dec.	*116
Fleming, Lawrence. AVC amplifiers for bridge null detector.	Jan.	*198	Zero phase shift amplifier design.	Mar.	*136	Shive, Scott L. Resistance measurement high impulse voltages.	Nov.	*158
D-c amplifier of high-current, low-impedance output	Aug.	*212	Manildi, Joseph F. Multiple magnetic circuits	Nov.	*160	Silverman, M. Controlling activation schedules at exhaust.	Sept.	*180
Frank, Ernest. Resistance-capacitance filter chart	Nov.	*164	Marchand, N. & R. Chapman. Ultra high frequency impedance measurements	June	*97	Silverman, Shirleigh & J. W. Ballou. Measuring the elasticity of synthetic yarns	Feb.	*103
Franklin, C. W. Quartz crystal improvements	Aug.	*130	Markey, Charles J. Cathode-ray null detector for Wien bridge.	Mar.	*125	Sivertsen, Jens. Elongation recorder for materials testing	July	*154
Friedman, H. Geiger counter spectrometer for industrial research.	Apr.	*132	Maron, William. Crystal-tuned f-m receivers	Oct.	*138	Simon, A. W. Winding universal coils.	Nov.	*170
Furst, Ulrich R. Relays in industrial tube circuits, pt. 2, Jan. *136; pt. 3, Feb. *133; correction.	Apr.	438	Power measurements at very high frequencies	Oct.	*216	Smith, H. E. & R. Proskauer. Fungus and moisture protection.	May	*119
GEORGE, LOUIS L. Jr. Effects of humidity on terminal-strip design	Mar.	*116	McArthur, E. D. Disk-seal tubes.	Feb.	*98	Smith, H. E. Canada's international short-wave plant	Sept.	*112
Gifford-Hull, Capt. German army entertainment receiver	June	*216	McCarthy, J. T. Improved vacuum-tube voltmeters	July	*137	Smith, Perry C., R. C. Picard & F. E. Runge. Specimen stage for the electron microscope	Feb.	*234
Ginzton, E. L. Stabilized negative impedances, pt. 1, July *140; pt. 2, Aug. *138; pt. 3, Sept.	Sept.	*140	McDonald, Lyell J. Contours of capacitor rotor plates	Mar.	*126	Smith, R. M. Orbital-beam ultrahigh-frequency tubes	May	*103
Goddess, Eugene. Quality control in tube manufacture	Jan.	*122	McElrath, George. Broadcasting political conventions	Jan.	*116	Smith-Rose, R. L. Radar principles described	Mar.	*180
Guenther, S. G. & W. S. Wiggins. Frequency monitor stroboscope.	May	*138	McNatt, W. E. Test set for quartz crystals	Apr.	*113	Sorg, Harold E. & G. A. Becker. Grid emission in vacuum tubes.	July	*104
Guyer, E. M. Electronic welding of glass	June	*92	Merchant, C. J. Band-pass filter design	Mar.	*146	Sproull, Wayne T. Industrial radiography	June	*122
HAINES, B. P., C. D. O'Neal, & S. A. Robinson. Predimensioning quartz crystal plates.	June	*112	High and low-pass filter design.	Feb.	*144	Steele, William H. Electrolysis prevention on underground pipe.	June	*192
Hale, H. Erwin. The K-8 computing gunsight	Jan.	*94	Miller, B. J. & R. D. Huntoon. Generator-powered proximity fuze.	Dec.	*98	Stewart, T. E. Non-metallic mine detector	Nov.	*100
Hall, Henry D. & A. L. Quirk. A-c galvanometer	Dec.	*147	Mittelman, Eugene. Load rematching in electronic heating	Feb.	*110	Stirling, Howard T. Wide range signal generator with automatic amplitude control	May	*210
Hanopol, L. Y. Production tester for small values of capacitance.	Sept.	*160	Montgomery, G. T. Surplus equipment disposal plan	Aug.	*92	Stockman, Harry. Ultra high frequency converter analysis	Feb.	*140
Hanson, Robert M. Hermetically sealed transformers	Feb.	*137	Moore, David W. Electronic equipment for commercial aircraft.	July	*184	Straus, H. A. & others. Fire-control radar MPG-1	Dec.	*92
Harris, Prof. L. Dale. Electronic a-c voltage regulator	Dec.	*147	Plane-to-ground radio telemetering.	Nov.	*125	Strauss, W. R. Frequency meter for use by factory personnel.	May	*150
Head, J. W. Electronic engine-pressure indicator	Jan.	*137	Moore, John B. Automatic gain control noise consideration in receiver design	May	*116	Swedlund, L. E. Improved electron gun for cathode-ray tubes.	*122	
Hellmann, R. K. Curve-tracer for acoustic device	Dec.	*130	Design of stable heterodyne oscillators	Oct.	*116	Sweet, Monroe H. Direct-reading color densitometer	Mar.	*102
Henry, D. Stanley. VHF impedance measurements	Dec.	*156	Moyer, E. E. & P. T. Chin. Wave-form demonstrator for controller rectifier circuits	Apr.	*154	TAYLOR, D. G. & Gordon Volkenant. Fingertip control for formation flying	Oct.	*98
Herold, E. W. Bridge null-indicator.	Oct.	*128	NEWELL, H. E., Jr. Transmission lines as tuning elements	*150		Taylor, J. H. & others. Fire-control radar MPG-1	Dec.	*92
Hird, F. S. Wire splice detector.	Sept.	*98	Noble, Daniel E. Details of the SCR-300 frequency modulation walkie-talkie	June	*204	Taylor, John P. F-in antenna coupler.	Aug.	*107
Hollis, J. L. Measuring radio frequency power with three ammeters.	June	*142	Norris, Arthur G. Deficiencies of group hearing aids	Feb.	*262	Square-loop frequency modulation antenna	Mar.	*96
Holmes, Lynn C. & D. L. Clark. Super-sonic bias for magnetic recording	July	*126	OHMAN, G. P. Square-wave differentiating circuit analysis.	Aug.	*132	Taylor, M. & others. Fire-control radar MPG-1	Dec.	*92
Holt, G. R. & G. W. Blosser. Electronic timer for aircraft de-icer.	Dec.	*152	O'Neal, C. D., B. P. Haines & S. A. Robinson. Predimensioning quartz crystal plates	June	*112	Tillson, E. D. Unusual methods of applying electronic heat.	Apr.	*150
Honnell, M. A. Single-sideband generator	Nov.	*166	PAINE, ROBERT C. Transmission-line calculator	Mar.	*140	Trevor, J. B., Jr. Artificial delay-line design	June	*135
Hunter, Dan. Automatic fader.	Oct.	*119	Peek, R. L., Jr. Equivalent series and parallel impedances	June	*254	VENABLE, DOUGLAS. Dielectric heating fundamentals	Nov.	*120
Huntoon, R. D. & B. J. Miller. Generator-powered proximity fuze.	Dec.	*98	Pepperberg, E. L. Determining Q of capacitors	Sept.	*146	Volkenant, Gordon & D. G. Taylor. Fingertip control for formation flying	Oct.	*98
Hutchins, William Reach. Studio and control-room design	Aug.	*126	Coupling coefficient chart.	Jan.	*144	WALD, SIDNEY. Artificial antenna.	Nov.	*150
IYES, RONALD L. Improved socket-punch wrenches	Oct.	*204	Peterson, Arvid D. Machine gun rate-of-fire indicator	Dec.	*134	Walker, David S. Phototube-controlled flame cutter	July	*100
JAESCHKE, RALPH L. Electronic control for magnetic clutches.	Aug.	*102	Phelps, Byron E. Dual-triode trigger circuits	July	*110	Wang, Theodore J. The Betatron.	June	*128
Jaksha, F. W. Harmonic suppression for aircraft generators	Aug.	*124	Motor noise unit for aircraft trainer	Aug.	*96	Ware, Perry H. Coaxial cable tests.	Oct.	*130
Javua, Stephen L. High Q iron-cored inductor calculations	Aug.	*119	Picard, Robert G., P. C. Smith & F. E. Runge. Specimen stage for the electron microscope	Feb.	*234	Hyperbolic chart	Apr.	*148
Jenks, Frederic A. Microwave techniques	Oct.	*120	Pinney, L. E. Checking UHF oscillator stability	Dec.	*139	Warrick, Edward C. Waterproofing radio and electronic equipment.	Apr.	*212
Johnson, Robert N. Interference in frequency-modulation receivers	Sept.	*129	Polydoroff, W. J. Permeability tuning.	Nov.	*155	Watson, Capt. C. W. Ground-controlled approach for aircraft.	Nov.	*112
Jupe, John H. Crack detector for production testing	Oct.	*114	Powell, Ted. Industrial test equipment design	Oct.	*135	Weiller, Paul G. Practical electronic industrial controls	Apr.	*96
London letter	Apr.	270	Proskauer, R. & H. E. Smith. Fungus and moisture protection	May	*119	Weitmann, Otto. Induction hardening	Mar.	*101
Post-war receivers	Oct.	234	QUIRK, Arthur L. & H. D. Hall, A-c Galvanometer	Dec.	*147	Wert, C. A. & others. Fire-control radar MPG-1	Dec.	*92
KEES, HARVEY. Receiver with 2 megacycle i-f amplifier.	Apr.	*129	Quirk, Lt. Carl J. Voice-operated electronic relay	June	*236	Wheeler, Gershon J. Conversion from series to parallel impedance.	Oct.	*254
Keinath, George. Multiple X-Y recorder for testing quartz crystals.	Jan.	*106	REISMAN, S. J. & others. Fire-control radar MPG-1	Dec.	*92	Decibel calculator	Sept.	*294
Kennedy, Maurice E. Remote water-stage indicators	Feb.	*130	Rentzel, D. W. Aviation's electronic requirements	Oct.	288	Filters for electronic equipment.	July	*200
Kennedy, N. D. Coaxial cable design.	May	*124	Ricketts, Robert E. Medical probe.	Oct.	300	Laplace transforms for the electronic engineer	Feb.	*304
Kline, J. F. Stroboscopic depiction of electron motion on transmission lines	June	*258	Robinson, S. A., B. P. Haines & C. D. O'Neal. Predimensioning quartz crystal plates	June	*112	White, W. C. Postwar electron tube business	Sept.	*92
Klingaman, G. W. & G. H. Williams. Shielding of dielectric heating installations	May	*106	Ross, Wayne M. Measurement applications of the dynatron.	Dec.	*320	Wiggins, Wallace S. & S. G. Guenther. Frequency monitor stroboscope.	May	*138
Klipsch, Paul W. Woofer-tweeter crossover network	Nov.	*144	Multi-channel high-speed communications with standard radio equipment	Aug.	238	Williams, G. H. & G. W. Klingaman. Shielding of dielectric heating installations	May	*106
Kubis, Dr. Joseph F. Electronic detection of deception.	Apr.	*192	Rowe, R. G. Magnetostriction compass	July	*123	Williams, James A. Crystal-driven modulator for d-c amplifiers.	Dec.	*128
LABIN, E. & E. M. Deloraine. Pulse-time modulation	Jan.	*100	Rueger, L. J. & others. Fire-control radar MPG-1	Dec.	*92	Wisk, F. Selsyn indicating systems for remote readings	Dec.	*276
Laeser, Phil B. Frequency-modulation field survey techniques.	May	*110	Runge, Frank E., P. C. Smith & R. G. Picard. Specimen stage for the electron microscope	Feb.	*234	Woodman, Eugene H. Electronics aids waterway development	Sept.	*110
Planning a frequency-modulation station	Feb.	*92				Woods, Robert W. Design of L-C phase-shift networks	Apr.	*144
						Three-phase power from single-phase source	Aug.	*284

First aid to hearing with wire insulation of Geon



*Polyvinyl resins are superior materials
for ALL types of wire and cable insulation*

Many of the properties that make wire insulation of GEON a superior material for hearing aid cord are the same ones that have brought about its wide use in wiring of all kinds, public utilities, and in manufacturing, and fabrication in every field.

For example, it resists body oils—won't get gummy. (*It resists most other chemicals, too; oils, greases, acids, alkalis.*) It's long aging—resists the action of air, ozone, sun, heat, cold.

(*Ideal for radio connector cord, switchboards, etc.*) It's light in weight—made possible by thin coatings.

(*That means more conductors per conduit in domestic, industrial, or utility wiring.*) It's smooth and comfortable. (*Easy to handle, easy to install.*) It has high flexlife. (*Use it anywhere that there's vibration or frequent flexing.*)

Of course, all of these are in addition to excellent electrical properties that make possible power cable without protective sheathing; buried service entrance wire, and many other severe—or routine—forms of service.

The next time you order wire or cable be sure to specify insulation made from GEON. That way you'll be sure to get the best. For further information write Department FF-12, B. F. Goodrich Chemical Company, Rose Building, Cleveland 15, Ohio.



B. F. Goodrich Chemical Company

A DIVISION OF
THE B. F. GOODRICH COMPANY

DAVEN

VOLUME LEVEL INDICATORS

DAVEN Volume Level Indicators are designed to indicate audio levels in broadcasting, sound recording and allied fields. Extremely sensitive, they are sturdily constructed and correctly damped for precise monitoring. The long, specialized experience of DAVEN in the design and development of test equipment makes these Indicators the preference of major sound engineers both here and abroad.

TYPE 920
Rack model, low-level bridging type. Meter multiplier range: -20 VU to +20 VU. Power supply, 100-130 V, 60 cycle AC, with voltage regulator for normal variations. Reference level: 1 mw into 600 ohms.



TYPE 913
Rack model, terminating and bridging type. Meter multiplier ranges: terminating, -6 VU to +32 VU; bridging, +4 VU to +42 VU; or terminating, -6 VU to +16 VU bridging, +4 VU to +26 VU. 2 VU steps. Reference level: 1 mw into 600 ohms.

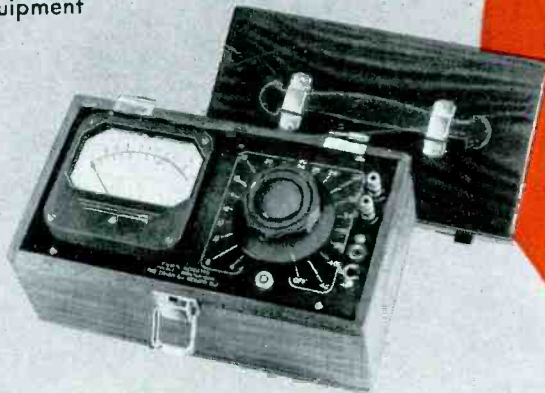

TYPE 911
Portable model, bridging type. Meter multiplier range: +4 VU to +42 VU or +4 VU to +26 VU, 2 VU steps. Reference level: 1mw into 600 ohms.

TYPE 910
Rack model; same as Type 911.



GENERAL SPECIFICATIONS

INPUT IMPEDANCE: Bridging, 7500 ohms; terminating, 600 ohms, excepting Type 185-1581 ohms, bridging.

FREQUENCY RANGE: Less than 0.2 db up to 10,000 c.p.s. Type 920, less than 0.2 db, 30 up to 15,000 c.p.s.

METER SCALE: -20 to +3 VU and 0 to 100%. Type A scale has VU reading on upper scale; Type B scale has percentage reading on upper scale.

INDICATING METER: Copper-Oxide type, adjusted for deliberate pointer action.

METER ADJUSTMENT CONTROL: Miniature step type; ± 0.5 db range, in 0.1 db steps.

MOUNTING: Rack models 19" long for standard relay rack; portable models in walnut cabinet, approx. 11"x6"x6 1/4".

TYPE 185
Power Level Indicator, portable or rack models, bridging type. Meter multiplier range: -10 db to +46 db. Reference level: 6 mw into 500 ohms.

THE **DAVEN** COMPANY
191 CENTRAL AVENUE
NEWARK 4, NEW JERSEY

Have you a Daven Catalog in your files?

RCA Tube Plant, Lancaster, Penna.
RCA manufactures cathode-ray tubes, as well
as power tubes, in this modern plant.

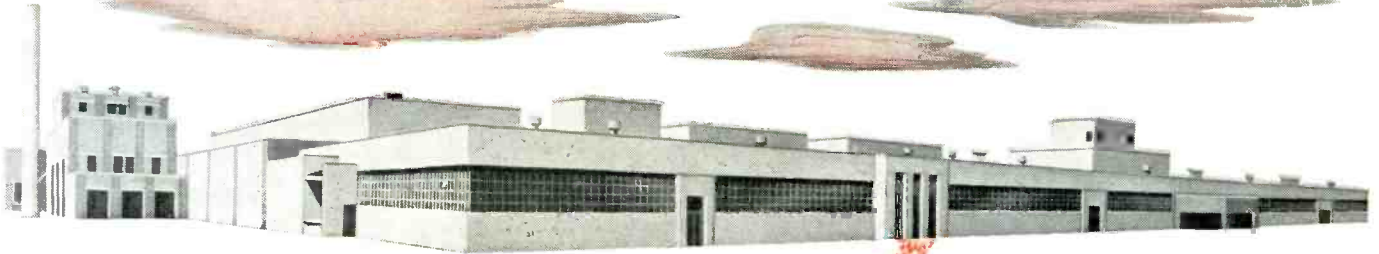

Last year the production of
POWER TUBES
by the Tube Division of RCA
was greater than that of
any other manufacturer in the world

THE FOUNTAINHEAD OF MODERN
TUBE DEVELOPMENT IS RCA



62-6136-37

RADIO CORPORATION OF AMERICA

TUBE DIVISION • HARRISON, N. J.